



indoor

built-up

2







1992  
2020

**a passion for lighting**

for

28

years

## AANDACHTSPUNTEN:

### ***Psmighting is 100% Belgisch!***

Alle opgegeven wattages, vermeld bij de verlichtingsarmaturen, zijn de maximum waarden en dienen eventueel aangepast te worden naar een lager wattage naargelang de plaats waar het toestel wordt geïnstalleerd.

Alle verlichtingsarmaturen dienen geplaatst en aangesloten te worden door een erkend elektricien die de nodige kennis en ervaring heeft, alsook vergunning voor het plaatsen van onze armaturen. Dit dient ook altijd te gebeuren volgens de geldende reglementering en officiële instructies. De installateur is ervoor verantwoordelijk dat de gebruikte voorschakelapparatuur voldoet aan de geldende CE-norm.

De afmetingen van de verlichtingsarmaturen kunnen te allen tijde worden aangepast indien wij dit nodig achten. Hiervoor kan dus geen schadevergoeding worden geëist. De aangegeven hoogtes zijn niet bindend, deze zijn variabel naargelang het gekozen lamptype.

De opgegeven prijzen kunnen te allen tijde aangepast worden en dit ten gevolge van schommelingen in grondstof prijzen. Prijsstijgingen zullen 3 maanden vooraf op onze website [www.psmighting.be](http://www.psmighting.be) worden aangekondigd. Prijzen die per abuis foutief in deze catalogoog staan worden ook op onze website in een errata vermeld.

### **Belangrijk bij ontvangst goederen:**

Nazicht van de verpakking  
Nazicht van het aantal ontvangen colli's (vooraleer wordt ondertekend voor ontvangst)

## POINTS PRIORITAIRES:

### ***Psmighting est 100% belge!***

Toutes puissances en Watts, mentionnées dans le catalogue, sont les valeurs les maximum et doivent être adaptées selon la place d'installation de l'armature.

Le placement, le raccordement et l'essai des armatures doivent toujours être effectués par un installateur électricien agréé, qui a la connaissance et l'expérience, suivant le règlement sur les installations électriques en vigueur. L'installateur est responsable de l'utilisation des ballasts, transfos, conformes aux normes CE et EMC.

Les dimensions des armatures peuvent être changées à tout moment quand nous le trouvons nécessaire. Il est donc hors question de demander d'indemnité.

Les hauteurs mentionnées dans le catalogue ne sont pas contraignantes, celles-ci sont variables selon le type de lampe choisi.

Les prix mentionnés peuvent être changés à tout moment à cause des variations de prix des matières premières. Les hausses de prix seront annoncées sur notre site web 3 mois en avance.

Des prix qui sont mis faux accidentellement dans le catalogue seront mis dans un errata sur le site web.

### **Important en cas de réception de marchandises:**

Vérification de l'emballage  
Vérification du nombre de colis (avant de signer pour réception des marchandises)

## POINTS THAT REQUIRE SPECIAL ATTENTION:

### ***Psmighting is 100% Belgian!***

All wattages mentioned in the catalogue are maximum values and are to be changed to lower wattages according to the place where the lighting fixture is installed.

All lighting fixtures need to be installed and connected by an acknowledged electrician, who has the necessary knowledge and experience, including a license to install our lighting fixtures. This has to be done according to the valid CE and EMC regulations. The used ballasts have to meet these regulations as well.

The dimensions of the lighting fixtures can be changed at any time without prior notice if we think it is necessary. It is out of the question to get a compensation afterwards. Heights mentioned in this catalogue are not binding. These can vary according to the chosen lamp type.

The prices in the pricelist can change at any time and this due to price fluctuations of the raw materials. Price increase will be announced on our website 3 months in advance. False prices that are accidentally put in the pricelist will be mentioned correctly on the website in an errata

### **Important in case of reception of the goods:**

Check-up of the packaging  
Check-up of the number of parcels (before signing for receipt)

## SCHWERPUNKTE:

### ***Psmighting ist 100% belgisch!***

Alle Wattleistungen bei der Leuchten sind Höchstwerte. Diese sollen zu einer geringeren Wattleistung je nach dem Platz der Leuchte angepasst werden.

Alle Leuchten müssen von einem autorisierten Elektro-Fachmann montiert und angeschlossen werden, der die übliche Kenntnisse und Erfahrung hat, sowie eine vorherige Genehmigung um unsere Leuchten zu montieren. Der Installateur ist dafür verantwortlich, dass das verwendete Vorschaltgerät der geltenden CE-Norm entspricht, einschließlich der elektromagnetischen Kompatibilität.

Die Abmessungen der Leuchten können jederzeit angepasst werden, wenn wir das für notwendig halten. Es ist unmöglich dafür Schadenersatz zu bekommen. Die angedeutete Höhen sind nicht bindend. Diese sind variabel je nach dem gewählten Lampentyp.

Die erwähnten Preise können jederzeit angepasst werden auf Grund der Preisschwankungen der Rohstoffe. Preiserhöhungen werden immer 3 Monate im voraus auf unserer Website gemeldet. Falsche Preise im Katalog werden auch in einer Korrekturliste auf der Website veröffentlicht.

### **Wichtig beim Empfang der Güter:**

Überprüfung der Verpackung  
Überprüfung der Anzahl der Frachtstücke (bevor Unterzeichnung für Empfang)



LOOKBOOK  
ACCESSORIES

10-17  
18-133

ACCESSORIES

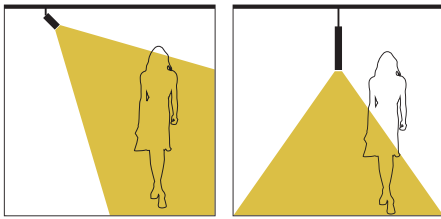

CEILING UP

SPOTS  
PENDANTS  
LUMINAIRES  
PROFILES  
SYSTEM UP

134-175  
176-355  
356-491  
492-515  
516-557



CEILING UP

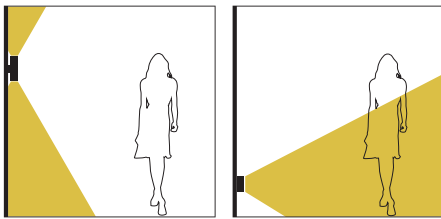

WALL UP

558-661



WALL UP

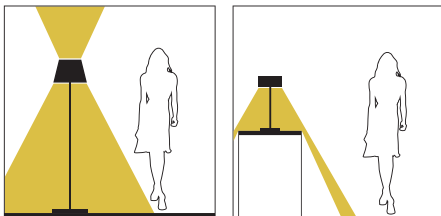

FLOOR UP

662-699



FLOOR UP

DRIVERS- CONTROL

700-727

DRIVERS

INDEX

728-760

INDEX

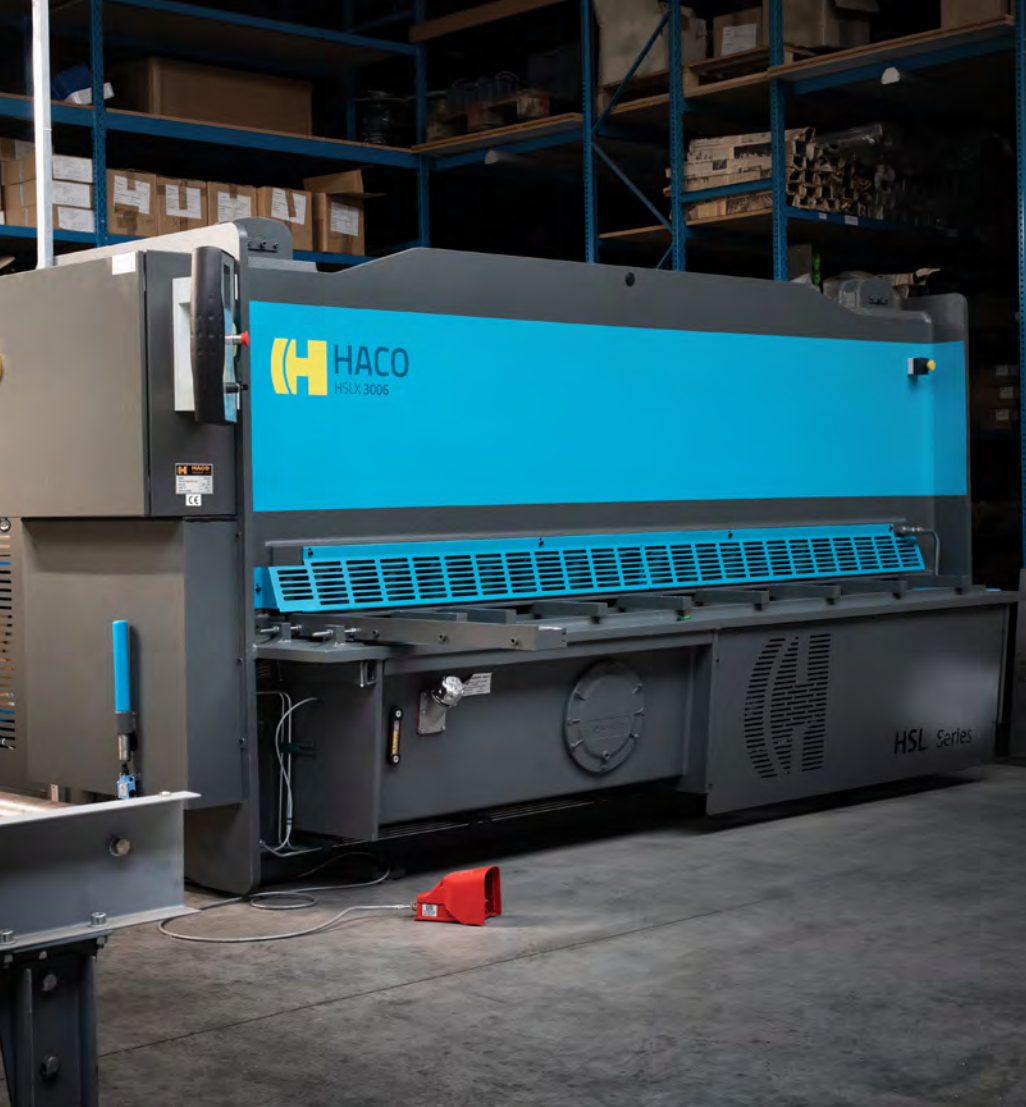











# INDOOR LOOKBOOK







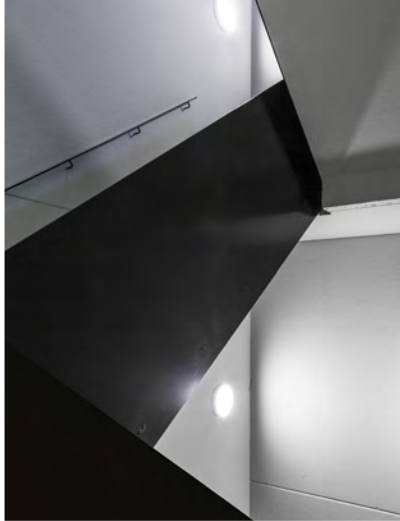

Timeless designs.





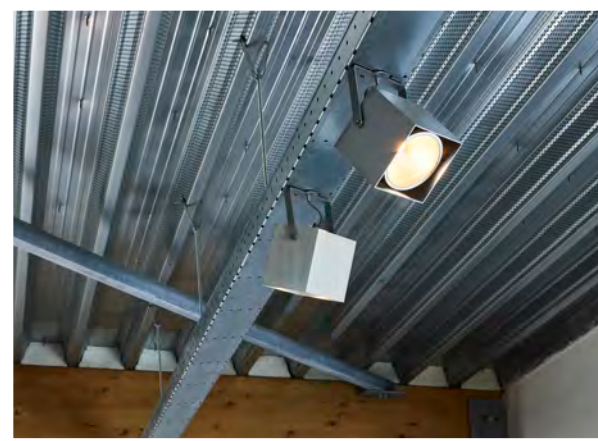
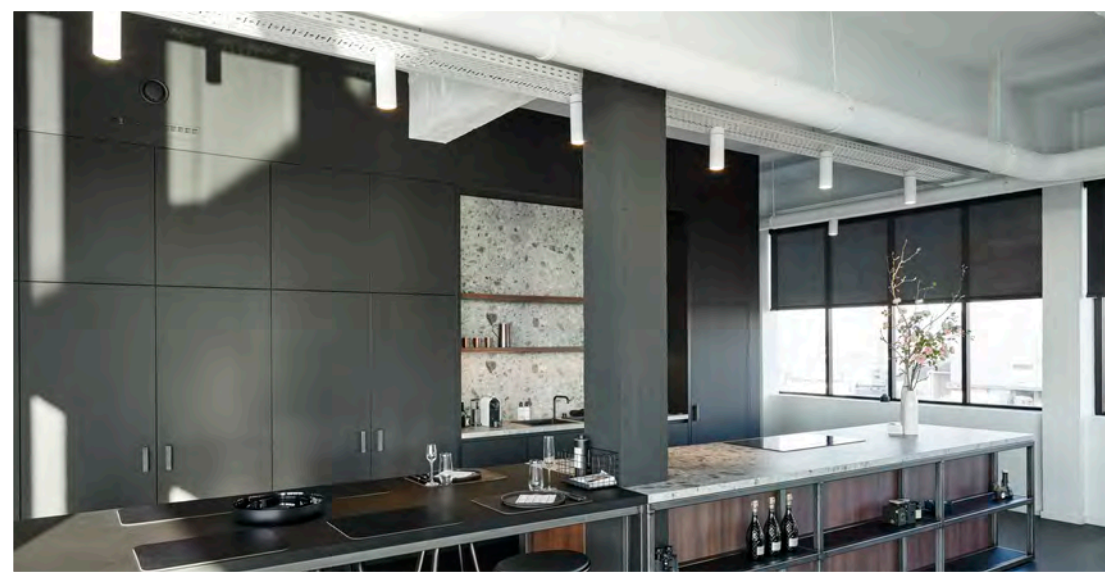
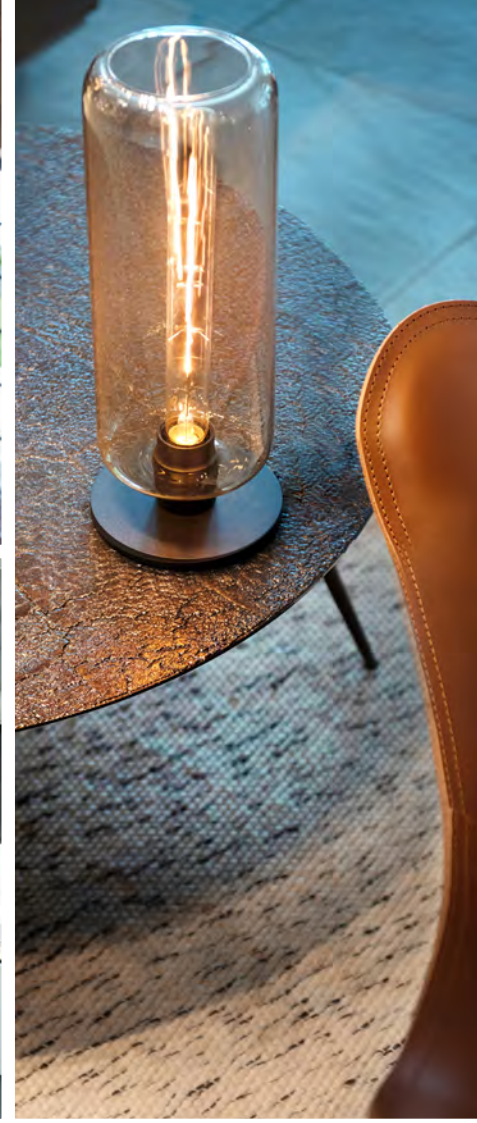
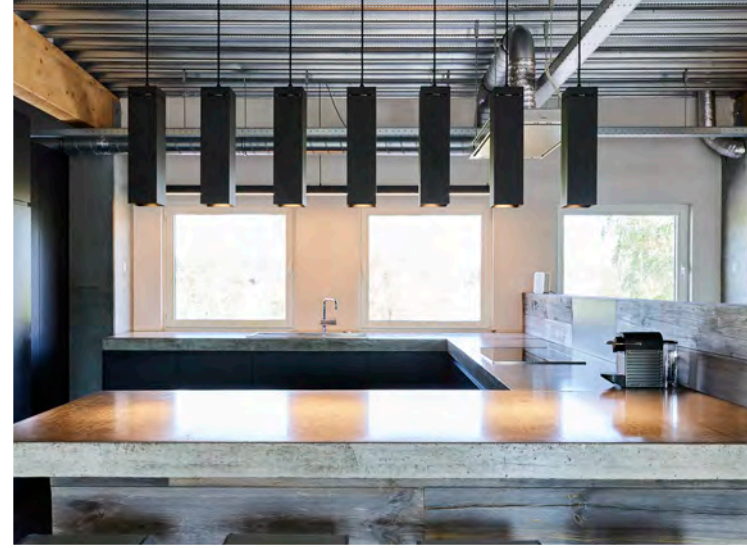

28 years  
of experience.

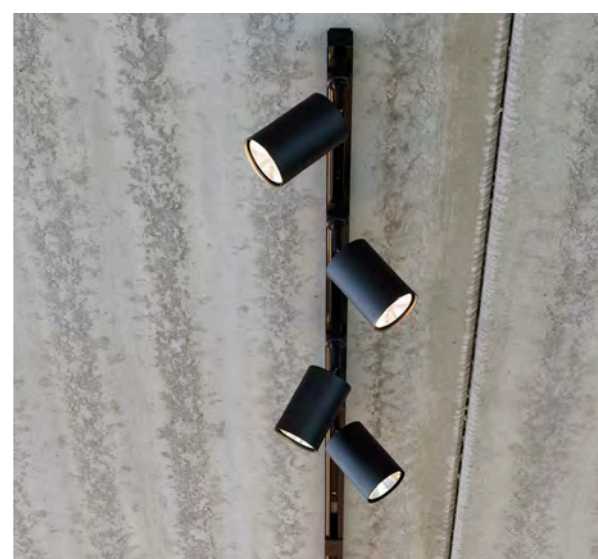





Suits  
every  
interior.







100% Belgian quality.







100% hand made design.







Professional lighting advice.

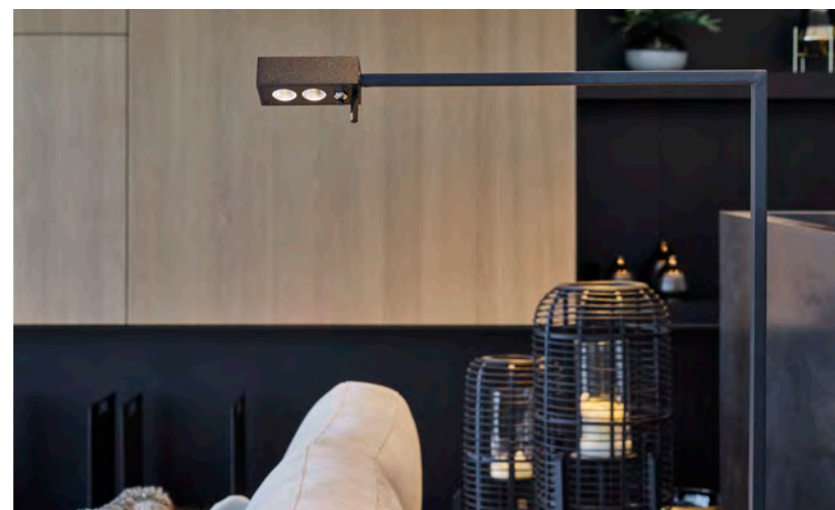
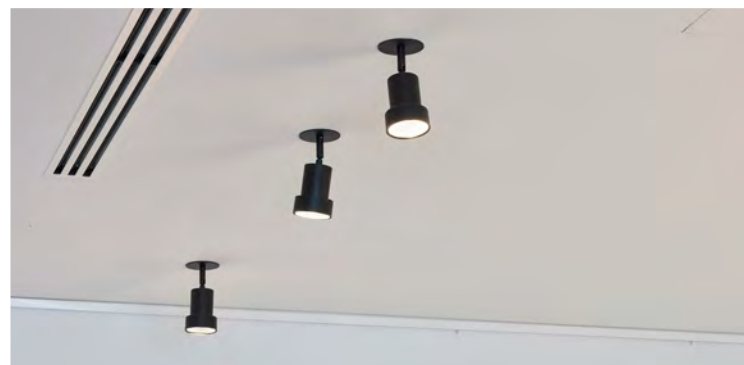



# INDOOR ACCESSORIES

## Index

**B**

BASIS OPBOUWSPOT 105-109

**C**

CABLE 27-28

CHAIN- KETTING POLO 28

CIRCUIT 29

CONNECTOR 44

CONNECTOR FOR TRACKS 47

CONVERTIBLE SYSTEM 21

**D**

DECENTRALISATIESTEUN 44

DEMO TEXTIELCABLE 112

DEMOWAAIER/.. 112

**F**

FILTER 22

**J**

JUBA 78-84

**K**

KNEEJOINT 46

**L**

LEDMODULE 114-116

LUXOR UP 100

**M**

MAESTRO 86-87

METRO 27-29

**N**

NOVA/.. 117

NOVA LED LENS 118

**O**

OVALE BOX 75-76

**P**

P039/.. 42-110

P040/.. 43-110

**R**

RAL COLOUR 20

RONDO BOX 68-74

ROSETTE IN B3 35-36-40-41

ROSETTE IN M10 30-41

ROSETTE IN SCREWS 37

ROSETTE UP TX 49-55

ROSETTE UP HOOK 66-67

ROSETTE UP B3 60-62-65-67

ROSETTE UP M10 56-59-63-65

ROSETTE UP M12 57

**S**

SET TORSION SPRINGS 21

SET FLAT SPRINGS 21

S.EXTRACIRCUIT/.. 29

SQUARE 230V 96-98

STAALKABEL 28

STELLA 77

STRAIN RELIEF 42-43-110

**T**

TEXO 88-94

TEXTILE CABLE 23-26

TRACK 1FASE 120-125

TRACK 3 FASE 126-131

TRACK 48V 132-133

TRANSFORMER BOX 63

**Z**

ZOOM 102-104

003.RALSTOCK/.. - RAL COLOUR STOCK



supplement - fixed price RAL colour NET PRICE!  
 Supplement - Preis für RAL Farbe gilt als NETTOPREIS!

Ref cat (NET)

003.RALSTOCK[HG]  
 003.RALSTOCK[MT]  
 003.RALSTOCK[ST]  
 003.RALSTOCK[TX]

003RALNOSTOCK/.. - 003.RAL NO STOCK



supplement - fixed price RAL colour NET PRICE!  
 Supplement - Preis für RAL Farbe gilt als NETTOPREIS!

Ref

003RALNOSTOCK

003.NCS/.. - NCS COLOUR



supplement - fixed price NCS colour NET PRICE!  
 Supplement - Preis für NCS Farbe gilt als NETTOPREIS!

Ref

003.NCS



**S1/.. - SET TORSION SPRINGS**

IP20    



supplement - set torsion springs  
Supplement - Set Torsionfedern

Ref  
S1

*built-in*

**S2/.. - SET FLAT SPRINGS**

IP20    

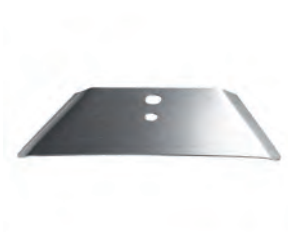

supplement - set flat springs  
Supplement - Set Blattfedern

Ref  
S2

*built-in*

**S5/.. - CONVERTIBLE SYSTEM**

IP20    



accessory for downlight - strain relief terminal  
Zubehör für Einbaustrahler - Anschlußklemme mit  
Zugentlastung

Ref  
S5

**Dimensions**

↔ H75

*only for roundbase  
Nur für Roundbase*

F50/.. - FILTER

IP20  



Dimensions  
↔ Ø50xH4

Ref  
F50

F70/.. - FILTER

IP20  



Dimensions  
↔ Ø70xH5

Ref  
F70

F111/.. - FILTER

IP20  



Dimensions  
↔ Ø111xH5

Ref  
F111



TXST/.. - TEXTILE STANDARD CABLE

IP20   

Ref

TXST.TX1	white
TXST.TX2	black
TXST.TX3	red
TXST.TX4	gold
TXST.TX6	orange
TXST.TX7	mouse grey
TXST.TX8	whisky
TXST.TX10	yellow
TXST.TX11	alu grey
TXST.TX12	glitter sand
TXST.TX13	bronze
TXST.TX15	beige
TXST.TX19	light blue
TXST.TX23	brown
TXST.TX30	pink
TXST.TX31	raspberry red
TXST.TX33	mocha
TXST.TX34	kaki
TXST.TX36	green cable
TXST.TX37	bordeaux
TXST.TX38	fuchsia
TXST.TX39	fluo yellow
TXST.TX40	lilac
TXST.TX43	soft bronze
TXST.TX44	dark gray
TXST.TX56	jeans
TXST.TX57	petrol
TXST.TX70	light grey
TXST.TX81	ochre
TXST.TX82	lemon yellow
TXST.TX191	dark blue
TXST.TX192	pastel blue
TXST.TX193	ocean blue
TXST.TX194	Turkish blue
TXST.TX362	mint green
TXST.TX364	leaf green
TXST.TXJ	jute
TXST.TXJX	blue jeans

textielkabel 3x0,75 /m - max. gewicht 3kg  
 textile cable 3x0,75 /m - max. weight 3kg  
 textielkabel 3x0,75 /m - max. gewicht 3kg  
 textile cable 3x0,75 /m - max. weight 3kg

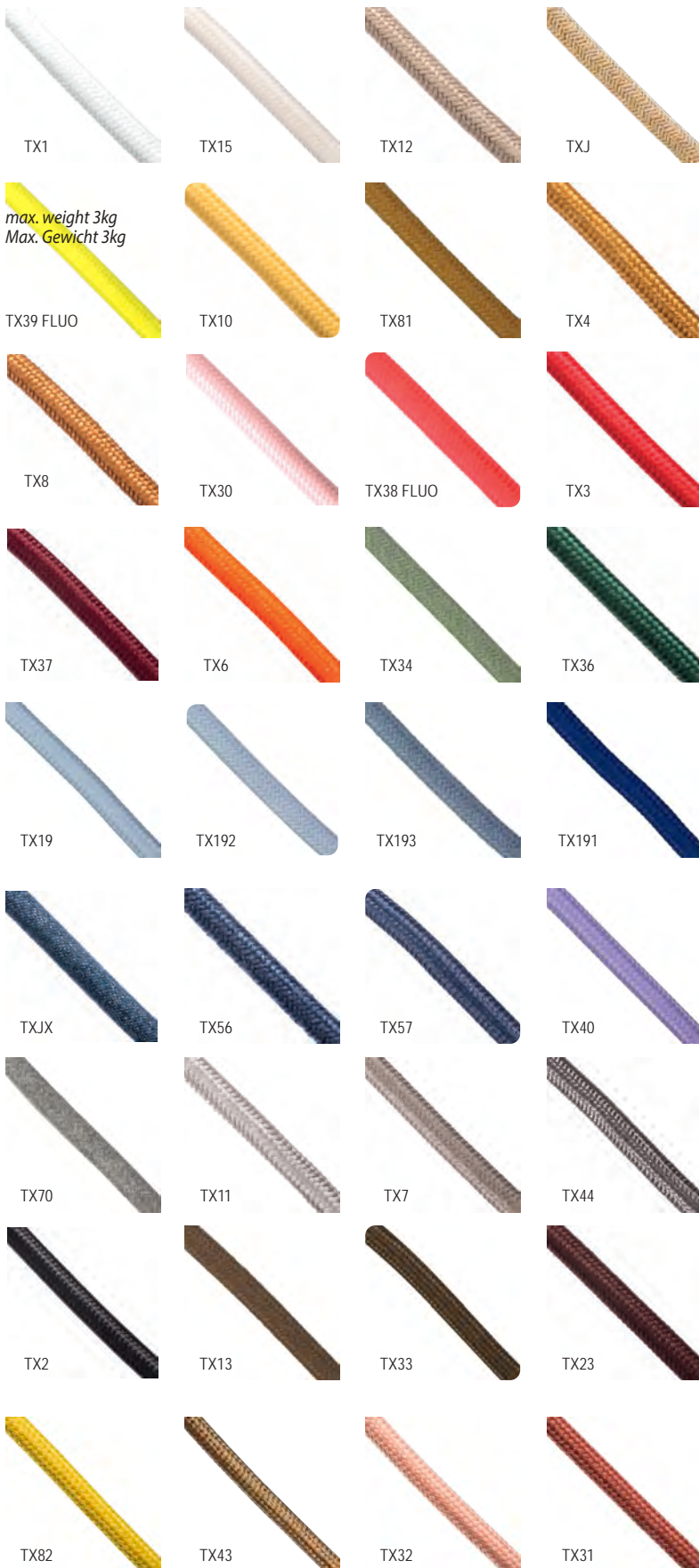

max. weight 3kg  
 Max. Gewicht 3kg

**TXNAT/.. - TEXTILE NATURAL CABLE**

IP20   



textielkabel 3x0,75 /m - max. gewicht 3kg  
 textile cable 3x0,75 /m - max. weight 3kg  
 textielkabel 3x0,75 /m - max. gewicht 3kg  
 textile cable 3x0,75 /m - max. weight 3kg

Ref	
TXNAT.TXM	brass
TXNAT.TXN	nickle
TXNAT.TXRK	red copper
TXNAT.TXRK2	red copper/black
TXNAT.TXS	silver
TXNAT.TXS2	silver

**TXG/.. - TEXTILE GLITTER CABLE**

IP20   



textielkabel 3x0,75 /m - max. gewicht 3kg  
 textile cable 3x0,75 /m - max. weight 3kg  
 textielkabel 3x0,75 /m - max. gewicht 3kg  
 textile cable 3x0,75 /m - max. weight 3kg

Ref	
TXG.TXG4	glitter gold
TXG.TXG7	glitter grey
TXG.TXG13	glitterbronze
TXG.TXG23	glitter brown
TXG.TXG28	glitter copper
TXG.TXG30	glitter pink

**TXSTRIP/.. - TEXTILE STRIPES CABLE**

IP20  

textielkabel 3x0,75 /m - max. gewicht 3kg - textile cable 3x0,75 /m - max. weight 3kg  
 textielkabel 3x0,75 /m - max. gewicht 3kg - textile cable 3x0,75 /m - max. weight 3kg

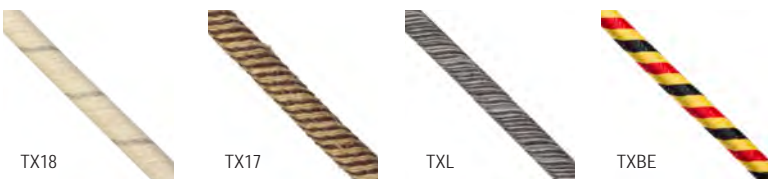

Ref	
TXSTRIP.TX17	jute/cotton
TXSTRIP.TX18	white/grey
TXSTRIP.TXL	linen

**TXPT/.. - TEXTILE PATTERN CABLE**

IP20   

textielkabel 3x0,75 /m - max. gewicht 3kg - textile cable 3x0,75 /m - max. weight 3kg  
 textielkabel 3x0,75 /m - max. gewicht 3kg - textile cable 3x0,75 /m - max. weight 3kg



Ref	
TXPT.TX9	black/white
TXPT.TXP2	black/white pattern
TXPT.TXP3	red/white pattern
TXPT.TXZ2	black/white zigzag
TXPT.TXZ3	red/white zig zag

**TXSTEEL/.. - TEXTILE STEEL CABLE**

IP20  



textile cable 3x0,75/m with steel cable  
Textilkabel 3x0,75/m mit Stahlseil

**Ref**  
TXSTEEL.TX2      black

max. weight 10kg  
max. Gewicht 10kg

**TXTWIST/.. - TEXTILE TWISTED CABLE**

IP20   

textielkabel 3x0,75 /m - max. gewicht 3kg - textile cable 3x0,75 /m - max. weight 3kg  
textielkabel 3x0,75 /m - max. gewicht 3kg - textile cable 3x0,75 /m - max. weight 3kg

**Ref**  
TXTWIST.TXTW1      white  
TXTWIST.TXTW2      black  
TXTWIST.TXTW3      red  
TXTWIST.TXTW4      gold  
TXTWIST.TXTW7      mouse grey  
TXTWIST.TXTW8      whisky  
TXTWIST.TXTW11      alu grey  
TXTWIST.TXTW23      brown  
TXTWIST.TXTW56      jeans  
TXTWIST.TXTWJ      jute





**TEXW\_3X1,5/.. - TEXTILE TWISTED CABLE**

IP20  



TXW1



TXW2

twisted textile cable 3x1,5/m  
verdrilltes Textilkabel 3x1,5/m

**Ref**

TEXW_3X1.5.TXW1	white
TEXW_3X1.5.TXW2	black

Max. weight 3kg  
Max. Gewicht 3kg

**TEXCABLE3X1,5/.. - CABLE**

IP20  



TX1



TX2

textile cable 3x1,5 / m  
Textilkabel 3x1,5 / m

**Ref**

TEXCABLE3X1.5.TX1	white
TEXCABLE3X1.5.TX2	black

Max. weight 3Kg  
Max. Gewicht 3kg

2029/.. - METRO

IP20   0,0600 



accessories for lighting systems - transparant cable per meter  
-current supply 3x0,75  
Zubehör für Lichtsysteme - transparentes Kabel pro Meter -  
Stromzuführung 3x0,75

Ref  
2029

2029A/.. - METRO

IP20   0,0800 



accessories for lighting systems - transparent cable per meter  
- current supply 5x0,75  
Zubehör für Lichtsysteme - transparentes Kabel pro Meter -  
Stromzuführung 5x0,75

Ref  
2029A

2031A/.. - METRO

IP20   0,0800 



accessories for lighting systems - cable per meter - current  
supply 3x0,75  
Zubehör für Lichtsysteme - Kabel per Meter - Stromzuführung  
3x0,75

Ref  
2031A.1  
2031A.2

white  
black

**Materials**  
aluminium

1 | 2



2031B/.. - METRO

IP20   0,5600 



accessories for lighting systems - cable per meter - current  
supply 5x0,75  
Zubehör für Lichtsysteme - Kabel per Meter - Stromzuführung  
5x0,75

Ref  
2031B.1  
2031B.2

white  
black

**Materials**  
aluminium

1 | 2



2031../.. - METRO

IP20   0,9500 



accessories for lighting systems - cable per meter - current supply 3x1  
Zubehör für Lichtsysteme - Kabel pro Meter - Stromzufuhr 3x1

**Materials**  
aluminium

**Ref**

2031.1  
2031.2

white  
black

1 | 2



2020../.. - METRO

IP20   0,0200 



accessories for lighting systems - ceiling base for steel wire  
Zubehör für Lichtsysteme - Deckenbasis für Stahldraht

**Dimensions**  
Ø20xH30

**Materials**  
aluminium

**Ref**

2020.1  
2020.2  
2020.2M  
2020.10

white  
black  
black tex  
alu grey

1 | 2 | 10 | 2M

P041../.. - STAALKABEL

IP20   0,0300 



2,25m steel cable with nipple  
2,25m Stahldraht mit Nippel

**Materials**

**Ref**

P041.2  
P041.11

black  
alu grey

P042../.. - CHAIN - KETTING POLO

IP   0,3500 



supplement - per running meter  
Supplement - pro laufende Meter  
Bar - L1000  
Thread - L45xB20

**Materials**  
INOX 316

**Ref**



P042.2  
P042.5  
P042.5BB  
P042.23

black  
inox 316  
inox 316 2x coated  
dark bronze

5BB



2026/.. - METRO

IP20   0,2300 



accessories for lighting systems - spiral cable 3xG1  
Zubehör für Lichtsysteme - Spiralseil 3xG1

**Dimensions**

←→ L400

**Materials**

aluminium

**Ref**

2026.1

2026.2

2026.11

white

black

alu grey

1 | 2 | 11

40cm not stretched - standard cabling 1 circuit  
40cm nicht ausgedehnt - standard Verkabelung 1  
Stromkreis

S.EXTRACIRCUIT/.. - CIRCUIT

IP20   0,0750 



accessories for lighting systems - cabling extra circuit  
Zubehör für Lichtsysteme - Verkabelung zusätzlicher  
Stromkreis

**Ref**

S.EXTRACIRCUIT

S6.00/.. - PLASTERKIT

IP00    0,1000 

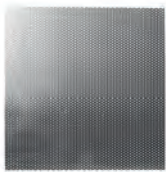

plasterkit - without hole  
Einputzrahmen - ohne ein Loch  
Plasterkit - L250xB250

**Ref**

S6.00

*built-in*

013/.. - ROSETTE - M10



rosette to build in - round  
Einbaurosette - rund

**Dimensions**

↔ Ø33  
↻ Ø30 ↙ ↘ 45

**Materials**

aluminium 1 | 2 | 11 | 14 | 1M | 2M  
brass 4 | 13 | 16  
INOX 316 5

**Ref**

013.1 white  
013.1M white tex  
013.2 black  
013.2M black tex  
013.4 shiny gold  
013.5 inox 316  
013.11 alu grey  
013.13 bronze  
013.14 alu satin  
013.16 satin gold

built-in

014/.. - ROSETTE - M10



rosette to build in - round  
Einbaurosette - rund

**Dimensions**

↔ Ø43  
↻ Ø39-40 ↙ ↘ 45

**Materials**

aluminium 1 | 2 | 11 | 14 | 1M | 2M  
brass 4 | 13 | 16  
INOX 316 5

**Ref**

014.1 white  
014.1M white tex  
014.2 black  
014.2M black tex  
014.4 shiny gold  
014.5 inox 316  
014.11 alu grey  
014.13 bronze  
014.14 alu satin  
014.16 satin gold

built-in

002/.. - ROSETTE - M10



rosette to build in - round  
Einbaurosette - rund

**Dimensions**

↔ Ø50  
↻ Ø35-40 ↙ ↘ 45

**Options**

S2 - FLAT SPRINGS

**Materials**

aluminium 1 | 2 | 11 | 14 | 1M | 2M  
brass 4 | 13 | 16  
INOX 316 5

**Ref**

002.1 white  
002.1M white tex  
002.2 black  
002.2M black tex  
002.4 shiny gold  
002.5 inox 316  
002.11 alu grey  
002.13 bronze  
002.14 alu satin  
002.16 satin gold

built-in

61.10/.. - ROSETTE - M10



rosette to build in - round  
Einbaurosette - rund

**Dimensions**

↔ Ø60  
↻ Ø40 ↙ ↘ 55

**Options**

S2 - FLAT SPRINGS

**Materials**

aluminium 1 | 2 | 11 | 14 | 1M | 2M  
brass 4 | 13 | 16  
INOX 316 5

**Ref**

61.10.1 white  
61.10.1M white tex  
61.10.2 black  
61.10.2M black tex  
61.10.4 shiny gold  
61.10.5 inox 316  
61.10.11 alu grey  
61.10.13 bronze  
61.10.14 alu satin  
61.10.16 satin gold

built-in

81.10/.. - ROSETTE - M10

III S1 IP20    0,1300 



rosette to build in - round  
Einbaurosette - rund

**Dimensions**

 Ø80

 Ø60  55

**Options**

S2 - FLAT SPRINGS

**Materials**

aluminium 1 | 2 | 11 | 14 | 1M | 2M  
brass 4 | 13 | 16 | 23  
INOX 316 5

**Ref**

81.10.1	white
81.10.1M	white tex
81.10.2	black
81.10.2M	black tex
81.10.4	shiny gold
81.10.5	inox 316
81.10.11	alu grey
81.10.13	bronze
81.10.14	alu satin
81.10.16	satin gold
81.10.23	dark bronze

built-in

101.10/.. - ROSETTE - M10



III S1 IP20    0,1850 



rosette to build in - round  
Einbaurosette - rund

**Dimensions**

 Ø100

 Ø80  55

**Options**

S2 - FLAT SPRINGS

**Materials**

aluminium 1 | 2 | 11 | 14 | 1M | 2M  
brass 4 | 13 | 16

**Ref**

101.10.1	white
101.10.1M	white tex
101.10.2	black
101.10.2M	black tex
101.10.4	shiny gold
101.10.11	alu grey
101.10.13	bronze
101.10.14	alu satin
101.10.16	satin gold

built-in

121.10/.. - ROSETTE - M10



III S1 IP20    0,2500 



rosette to build in - round  
Einbaurosette - rund

**Dimensions**

 Ø120

 Ø100  55

**Options**

S2 - FLAT SPRINGS

**Materials**

aluminium 1 | 2 | 11 | 14 | 1M | 2M  
brass 4 | 13 | 16

**Ref**

121.10.1	white
121.10.1M	white tex
121.10.2	black
121.10.2M	black tex
121.10.4	shiny gold
121.10.11	alu grey
121.10.13	bronze
121.10.14	alu satin
121.10.16	satin gold

built-in

141.10/.. - ROSETTE - M10

III S1 IP20    0,3500 



rosette to build in - round  
Einbaurosette - rund

**Dimensions**

 Ø140

 Ø120  55

**Options**

S2 - FLAT SPRINGS

**Materials**

aluminium 1 | 2 | 11 | 14 | 1M | 2M  
brass 4 | 13 | 16

**Ref**

141.10.1	white
141.10.1M	white tex
141.10.2	black
141.10.2M	black tex
141.10.4	shiny gold
141.10.11	alu grey
141.10.13	bronze
141.10.14	alu satin
141.10.16	satin gold

built-in



161.10/.. - ROSETTE - M10



rosette to build in - round  
Einbaurosette - rund

**Dimensions**

↔ Ø160

↻ Ø140 ↘ 55

**Options**

S2 - FLAT SPRINGS

**Materials**

aluminium

1 | 2 | 11 | 14 | 1M | 2M

brass

4 | 13 | 16

**Ref**

161.10.1	white
161.10.1M	white tex
161.10.2	black
161.10.2M	black tex
161.10.4	shiny gold
161.10.11	alu grey
161.10.13	bronze
161.10.14	alu satin
161.10.16	satin gold

built-in

181.10/.. - ROSETTE - M10

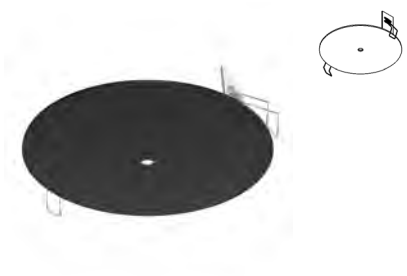

rosette to build in - round  
Einbaurosette - rund

**Dimensions**

↔ Ø180

↻ Ø160 ↘ 55

**Options**

S2 - FLAT SPRINGS

**Materials**

aluminium

1 | 2 | 11 | 14 | 1M | 2M

brass

4 | 13 | 16

**Ref**

181.10.1	white
181.10.1M	white tex
181.10.2	black
181.10.2M	black tex
181.10.4	shiny gold
181.10.11	alu grey
181.10.13	bronze
181.10.14	alu satin
181.10.16	satin gold

built-in



102.10/.. - ROSETTE - M10

III S1 IP20    0,1850 



rosette to build in - round  
Einbaurosette - rund

**Dimensions**

 Ø100

 Ø80  55

**Options**

S2 - FLAT SPRINGS

**Materials**

aluminium 1 | 2 | 11 | 14 | 1M | 2M  
brass 4 | 13 | 16

**Ref**

102.10.1	white
102.10.1M	white tex
102.10.2	black
102.10.2M	black tex
102.10.4	shiny gold
102.10.11	alu grey
102.10.13	bronze
102.10.14	alu satin
102.10.16	satin gold

built-in

122.10/.. - ROSETTE - M10



III S1 IP20    0,2500 



rosette to build in - round  
Einbaurosette - rund

**Dimensions**

 Ø120

 Ø100  55

**Options**

S2 - FLAT SPRINGS

**Materials**

aluminium 1 | 2 | 11 | 14 | 1M | 2M  
brass 4 | 13 | 16

**Ref**

122.10.1	white
122.10.1M	white tex
122.10.2	black
122.10.2M	black tex
122.10.4	shiny gold
122.10.11	alu grey
122.10.13	bronze
122.10.14	alu satin
122.10.16	satin gold

built-in

142.10/.. - ROSETTE - M10



III S1 IP20    0,3500 



rosette to build in - round  
Einbaurosette - rund

**Dimensions**

 Ø140

 Ø120  55

**Options**

S2 - FLAT SPRINGS

**Materials**

aluminium 1 | 2 | 11 | 14 | 1M | 2M  
brass 4 | 13 | 16

**Ref**

142.10.1	white
142.10.1M	white tex
142.10.2	black
142.10.2M	black tex
142.10.4	shiny gold
142.10.11	alu grey
142.10.13	bronze
142.10.14	alu satin
142.10.16	satin gold

built-in

162.10/.. - ROSETTE - M10



III S1 IP20    0,4150 



rosette to build in - round  
Einbaurosette - rund

**Dimensions**

 Ø160

 Ø140  55

**Options**

S2 - FLAT SPRINGS

**Materials**

aluminium 1 | 2 | 11 | 14 | 1M | 2M  
brass 4 | 13 | 16

**Ref**

162.10.1	white
162.10.1M	white tex
162.10.2	black
162.10.2M	black tex
162.10.4	shiny gold
162.10.11	alu grey
162.10.13	bronze
162.10.14	alu satin
162.10.16	satin gold

built-in

182.10/.. - ROSETTE - M10

III S1 IP20    0.5050 



rosette to build in - round  
Einbaurosette - rund

**Dimensions**

→ Ø180

⊘ Ø160 ∟ 55

**Options**

S2 - FLAT SPRINGS

**Materials**

aluminium

brass

1 | 2 | 11 | 14 | 1M | 2M  
4 | 13 | 16

**Ref**

182.10.1	white
182.10.1M	white tex
182.10.2	black
182.10.2M	black tex
182.10.4	shiny gold
182.10.11	alu grey
182.10.13	bronze
182.10.14	alu satin
182.10.16	satin gold

built-in

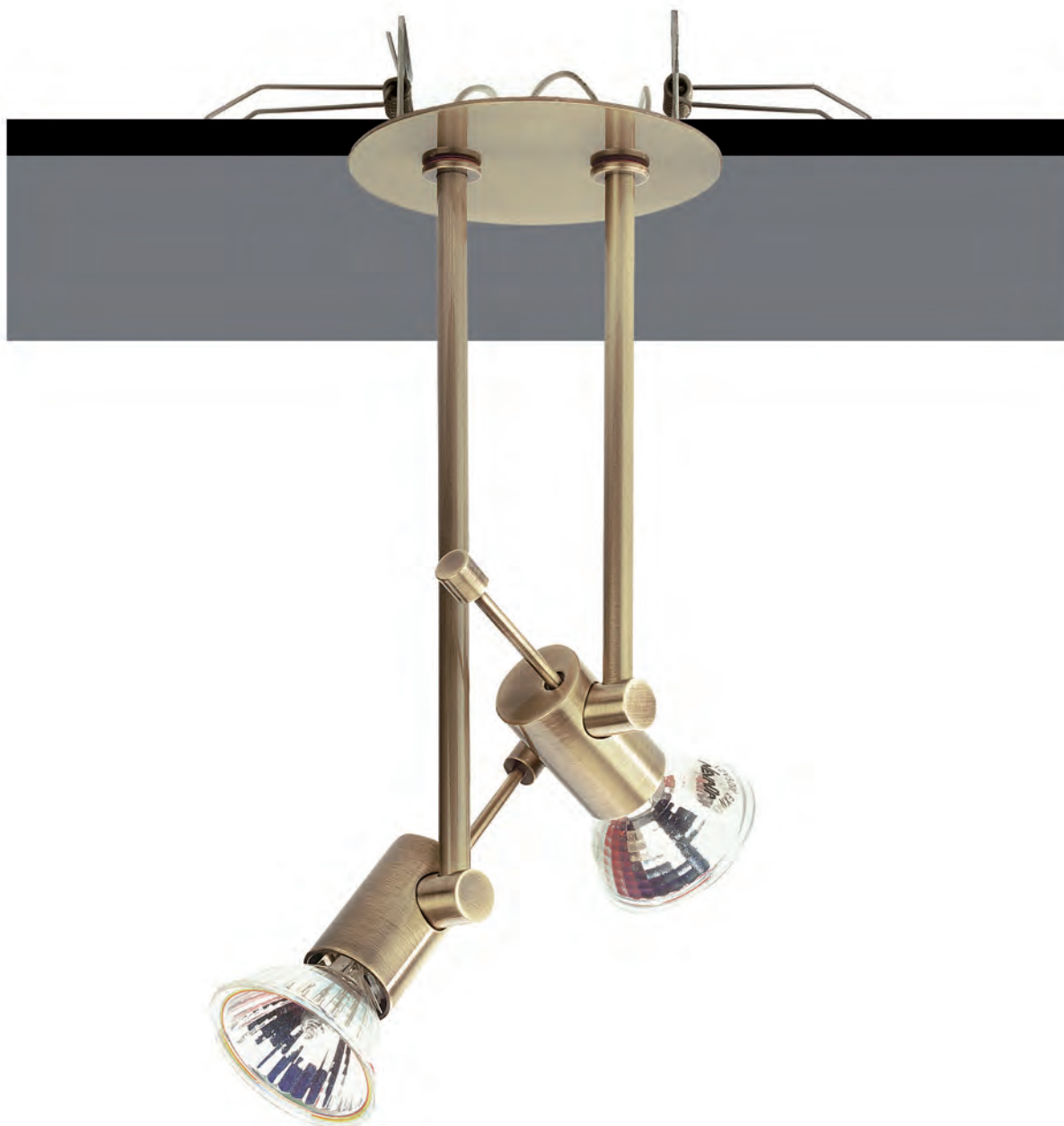





065/./.. - ROSETTE M6-M8-M10-D8,3 - B3

II S1 IP20   



rosette to build in - round - with swivel B3  
Einbaurosette - rund - mit Kugelgelenk B3

**Dimensions**

 Ø65  
 Ø42-45  55



**Materials**

aluminium 1 | 2 | 11 | 14 | 1M | 2M  
brass 4 | 13 | 16

Colour	065.D8,3/..	065.M10/..	065.M6/..	065.M8/..
	Ø	Ø	Ø	Ø
1				
1M				
2				
2M				
4				
11				
13				
14				
16				

**built-in**  
for pendants only - not for spots  
nur für Hängeleuchte - nicht für Aufbaustrahler



080/./.. - ROSETTE M6-M8-M10-D8,3 - B3

II S1 IP20   



rosette to build in - round - with swivel B3  
Einbaurosette - rund - mit Kugelgelenk B3

**Dimensions**

 Ø80  
 Ø42-60  55



**Materials**

aluminium 1 | 2 | 11 | 14 | 1M | 2M  
brass 4 | 13 | 16

Colour	080.D8,3/..	080.M10/..	080.M6/..	080.M8/..
	Ø	Ø	Ø	Ø
1				
1M				
2				
2M				
4				
11				
13				
14				
16				

**built-in**  
for pendants only - not for spots  
nur für Hängeleuchte - nicht für Aufbaustrahler

100/./.. - ROSETTE M6-M8-M10-D8,3 - B3



III S1 IP20   CE



rosette to build in - round - with swivel B3  
Einbaurosette - rund - mit Kugelgelenk B3

Dimensions

 Ø100

 Ø80  55

Materials  
aluminium

1 | 2 | 11 | 14 | 1M | 2M

Colour	100.D8,3/..	100.M10/..	100.M6/..	100.M8/..
	Ø	Ø	Ø	Ø
1				
1M				
2				
2M				
11				
14				

**built-in**  
for pendants only - not for spots  
nur für Hängeleuchte - nicht für Aufbaustrahler



1428/.. - ROSETTE IN WITH SCREWS - M10

III IP20   CE



rosette to build in - round  
Einbaurosette - rund

Dimensions

 Ø90

 67-68

Materials

aluminium

Ref

1428.1M

white tex

1428.2M

black tex

1M | 2M

**built-in**

mount to gyproc box with 2 screws  
mit 2 Schrauben an der Einbauschachtel für  
Gipsplatten befestigen

1429/.. - ROSETTE IN WITH SCREWS - M10

III IP20   CE



rosette to build in - square  
Einbaurosette - viereckig

Dimensions

 L80xB80

 67-68

Materials

aluminium

Ref

1429.1M

white tex

1429.2M

black tex

1M | 2M

**built-in**

mount to gyproc box with 2 screws  
mit 2 Schrauben an der Einbauschachtel für  
Gipsplatten befestigen





40.10/.. - ROSETTE - M10



rosette to build in - square  
Einbaurosette - viereckig

**Dimensions**

↔ L40xB40

📏 Ø30 ⚙️ 55

**Materials**

aluminium	1	2	11	14	1M	2M
brass					4	13   16
INOX 316						5

**Ref**

40.10.1	white
40.10.1M	white tex
40.10.2	black
40.10.2M	black tex
40.10.4	shiny gold
40.10.5	inox 316
40.10.11	alu grey
40.10.13	bronze
40.10.14	alu satin
40.10.16	satin gold

built-in

50.10/.. - ROSETTE - M10



rosette to build in - square  
Einbaurosette - viereckig

**Dimensions**

↔ L50xB50

📏 Ø30 ⚙️ 55

**Materials**

aluminium	1	2	11	14	1M	2M
brass					4	13   16

**Ref**

50.10.1	white
50.10.1M	white tex
50.10.2	black
50.10.2M	black tex
50.10.4	shiny gold
50.10.11	alu grey
50.10.13	bronze
50.10.14	alu satin
50.10.16	satin gold

built-in

60.10/.. - ROSETTE - M10



rosette to build in - square  
Einbaurosette - viereckig

**Dimensions**

↔ L60xB60

📏 Ø39-40 ⚙️ 55

**Options**

S2 - FLAT SPRINGS

**Materials**

aluminium	1	2	11	14	1M	2M
brass					4	13   16
INOX 316						5

**Ref**

60.10.1	white
60.10.1M	white tex
60.10.2	black
60.10.2M	black tex
60.10.4	shiny gold
60.10.5	inox 316
60.10.11	alu grey
60.10.13	bronze
60.10.14	alu satin
60.10.16	satin gold

built-in

80.10/.. - ROSETTE - M10



rosette to build in - square  
Einbaurosette - viereckig

**Dimensions**

↔ L80xB80

📏 Ø60 ⚙️ 55

**Options**

S2 - FLAT SPRINGS

**Materials**

aluminium	1	2	11	14	1M	2M
brass					4	13   16
INOX 316						5

**Ref**

80.10.1	white
80.10.1M	white tex
80.10.2	black
80.10.2M	black tex
80.10.4	shiny gold
80.10.5	inox 316
80.10.11	alu grey
80.10.13	bronze
80.10.14	alu satin
80.10.16	satin gold

built-in

100.10/.. - ROSETTE - M10

III S1 IP20    0.2080 



built-in



rosette to build in - square  
Einbaurosette - viereckig

**Dimensions**

L100xB100

Ø80 L 55

**Options**

S2 - FLAT SPRINGS

**Materials**

aluminium	1   2   11   14   1M   2M
brass	4   13   16
INOX 316	5

**Ref**

100.10.1	white
100.10.1M	white tex
100.10.2	black
100.10.2M	black tex
100.10.4	shiny gold
100.10.5	inox 316
100.10.11	alu grey
100.10.13	bronze
100.10.14	alu satin
100.10.16	satin gold

065.65/./.. - ROSETTE M6-M8-M10-D8,3 - B3



II S1 IP20   CE



rosette to build in - square - with swivel B3  
Einbaurosette - viereckig - mit Kugelgelenk B3

Dimensions

 L65x65

 Ø42-45  55

Materials

aluminium  
brass

1 | 2 | 11 | 14 | 1M | 2M  
4 | 13 | 16

Colour	065.65. D8,3/..	065.65. M10/..	065.65. M6/..	065.65. M8/..
	Ø	Ø	Ø	Ø
1				
1M				
2				
2M				
4				
11				
13				
14				
16				

**built-in**  
for pendants only - not for spots  
nur für Hängeleuchte - nicht für Aufbaustrahler

080.80/./.. - ROSETTE M6-M8-M10-D8,3 - B3



II S1 IP20   CE



rosette to build in - square - with swivel B3  
Einbaurosette - viereckig - mit Kugelgelenk B3

Dimensions

 L80x80

 Ø42-60  55

Materials

aluminium  
brass

1 | 2 | 11 | 14 | 1M | 2M  
4 | 13 | 16

Colour	080.80. D8,3/..	080.80. M10/..	080.80. M6/..	080.80. M8/..
	Ø	Ø	Ø	Ø
1				
1M				
2				
2M				
4				
11				
13				
14				
16				

**built-in**  
for pendants only - not for spots  
nur für Hängeleuchte - nicht für Aufbaustrahler



100.100/././.. - ROSETTE - B3

III S1 IP20   





rosette to build in - square - with swivel B3  
Einbaurosette - viereckig - mit Kugelgelenk B3

**Materials**  
aluminium

1 | 2 | 11 | 14 | 1M | 2M

**Dimensions**

 L100xB100

 Ø80  55

Colour	100.100. D8,3/..	100.100. M10/..	100.100. M6/..	100.100. M8/..
	Ø	Ø	Ø	Ø
1				
1M				
2				
2M				
11				
14				

**built-in**  
for pendants only - not for spots  
nur für Hängeleuchte - nicht für Aufbaustrahler

**P039/.. - STRAIN RELIEF - TREKONTLASTING**

IP20    



strain relief  
Zugentlastung

**Dimensions**

↔ Ø15xH21

**Materials**

aluminium	1	2	11	14	1M	21	2M	44	46	53
brass							4	13	16	23
red copper										28

**Ref**

P039.1	white
P039.1M	white tex
P039.2	black
P039.2M	black tex
P039.4	shiny gold
P039.11	alu grey
P039.13	bronze
P039.14	alu satin
P039.16	satin gold
P039.21	rust
P039.23	dark bronze
P039.28	rosé
P039.44	anthracite grey
P039.46	grey-brown
P039.53	bronze-brown

to be fixed to rosette or ceiling light  
für Montage auf Rosette oder Deckenleuchte

**000CR/.. - TREKONTLASTING PER PENDEL TEXTILE**

IP20    

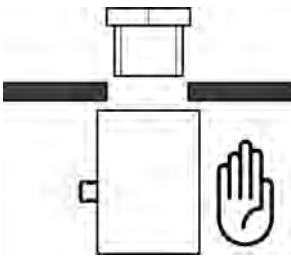

drawing holes + drilling + strain relief  
Zeichnen Locher + Bohrung + Zugentlastung

**Dimensions**

↔ Ø15xH21

**Materials**

aluminium	1	2	11	14	1M	21	2M	44	46	53
brass							4	13	16	23

**Ref**

000CR.1	white
000CR.1M	white tex
000CR.2	black
000CR.2M	black tex
000CR.4	shiny gold
000CR.11	alu grey
000CR.13	bronze
000CR.14	alu satin
000CR.16	satin gold
000CR.21	rust
000CR.23	dark bronze
000CR.44	anthracite grey
000CR.46	grey-brown
000CR.53	bronze-brown

built-up

**P040/.. - STRAIN RELIEF - TREKONTLASTING**

IP20    



strain relief  
Zugentlastung

**Dimensions**  
↔ Ø15xH21

**Materials**

aluminium	1	2	11	14	1M	2M
brass			4	13	16	23
red copper						28

**Ref**

P040.1	white
P040.1M	white tex
P040.2	black
P040.2M	black tex
P040.4	shiny gold
P040.11	alu grey
P040.13	bronze
P040.14	alu satin
P040.16	satin gold
P040.23	dark bronze
P040.28	rosé

to be fixed to rosette or ceiling light  
für Montage auf Rosette oder Deckenleuchte

**000C/.. - TREKONTLASTING PER PENDEL TEXTILE**

IP20    

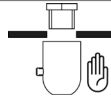
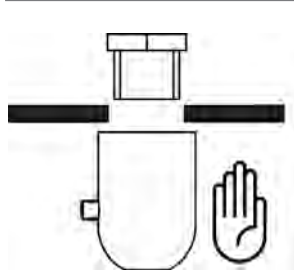

drawing holes + drilling + strain relief  
Zeichnen Locher + Bohrung + Zugentlastung

**Dimensions**  
↔ Ø15xH21

**Materials**

aluminium	11	14	1M	21	2M	46	53	
brass						13	16	23

**Ref**

000C.1M	white tex
000C.2M	black tex
000C.11	alu grey
000C.13	bronze
000C.14	alu satin
000C.16	satin gold
000C.21	rust
000C.23	dark bronze
000C.46	grey-brown
000C.53	bronze-brown

built-up





5014/.. - MAESTRO

IP20    



connector for wall or ceiling cord attachment for iron cord  
Wand- und Deckenkabelhalter für Kabel

**Dimensions**  
↔ Ø20xH14

**Materials**  
aluminium 1M | 2M  
brass 13 | 16 | 23

Ref	
5014.1M	white tex
5014.2M	black tex
5014.13	bronze
5014.16	satin gold
5014.23	dark bronze

built-up

1069/.. - CONNECTOR

IP20    



cable conduit support for suspension lights  
Kabelhalter für Hängelampen





**Dimensions**  
↔ Ø20xH30

**Materials**  
aluminium 1M | 2M | 46 | 53

Ref	
1069.1M	white tex
1069.2M	black tex
1069.46	grey-brown
1069.53	bronze-brown

built-up

056/.. - DECENTRALISATIESTEUN

IP20    



cable conduit support for suspension lights  
Kabelhalter für Hängelampen

**Dimensions**  
↔ Ø19xH38

**Materials**  
aluminium 14 | 1M | 2M  
brass 13 | 16 | 23

Ref	
056.1M	white tex
056.2M	black tex
056.13	bronze
056.14	alu satin
056.16	satin gold
056.23	dark bronze

built-up  
for textile kabel 3x0,75  
für Textilkabel 3x0,75

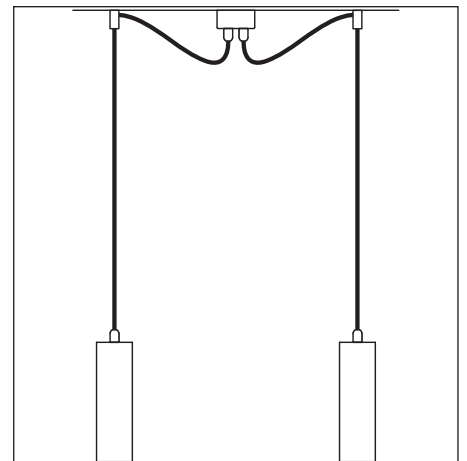
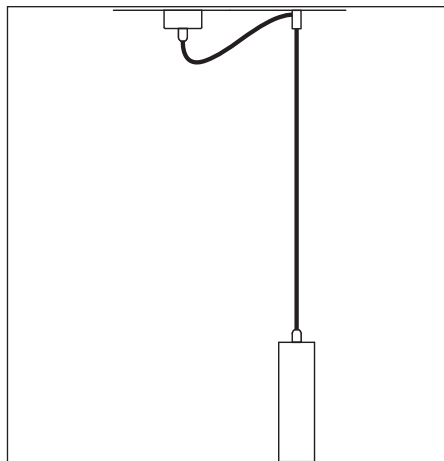
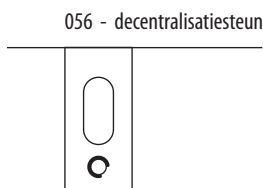

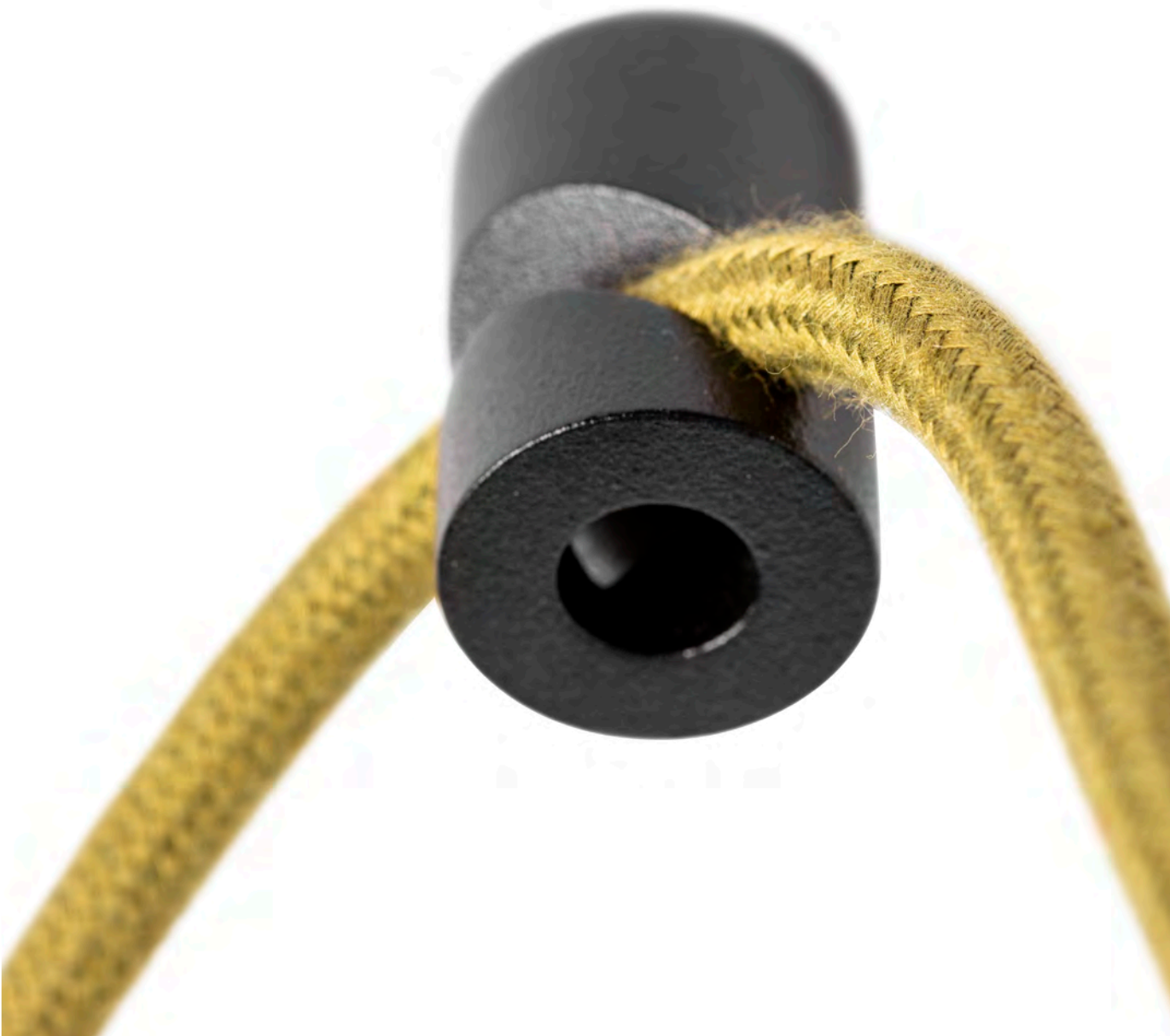

015/./.. - KNEEJOINT - M6 -M8 -M10

IP00   



accessories for built-up spot - directional - 12V  
Zubehör für Aufbaustrahler - schwenkbar - 12V

**Materials**  
aluminium  
brass

1 | 2 | 11 | 1M | 2M  
4 | 13 | 16

Colour	015.M10/..	015.M6/..	015.M8/..
	Ø	Ø	Ø
1			
1M			
2			
2M			
4			
11			
13			
16			

built-up  
12V only  
nur 12V

019/.. - KNEEJOINT

IP00    0,0400 



accessories for built-up spot - directional - M10 - M8x0,75 + stop 12V-230V  
Zubehör für Aufbaustrahler - schwenkbar - M10 - M8x0,75 + Stopp 12V-230V  
Kneejoint - Ø17xH37

**Materials**  
aluminium 14 | 1M | 2M  
brass 4 | 13 | 16 | 23

**Ref**  
019.1M white tex  
019.2M black tex  
019.4 shiny gold  
019.13 bronze  
019.14 alu satin  
019.16 satin gold  
019.23 dark bronze

built-up  
12V-230V

022/.. - KNEEJOINT

IP00    0,0200 



accessories for built-up spot - directional - 230V  
Zubehör für Aufbaustrahler - schwenkbar - 230V

**Materials**  
aluminium 1 | 2 | 11 | 1M | 2M  
brass 4 | 13 | 16

**Ref**  
022.1 white  
022.1M white tex  
022.2 black  
022.2M black tex  
022.4 shiny gold  
022.11 alu grey  
022.13 bronze  
022.16 satin gold

built-up  
12V-230V

023.M6/.. - CONNECTOR FOR TRACKS - M6x1

IP20    



accessories for built-up spot or pendant - M10 - M6x1 (12V)  
Zubehör für Aufbauleuchte oder Pendelleuchte - M10 - M6x1 (12V)

**Materials**

aluminium	1	2	11	14
brass	4	13	16	

**Ref**

023.M6.1	white
023.M6.2	black
023.M6.4	shiny gold
023.M6.11	alu grey
023.M6.13	bronze
023.M6.14	alu satin
023.M6.16	satin gold

023.M10/.. - CONNECTOR FOR TRACKS - M8x1

IP20    



accessories for built-up spot or pendant - M10 - M8x0,75 (12V)  
Zubehör für Aufbauleuchte oder Pendelleuchte - M10 - M8x0,75 (12V)

**Materials**

aluminium	1	2	11	14
brass	4	13	16	

**Ref**

023.M10.1	white
023.M10.2	black
023.M10.4	shiny gold
023.M10.11	alu grey
023.M10.13	bronze
023.M10.14	alu satin
023.M10.16	satin gold

024/.. - CONNECTOR FOR TRACKS

IP20    



accessories for built-up spot or pendant - for monorail M10x1 - M8x0,75 (12V-230V)  
Zubehör für Aufbauleuchte oder Pendelleuchte - für Monorail M10x1 - M8x0,75 (12V-230V)

**Materials**

aluminium	1	2	11	14	1M	2M
brass	4	13	16			

**Ref**

024.1	white
024.1M	white tex
024.2	black
024.2M	black tex
024.4	shiny gold
024.11	alu grey
024.13	bronze
024.14	alu satin
024.16	satin gold

built-up





1433/.. - ROSETTE UP - TX

~230V



IP20



round  
rund

**Dimensions**  
Ø65xH35

**Materials**

aluminium

14 | 1M | 29 | 2M

**Ref**

1433.1M

1433.2M

1433.2M.14

1433.2M.16

1433.2M.28

1433.14

1433.14.2M

1433.29

white tex

black tex

black tex

black tex

black tex

alu satin

alu satin

black - gold inside

built-up

1434/.. - ROSETTE UP - TX

~230V



IP20



05.20.02

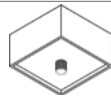

square  
viereckig

**Materials**

aluminium

14 | 1M | 29 | 2M

**Ref**

1434.1M

1434.2M

1434.2M.14

1434.2M.16

1434.2M.28

1434.14

1434.14.2M

1434.29

white tex

black tex

black tex

black tex

black tex

alu satin

alu satin

black - gold inside

built-up



054B/.. - ROSETTE for textile cable - TX

~230V  IP20    0,1200 



built-up base - built-up base with strain relief for 1 textile cable  
 Aufbaurosette - Aufbaurosette mit Zugentlastung für 1 Textilkabel





**Dimensions**  
 $\longleftrightarrow$  Ø64xH41

Materials	14	1M	2M
aluminium			
brass	4	13	16
red copper			28

Ref	
054B.1M	white tex
054B.2M	black tex
054B.4	shiny gold
054B.13	bronze
054B.14	alu satin
054B.16	satin gold
054B.23	dark bronze
054B.28	rosé

built-up

055B/.. - ROSETTE for textile cable - TX

~230V  IP20    0,2000 



built-up base - with strain relief for 1 textile cable  
 Aufbaurosette - mit Zugentlastung für 1 Textilkabel

**Dimensions**  
 $\longleftrightarrow$  Ø62xH30

Materials	14	1M	2M
aluminium			
brass	4	13	16
red copper			28

Ref	
055B.1M	white tex
055B.2M	black tex
055B.4	shiny gold
055B.13	bronze
055B.14	alu satin
055B.16	satin gold
055B.23	dark bronze
055B.28	rosé

built-up

057/.. - ROSETTE for textile cable - TX

~230V  IP20    0,1300 



built-up base - built-up base with strain relief for 1 textile cable + 2,25m steel cable  
 Aufbaurosette - Aufbaurosette mit Zugentlastung für 1 Textilkabel + 2,25 Meter Stahldraht

**Dimensions**  
 $\longleftrightarrow$  Ø62xH30

Materials	14	1M	2M
aluminium			
brass		13	16
red copper			28

Ref	
057.1M	white tex
057.2M	black tex
057.13	bronze
057.14	alu satin
057.16	satin gold
057.23	dark bronze
057.28	rosé

built-up  
 the workload is 4 - 15 kg  
 die Arbeitslast beträgt 4 ñ 15 kg.

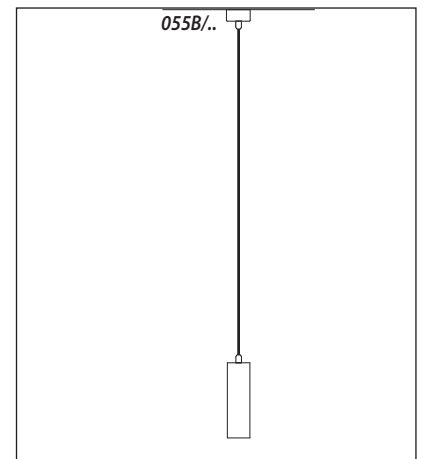
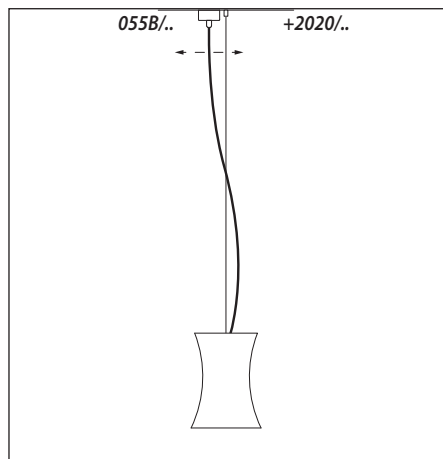
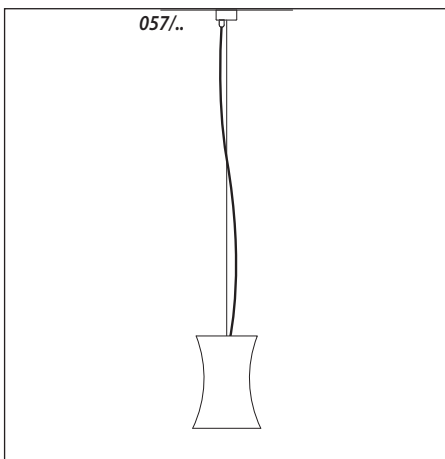

058/.. - ROSETTE for textile cable - TX

~230V  IP20    0,1600 



built-up base - built-up base with strain relief for 1 textile cable + 2,25m steel cable with height controller  
 Aufbaurosette - Aufbaurosette mit Zugentlastung für 1 Textilkabel + 2,25 Meter Stahldraht mit Höheregler

**Dimensions**

↔ Ø62xH30

**Materials**

aluminium 14 | 1M | 2M  
 brass 13 | 16

**Ref**

058.1M white tex  
 058.2M black tex  
 058.13 bronze  
 058.14 alu satin  
 058.16 satin gold

**built-up**  
 according to rope diameter, the workload is 4 - 15 kg  
 nach Seildurchmesser Ø1,25 beträgt die Arbeitslast 4 ñ 15 kg

058.2/.. - ROSETTE for textile cable - TX

~230V  IP20    0,1600 



built-up base - built-up base with strain reliefs for 2 textile cables + hole for steel cable  
 Aufbaurosette - Aufbaurosette mit Zugentlastung für 2 Textilkabels + Loch für Stahldraht

**Dimensions**

↔ Ø62xH30

**Options**

P041 - STAALKABEL

**Materials**



aluminium 14 | 1M | 2M  
 brass 13 | 16

**Ref**

058.2.1M white tex  
 058.2.2M black tex  
 058.2.13 bronze  
 058.2.14 alu satin  
 058.2.16 satin gold

**built-up**  
 steel cable not included  
 Stahldraht nicht einbegriffen

058.3/.. - ROSETTE for textile cable - TX

~230V  IP20    0,2000 



built-up base - built-up base with strain reliefs for 3 textile cables + hole for steel cable  
 Aufbaurosette - Aufbaurosette mit Zugentlastung für 3 Textilkabels + Loch für Stahldraht

**Dimensions**

↔ Ø62xH30

**Options**

P041 - STAALKABEL

**Materials**

aluminium 14 | 1M | 2M  
 brass 13 | 16

**Ref**

058.3.1M white tex  
 058.3.2M black tex  
 058.3.13 bronze  
 058.3.14 alu satin  
 058.3.16 satin gold

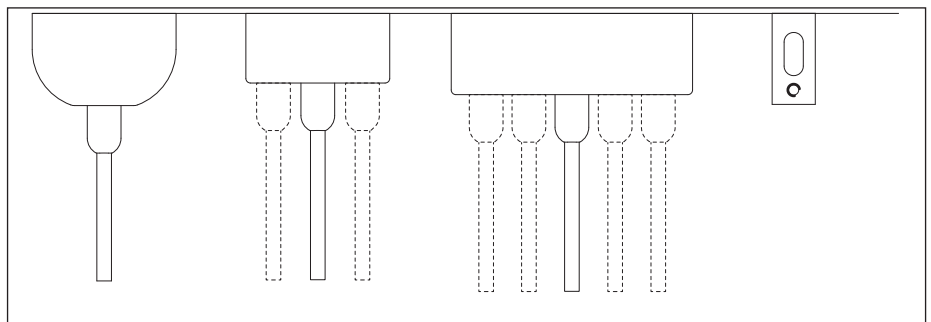

**built-up**  
 steel cable not included  
 Stahldraht nicht einbegriffen

054B/.. 1 pendel  
 055B/.. - 1 pendel  
 058.2/.. - 2 pendels  
 058.3/.. - 3 pendels  
 059.1/.. - 1 pendel  
 059.4/.. - 4 pendels  
 058.5/.. - 5 pendels  
 058.6/.. - 6 pendels  
 058.7/.. - 7 pendels  
 056/.. decentralisatiesteun





059.1/.. - ROSETTE for textile cable - TX

~230V  IP20    0,3500 



built-up base - built-up base with strain relief for 1 textile cable  
 Aufbaurosette - Aufbaurosette mit Zugentlastung für 1 Textilkabel

**Dimensions**

↔ Ø104xH34

**Materials**





aluminium 14 | 1M | 2M  
 brass 13 | 16

**Ref**

059.1.1M	white tex
059.1.2M	black tex
059.1.13	bronze
059.1.14	alu satin
059.1.16	satin gold

built-up

059.4/.. - ROSETTE for textile cable - TX

~230V  IP20    0,3500 



built-up base - built-up base with strain reliefs for 4 textile cables  
 Aufbaurosette - Aufbaurosette mit Zugentlastung für 4 Textilkabels

**Dimensions**

↔ Ø104xH34

**Materials**

aluminium 14 | 1M | 2M  
 brass 13 | 16

**Ref**

059.4.1M	white tex
059.4.2M	black tex
059.4.13	bronze
059.4.14	alu satin
059.4.16	satin gold

built-up

059.5/.. - ROSETTE for textile cable - TX

~230V  IP20    0,4300 



built-up base - built-up base with strain reliefs for 5 textile cables  
 Aufbaurosette - Aufbaurosette mit Zugentlastung für 5 Textilkabels

**Dimensions**

↔ Ø104xH34

**Materials**





aluminium 14 | 1M | 2M  
 brass 13 | 16

**Ref**

059.5.1M	white tex
059.5.2M	black tex
059.5.13	bronze
059.5.14	alu satin
059.5.16	satin gold

built-up

059.6/.. - ROSETTE for textile cable - TX

~230V  IP20    0,4300 



built-up base - built-up base with strain reliefs for 6 textile cables  
 Aufbaurosette - Aufbaurosette mit Zugentlastung für 6 Textilkabels

**Dimensions**

↔ Ø104xH34

**Materials**

aluminium 14 | 1M | 2M  
 brass 13 | 16

**Ref**

059.6.1M	white tex
059.6.2M	black tex
059.6.13	bronze
059.6.14	alu satin
059.6.16	satin gold

built-up

059.7/.. - ROSETTE for textile cable - TX

~230V



IP20



built-up base - built-up base with strain reliefs for 7 textile cables  
 Aufbaurosette - Aufbaurosette mit Zugentlastung für 7 Textilkabels

**Dimensions**

Ø104xH34

**Materials**

aluminium 14 | 1M | 2M  
 brass 13 | 16

**Ref**

059.7.1M	white tex
059.7.2M	black tex
059.7.13	bronze
059.7.14	alu satin
059.7.16	satin gold

built-up

058.5/.. - 5 pendels

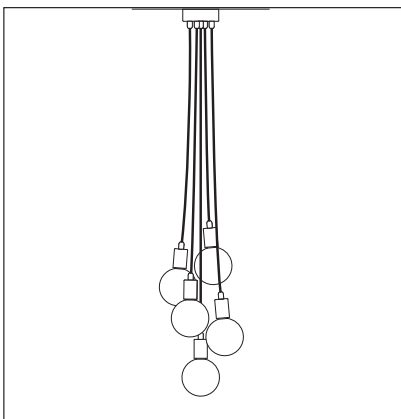

055B/..

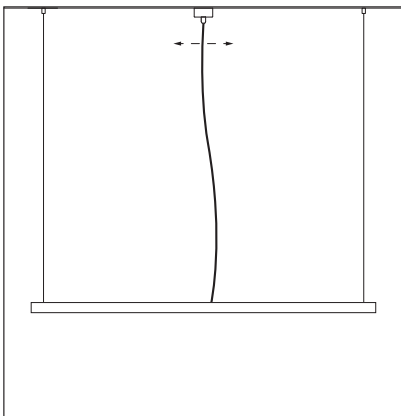

055B/.. - 1 pendel 056/.. decentralisatiesteun

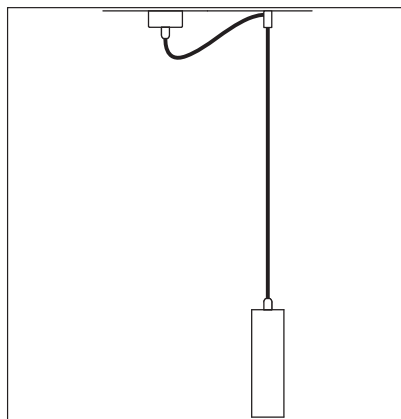

058/..

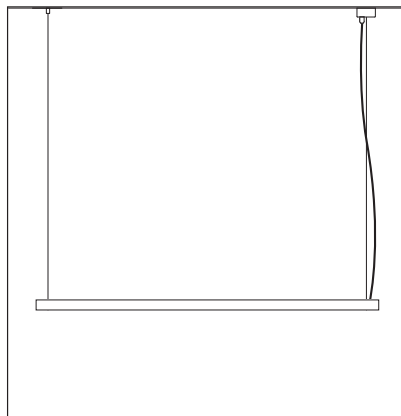

058.2/.. - 2 pendels 2x056/.. decentralisatiesteun

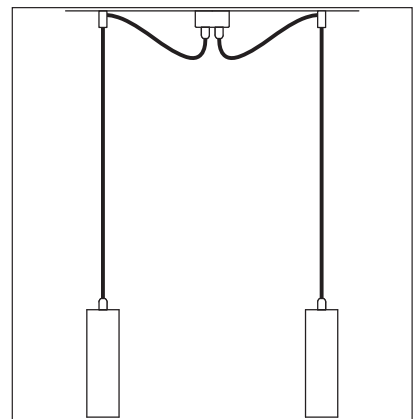

058.2/..

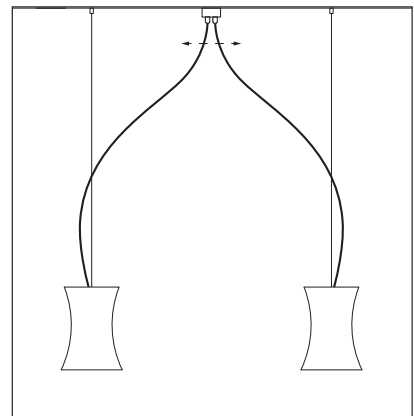

071../.. - ROSETTE for textile cable - TX

~230V  IP20    0.2100 



built-up base - with strain relief for 1 textile cable  
 Aufbaurosette - mit Zugentlastung für 1 Textilkabel

**Dimensions**

↔ Ø82xH32

**Materials**

aluminium 14 | 1M | 2M  
 brass 13 | 16

**Ref**

071.1M white tex  
 071.2M black tex  
 071.13 bronze  
 071.14 alu satin  
 071.16 satin gold

built-up

072../.. - ROSETTE for textile cable - TX

~230V  IP20   



built-up base - built-up base with strain relief for 1 textile cable + 2,25m steel cable  
 Aufbaurosette - Aufbaurosette mit Zugentlastung für 1 Textilkabel + 2,25 Meter Stahldraht

**Dimensions**

↔ Ø82xH32

**Materials**

aluminium 14 | 1M | 2M  
 brass 13 | 16



**Ref**

072.1M white tex  
 072.2M black tex  
 072.13 bronze  
 072.14 alu satin  
 072.16 satin gold

built-up

according to rope diameter, the workload is 4 - 15 kg  
 nach Seildurchmesser Ø1,25 beträgt die Arbeitslast 4 ñ 15 kg

073../.. - ROSETTE FOR TEXTILE CABLE - TX

~230V  IP20   



built-up base - built-up base with strain relief for 1 textile cable + 2,25m steel cable with height controller  
 Aufbaurosette - Aufbaurosette mit Zugentlastung für 1 Textilkabel + 2,25 Meter Stahldraht mit Höheregler

**Dimensions**

↔ Ø82xH32

**Materials**

aluminium 14 | 1M | 2M  
 brass 13 | 16

**Ref**

073.1M white tex  
 073.2M black tex  
 073.13 bronze  
 073.14 alu satin  
 073.16 satin gold

built-up

According to rope diameter, the workload is 4 - 15 kg.  
 nach Seildurchmesser Ø1,25 beträgt die Arbeitslast 4 ñ 15 kg.

073.2../.. - ROSETTE FOR TEXTILE CABLE - TX

~230V  IP20    0.2300 



built-up base - built-up base with strain reliefs for 2 textile cables  
 Aufbaurosette - Aufbaurosette mit Zugentlastung für 2 Textilkabels

**Dimensions**

↔ Ø82xH32

**Materials**

aluminium 14 | 1M | 2M  
 brass 13 | 16

**Ref**

073.2.1M white tex  
 073.2.2M black tex  
 073.2.13 bronze  
 073.2.14 alu satin  
 073.2.16 satin gold

built-up

073.3/.. - ROSETTE FOR TEXTILE CABLE - TX

~230V  IP20    0,2600 



built-up base - built-up base with strain reliefs for 3 textile cables  
 Aufbaurosette - Aufbaurosette mit Zugentlastung für 3 Textilkabels

**Dimensions**  
 ↳ Ø82xH32

**Materials**  
 aluminium 14 | 1M | 2M  
 brass 13 | 16

Ref	
073.3.1M	white tex
073.3.2M	black tex
073.3.13	bronze
073.3.14	alu satin
073.3.16	satin gold

built-up

073B.3/.. - ROSETTE FOR TEXTILE CABLE - TX

~230V  IP20   



built-up base - built-up base with strain reliefs for 3 textile cables + hole for steel cable  
 Aufbaurosette - Aufbaurosette mit Zugentlastung für 3 Textilkabels + Loch für Stahldraht

**Dimensions**  
 ↳ Ø82xH32

**Materials**  
 aluminium 14 | 1M | 2M  
 brass 13 | 16

Ref	
073B.3.1M	white tex
073B.3.2M	black tex
073B.3.13	bronze
073B.3.14	alu satin
073B.3.16	satin gold

built-up  
 steel cable not included  
 Stahldraht nicht einbegriffen

073.4/.. - ROSETTE FOR TEXTILE CABLE - TX

~230V  IP20    0,2800 



built-up base - built-up base with strain reliefs for 4 textile cables  
 Aufbaurosette - Aufbaurosette mit Zugentlastung für 4 Textilkabels

**Dimensions**  
 ↳ Ø82xH32

**Materials**  
 aluminium 14 | 1M | 2M  
 brass 16  
 red copper 28

Ref	
073.4.1M	white tex
073.4.2M	black tex
073.4.14	alu satin
073.4.16	satin gold
073.4.28	rosé

built-up

073.5/.. - ROSETTE FOR TEXTILE CABLE - TX

~230V  IP20   



built-up base - built-up base with strain reliefs for 5 textile cables  
 Aufbaurosette - Aufbaurosette mit Zugentlastung für 5 Textilkabels

**Dimensions**  
 ↳ Ø82xH32

**Materials**  
 aluminium 14 | 1M | 2M  
 brass 13 | 16

Ref	
073.5.1M	white tex
073.5.2M	black tex
073.5.13	bronze
073.5.14	alu satin
073.5.16	satin gold

built-up



001/.. - ROSETTE - M10

III IP20    0,0700 

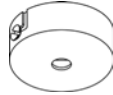

built-up base - round  
Aufbaurosette - rund

**Dimensions**

↔ Ø55xH22

**Options**

P039 - STRAIN RELIEF - TREKONTLASTING  
P040 - STRAIN RELIEF - TREKONTLASTING

**Materials**

aluminium 1 | 2 | 11 | 1M | 2M  
brass 4 | 13 | 16 | 23

**Ref**

001.1	white
001.1M	white tex
001.2	black
001.2M	black tex
001.4	shiny gold
001.11	alu grey
001.13	bronze
001.16	satin gold
001.23	dark bronze

built-up

003/.. - ROSETTE - M10

III IP20    0,1500 



built-up base - round  
Aufbaurosette - rund

**Dimensions**

↔ Ø55xH22

**Options**

P039 - STRAIN RELIEF - TREKONTLASTING  
P040 - STRAIN RELIEF - TREKONTLASTING

**Materials**

aluminium 1 | 2 | 11 | 14 | 1M | 2M  
brass 4 | 13 | 16 | 23

**Ref**

003.1	white
003.1M	white tex
003.2	black
003.2M	black tex
003.4	shiny gold
003.11	alu grey
003.13	bronze
003.14	alu satin
003.16	satin gold
003.23	dark bronze

built-up

004/.. - ROSETTE - M10

III IP20    0,1700 



built-up base - round  
Aufbaurosette - rund

**Dimensions**

↔ Ø60xH24

**Options**

P039 - STRAIN RELIEF - TREKONTLASTING  
P040 - STRAIN RELIEF - TREKONTLASTING

**Materials**

aluminium 1 | 2 | 11 | 14 | 1M | 2M  
brass 4 | 13 | 16 | 23

**Ref**

004.1	white
004.1M	white tex
004.2	black
004.2M	black tex
004.4	shiny gold
004.11	alu grey
004.13	bronze
004.14	alu satin
004.16	satin gold
004.23	dark bronze

built-up

005/.. - ROSETTE - M10

III IP00    0,1700 

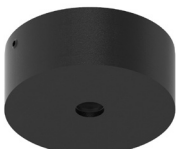

built-up base - round  
Aufbaurosette - rund

**Dimensions**

↔ Ø60xH25

**Options**

P039 - STRAIN RELIEF - TREKONTLASTING  
P040 - STRAIN RELIEF - TREKONTLASTING

**Materials**

aluminium 1 | 2 | 11 | 14 | 1M | 2M  
brass 4 | 13 | 16 | 23

**Ref**

005.1	white
005.1M	white tex
005.2	black
005.2M	black tex
005.4	shiny gold
005.11	alu grey
005.13	bronze
005.14	alu satin
005.16	satin gold
005.23	dark bronze

built-up

2025/.. - ROSETTE - M10

III IP20   0,2250 



built-up base - round  
Aufbaurosette - rund

**Dimensions**

↔ Ø60xH40

**Options**

P039 - STRAIN RELIEF - TREKONTLASTING

P040 - STRAIN RELIEF - TREKONTLASTING

**Materials**

aluminium 1 | 2 | 11 | 14 | 1M | 2M  
brass 4 | 13 | 16 | 23

**Ref**

2025.1	white
2025.1M	white tex
2025.2	black
2025.2M	black tex
2025.4	shiny gold
2025.11	alu grey
2025.13	bronze
2025.14	alu satin
2025.16	satin gold
2025.23	dark bronze

built-up

020/.. - ROSETTE - M10

III IP20   0,2580 



built-up base - round  
Aufbaurosette - rund

**Dimensions**

↔ Ø60xH40

**Options**

P039 - STRAIN RELIEF - TREKONTLASTING

P040 - STRAIN RELIEF - TREKONTLASTING

**Materials**

aluminium 1 | 2 | 11 | 14 | 1M | 2M  
brass 4 | 13 | 16

**Ref**

020.1	white
020.1M	white tex
020.2	black
020.2M	black tex
020.4	shiny gold
020.11	alu grey
020.13	bronze
020.14	alu satin
020.16	satin gold

built-up

021.ZT/.. - ROSETTE - M10

III  IP20   0,1000 



built-up base - round - without transformer  
Aufbaurosette - rund - ohne Trafo

**Dimensions**

↔ Ø60xH65

**Options**

P039 - STRAIN RELIEF - TREKONTLASTING

P040 - STRAIN RELIEF - TREKONTLASTING

**Materials**

aluminium 1 | 2 | 11 | 14 | 1M | 2M  
brass 4 | 13 | 16

**Ref**

021.ZT.1	white
021.ZT.1M	white tex
021.ZT.2	black
021.ZT.2M	black tex
021.ZT.4	shiny gold
021.ZT.11	alu grey
021.ZT.13	bronze
021.ZT.14	alu satin
021.ZT.16	satin gold

built-up

2024/.. - ROSETTE - M12

III IP20   0,1100 



built-up base - round  
Aufbaurosette - rund

**Dimensions**

↔ Ø60xH68

**Materials**

aluminium 1 | 2 | 10 | 11 | 1M | 2M

**Ref**

2024.1	white
2024.1M	white tex
2024.2	black
2024.2M	black tex
2024.10	alu grey
2024.11	alu grey

built-up  
only for profiles  
nur für Profile

061/.. - ROSETTE - M10

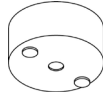

built-up base - base for built-up spotlight  
Aufbaurosette - Basis für Aufbaustrahler

**Dimensions**

↔ Ø62xH30

**Options**

P039 - STRAIN RELIEF - TREKONTLASTING  
P040 - STRAIN RELIEF - TREKONTLASTING

**Materials**

aluminium 14 | 1M | 2M  
brass 4 | 13 | 16 | 23

**Ref**

061.1M	white tex
061.2M	black tex
061.4	shiny gold
061.13	bronze
061.14	alu satin
061.16	satin gold
061.23	dark bronze

built-up

053/.. - OPHANGING VOOR PENDEL - M10

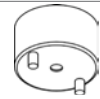

built-up base for pendant - round  
Aufbaubase für Pendelleuchte - rund

**Dimensions**

↔ Ø70xH40

**Options**

P039 - STRAIN RELIEF - TREKONTLASTING  
P040 - STRAIN RELIEF - TREKONTLASTING

**Materials**

aluminium 14 | 1M | 2M | 46  
brass 4 | 13 | 16 | 23  
red copper 28

**Ref**

053.1M	white tex
053.2M	black tex
053.4	shiny gold
053.13	bronze
053.14	alu satin
053.16	satin gold
053.23	dark bronze
053.28	rosé
053.46	grey-brown

built-up

049/.. - ROZET VOOR OPBOUWSPOT - M10

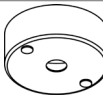

built-up base for spot - round  
Aufbaubase für Aufbaustrahler - rund

**Dimensions**

↔ Ø80xH30

**Options**

P039 - STRAIN RELIEF - TREKONTLASTING  
P040 - STRAIN RELIEF - TREKONTLASTING

**Materials**

aluminium 14 | 1M | 2M

**Ref**

049.1M	white tex
049.2M	black tex
049.14	alu satin

built-up

042/.. - ROZET VOOR OPBOUWSPOT - M10

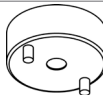

built-up base for spot - round  
Aufbaubase für Aufbaustrahler - rund

**Dimensions**

↔ Ø80xH30

**Options**

P039 - STRAIN RELIEF - TREKONTLASTING  
P040 - STRAIN RELIEF - TREKONTLASTING

**Materials**

aluminium 14 | 1M | 2M

**Ref**

042.1M	white tex
042.2M	black tex
042.14	alu satin

built-up

050/.. - ROZET VOOR OPBOUWSPOT - M10

~230V



built-up base for spot - round - with LED driver  
 Aufbaubase für Aufbaustrahler - rund - mit Driver LED

**Dimensions**

↔ Ø80xH55

**Options**

P039 - STRAIN RELIEF - TREKONTLASTING  
 P040 - STRAIN RELIEF - TREKONTLASTING

**Materials**

aluminium 14 | 1M | 2M

**Ref**

050.1M	white tex
050.2M	black tex
050.14	alu satin

built-up  
 12W 700mA - not dimmable  
 nicht dimmbar

043/.. - ROZET VOOR OPBOUWSPOT - M10

~230V



built-up base for spot - round - with LED driver  
 Aufbaubase für Aufbaustrahler - rund - mit Driver LED

**Dimensions**

↔ Ø80xH55

**Options**

P039 - STRAIN RELIEF - TREKONTLASTING  
 P040 - STRAIN RELIEF - TREKONTLASTING

**Materials**

aluminium 14 | 1M | 2M

**Ref**

043.1M	white tex
043.2M	black tex
043.14	alu satin

built-up  
 12W 700mA - not dimmable  
 nicht dimmbar

032/.. - ROSETTE - M10



built-up base - for suspension light with 3 steel cables  
 Aufbaurosette - für Hängelampe mit 3 Stahlkabels

**Dimensions**

↔ Ø100xH32

↻ Ø80

**Materials**

aluminium 1 | 11 | 14 | 1M | 2M  
 brass 4 | 13 | 16

**Ref**

032.1	white
032.1M	white tex
032.2M	black tex
032.4	shiny gold
032.11	alu grey
032.13	bronze
032.14	alu satin
032.16	satin gold

built-up

1559/.. - ROSETTE - M10



built-up base - round  
 Aufbaurosette - rund

**Dimensions**

↔ Ø80xH40

**Options**

RSD35005E - DRIVER  
 RSD50007E - DRIVER

**Materials**

aluminium 14 | 1M | 2M  
 brass 4 | 13 | 23

**Ref**

1559.1M	white tex
1559.2M	black tex
1559.4	shiny gold
1559.13	bronze
1559.14	alu satin
1559.23	dark bronze

built-up



033.B3.D8,3/.. - ROZET VOOR PENDEL - B3



built-up base for pendant - round - with swivel B3  
 Aufbaubase für Pendelleuchte - rund - mit Kugelgelenk B3

**Dimensions**  
 ↔ Ø60xH40

**Materials**  
 aluminium 14 | 1M | 2M  
 brass 4 | 13 | 23

Ref	
033.B3.D8.3.1M	white tex
033.B3.D8.3.2M	black tex
033.B3.D8.3.4	shiny gold
033.B3.D8.3.13	bronze
033.B3.D8.3.14	alu satin
033.B3.D8.3.23	dark bronze

built-up

033.B3.D12/.. - ROZET VOOR PENDEL - B3

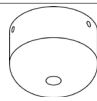

built-up base for pendant - round - with swivel B3 - rod  
 Ø12mm  
 Aufbaubase für Pendelleuchte - rund - mit Kugelgelenk B3 -  
 Stange Ø12mm

**Dimensions**  
 ↔ Ø60xH40

**Materials**  
 aluminium 14 | 1M | 2M  
 brass 4 | 13 | 23

Ref	
033.B3.D12.1M	white tex
033.B3.D12.2M	black tex
033.B3.D12.4	shiny gold
033.B3.D12.13	bronze
033.B3.D12.14	alu satin
033.B3.D12.23	dark bronze

built-up

060.B3.D8,3/.. - ROSETTE for pendant - B3

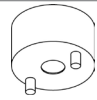

built-up base - built-up base for bar Ø8mm B3  
 Aufbaurosette - Aufbaurosette für Stange Ø8mm B3

**Dimensions**  
 ↔ Ø70xH40

**Materials**  
 aluminium 14 | 1M | 2M  
 brass 4 | 13 | 16 | 23  
 red copper 28

Ref	
060.B3.D8.3.1M	white tex
060.B3.D8.3.2M	black tex
060.B3.D8.3.4	shiny gold
060.B3.D8.3.13	bronze
060.B3.D8.3.14	alu satin
060.B3.D8.3.16	satin gold
060.B3.D8.3.23	dark bronze
060.B3.D8.3.28	rosé

built-up

060.B3.D12/.. - ROSETTE for pendant - B3



built-up base - built-up rosette for bar Ø12 mm B3  
 Aufbaurosette

**Dimensions**  
 ↔ Ø70xH40

**Materials**  
 aluminium 14 | 1M | 2M  
 brass 4 | 13 | 16 | 23  
 red copper 28

Ref	
060.B3.D12.1M	white tex
060.B3.D12.2M	black tex
060.B3.D12.4	shiny gold
060.B3.D12.13	bronze
060.B3.D12.14	alu satin
060.B3.D12.16	satin gold
060.B3.D12.23	dark bronze
060.B3.D12.28	rosé

built-up

020.B3/./.. - ROSETTE -M10-M8-M6-D8,3 - B3

IP20



built-up base - round - with swivel B3  
Aufbaurosette - rund - mit Kugelgelenk B3

Materials

aluminium 1 | 2 | 11 | 14 | 1M | 2M  
brass 4 | 13 | 16

Dimensions

Ø54xH60

Colour	020. B3.D8,3/..	020. B3.M10/..	020. B3.M6/..	020. B3.M8/..
	Ø	Ø	Ø	Ø
1				
1M				
2				
2M				
4				
11				
13				
14				
16				

**built-up**  
for pendants only - not for spots  
nur für Hängeleuchte - nicht für Aufbaustrahler

021.B3.ZT.D8,3/.. - ROSETTE - B3

IP20



built-up base - round - with swivel B3  
Aufbaurosette - rund - mit Kugelgelenk B3

Ref

021.B3.ZT.D8.3.1 white  
021.B3.ZT.D8.3.1M white tex  
021.B3.ZT.D8.3.2 black  
021.B3.ZT.D8.3.2M black tex  
021.B3.ZT.D8.3.4 shiny gold  
021.B3.ZT.D8.3.11 alu grey  
021.B3.ZT.D8.3.13 bronze  
021.B3.ZT.D8.3.14 alu satin  
021.B3.ZT.D8.3.16 satin gold

Dimensions

Ø60xH90

Materials

aluminium 1 | 2 | 11 | 14 | 1M | 2M  
brass 4 | 13 | 16

**built-up**  
for pendants only - not for spots  
nur für Hängeleuchte - nicht für Aufbaustrahler

034.B3/.. - ROZET VOOR PENDEL - B3

IP20

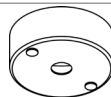
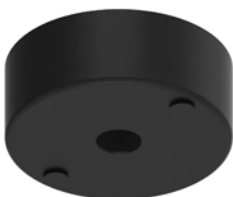

built-up base for pendant - round - with swivel B3  
Aufbaubase für Pendelleuchte - rund - mit Kugelgelenk B3

Ref

034.B3.1M white tex  
034.B3.2M black tex  
034.B3.4 shiny gold  
034.B3.13 bronze  
034.B3.14 alu satin  
034.B3.23 dark bronze

Dimensions

Ø80xH30

Materials

aluminium 14 | 1M | 2M  
brass 4 | 13 | 23

**built-up**

035/.. - ROZET VOOR PENDEL - B3

~230V



built-up base for pendant - round - with swivel B3 - with LED driver  
 Aufbaubase für Pendelleuchte - rund - mit Kugelgelenk B3 - mit Driver LED

**Dimensions**

Ø80xH55

**Materials**

aluminium 14 | 1M | 2M  
 brass 4 | 13 | 23

**Ref**

035.1M	white tex
035.2M	black tex
035.4	shiny gold
035.13	bronze
035.14	alu satin
035.23	dark bronze

built-up  
 12W 700mA - not dimmable  
 12W 700mA - nicht dimmbar

037.B3.D8,3/.. - ROSETTE - B3

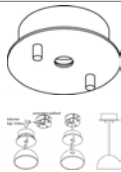

built-up base - for pendant with swivel B3 - for rod Ø8mm  
 Aufbaurosette - für Pendelleuchte mit Kugelgelenk B3 - für Stange Ø8mm

**Dimensions**

Ø100xH32

Ø75

**Materials**

aluminium 1 | 11 | 14 | 1M | 2M  
 brass 4 | 13 | 16

**Ref**

037.B3.D8.3.1	white
037.B3.D8.3.1M	white tex
037.B3.D8.3.2M	black tex
037.B3.D8.3.4	shiny gold
037.B3.D8.3.11	alu grey
037.B3.D8.3.13	bronze
037.B3.D8.3.14	alu satin
037.B3.D8.3.16	satin gold

built-up

037.B3.D12/.. - ROSETTE - B3

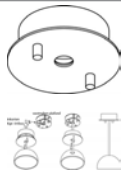

built-up base - for pendant with swivel B3 - for rod Ø12mm  
 Aufbaurosette - für Pendelleuchte mit Kugelgelenk B3 - für Stange Ø12mm

**Dimensions**

Ø100xH32

Ø75

**Options**

4054 - MONA LISA Ø550  
 4055 - MONA LISA Ø450

**Materials**

aluminium 1 | 11 | 14 | 1M | 2M  
 brass 4 | 13 | 16 | 23

**Ref**

037.B3.D12.1	white
037.B3.D12.1M	white tex
037.B3.D12.2M	black tex
037.B3.D12.4	shiny gold
037.B3.D12.11	alu grey
037.B3.D12.13	bronze
037.B3.D12.14	alu satin
037.B3.D12.16	satin gold
037.B3.D12.23	dark bronze

built-up

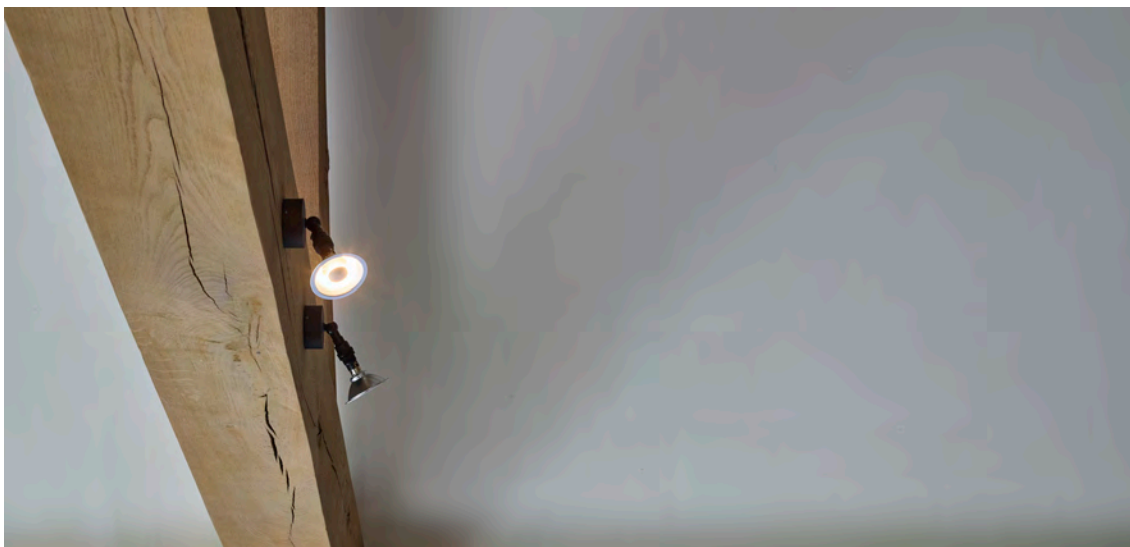

006/.. - TRANSFORMER BOX



transformer box - empty - without transformer  
Trafogehäuse - leer - ohne Trafo

**Dimensions**

↔ L90xB39xH90

**Materials**

aluminium 1 | 2 | 11 | 14 | 1M | 2M  
brass 4 | 13 | 16

**Ref**

006.1	white
006.1M	white tex
006.2	black
006.2M	black tex
006.4	shiny gold
006.11	alu grey
006.13	bronze
006.14	alu satin
006.16	satin gold

built-up

028/.. - ROSETTE - M10

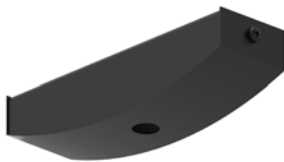

built-up base  
Aufbaurosette

**Dimensions**

↔ L115xB32xH27

**Materials**

aluminium 1 | 2 | 11 | 14 | 1M | 2M  
brass 4 | 13 | 16

**Ref**

028.1	white
028.1M	white tex
028.2	black
028.2M	black tex
028.4	shiny gold
028.11	alu grey
028.13	bronze
028.14	alu satin
028.16	satin gold

built-up

030/.. - ROSETTE - M10



built-up base  
Aufbaudose

**Dimensions**

↔ Ø70xH30

**Materials**

aluminium 1 | 2 | 11 | 1M | 2M  
brass 4 | 13 | 16 | 23

**Ref**

030.1	white
030.1M	white tex
030.2	black
030.2M	black tex
030.4	shiny gold
030.11	alu grey
030.13	bronze
030.16	satin gold
030.23	dark bronze

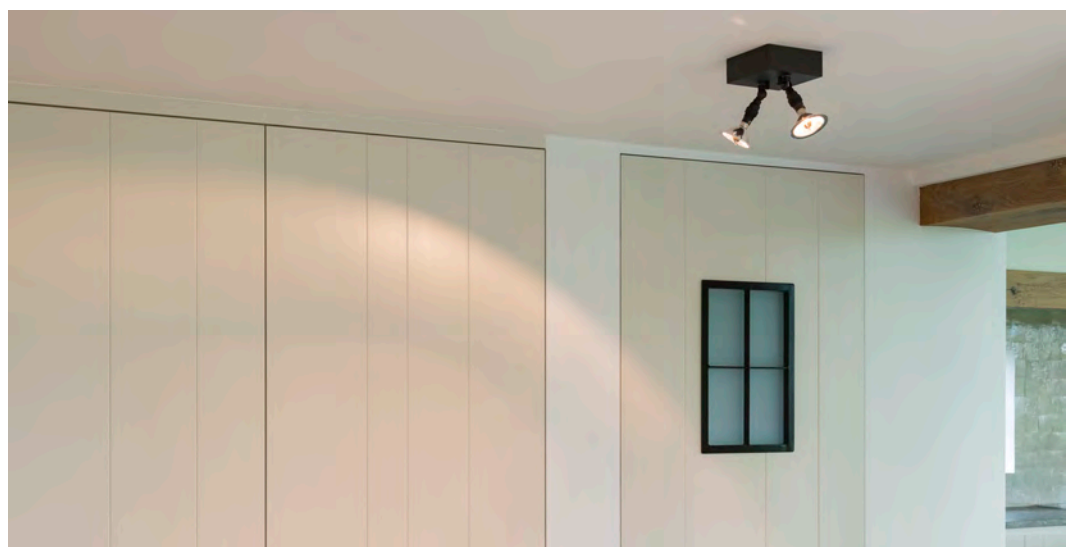



017/.. - ROSETTE - M10

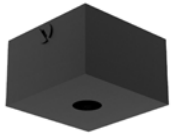

built-up base - square  
Aufbaurosette - viereckig

**Dimensions**

↔ L40xB40xH25

**Materials**

aluminium 1 | 2 | 11 | 14 | 1M | 2M  
brass 4 | 13 | 16 | 23

**Ref**

017.1 white  
017.1M white tex  
017.2 black  
017.2M black tex  
017.4 shiny gold  
017.11 alu grey  
017.13 bronze  
017.14 alu satin  
017.16 satin gold  
017.23 dark bronze

built-up

025/.. - ROSETTE - M10



built-up base - square  
Aufbaurosette - viereckig

**Dimensions**

↔ L60xB60xH25

**Materials**

aluminium 1 | 2 | 11 | 14 | 1M | 2M  
brass 4 | 13 | 16

**Ref**

025.1 white  
025.1M white tex  
025.2 black  
025.2M black tex  
025.4 shiny gold  
025.11 alu grey  
025.13 bronze  
025.14 alu satin  
025.16 satin gold

built-up

027/.. - ROSETTE - M10



built-up base - square  
Aufbaurosette - viereckig

**Dimensions**

↔ L60xB60xH40

**Materials**

aluminium 1 | 2 | 11 | 14 | 1M | 2M  
brass 4 | 13 | 16

**Ref**

027.1 white  
027.1M white tex  
027.2 black  
027.2M black tex  
027.4 shiny gold  
027.11 alu grey  
027.13 bronze  
027.14 alu satin  
027.16 satin gold

built-up

026.ZT/.. - ROSETTE - M10



built-up base - square - without transformer  
Aufbaurosette - viereckig - ohne Trafo

**Dimensions**

↔ L60xB60xH65

**Materials**

aluminium 1 | 2 | 11 | 14 | 1M | 2M  
brass 4 | 13 | 16 | 23

**Ref**

026.ZT.1 white  
026.ZT.1M white tex  
026.ZT.2 black  
026.ZT.2M black tex  
026.ZT.4 shiny gold  
026.ZT.11 alu grey  
026.ZT.13 bronze  
026.ZT.14 alu satin  
026.ZT.16 satin gold  
026.ZT.23 dark bronze

built-up

1144/.. - ROSETTE UP - M10

IP20  



built-up base - square  
Aufbaurosette - viereckig

**Dimensions**

L60xB40xH30

**Materials**

aluminium

**Ref**

1144.1M

1144.2M

1144.14

white tex

black tex

alu satin

14 | 1M | 2M

built-up



025.B3/./... - ROSETTE-M10-M8-M6-D8,3 - B3

IP20   

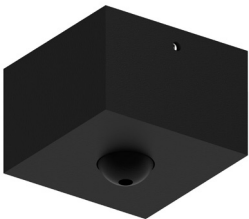

built-up base - square - with swivel B3  
Aufbaurosette - viereckig - mit Kugelgelenk B3

**Dimensions**

L60xB60xH40

**Materials**

aluminium

brass

1 | 2 | 11 | 14 | 1M | 2M

4 | 13 | 16

Colour	025. B3.D8,3/..	025. B3.M10/..	025. B3.M6/..	025. B3.M8/..
	Ø	Ø	Ø	Ø
1				
1M				
2				
2M				
4				
11				
13				
14				
16				

built-up

for pendants only - not for spots  
nur für Hängeleuchte - nicht für Aufbaustrahler



066/.. - ROSETTE HOOK - HOOK

~230V  IP20   



round - built-up rosette with closed hook for suspension  
rund - Aufbaurosette mit geschlossenem Haken für Pendel

**Dimensions**  
↔ Ø70xH40

**Materials**  
aluminium 14 | 1M | 2M  
brass 4 | 13 | 16 | 23

Ref	
066.1M	white tex
066.2M	black tex
066.4	shiny gold
066.13	bronze
066.14	alu satin
066.16	satin gold
066.23	dark bronze

built-up  
max 10kg

064/.. - ROSETTE HOOK

~230V  IP20    0,1500 



round - built-up rosette with open hook for suspension  
rund - Aufbaurosette mit offenem Haken für Pendel

**Dimensions**  
↔ Ø70xH40

**Materials**  
INOX 32X | 37X | 46X | 31MX  
INOX 316 5 | 5BB

Ref	
064.5	inox 316
064.5BB	inox 316 2x coated
064.31MX	white texture
064.32X	black texture
064.37X	grey texture
064.46X	grey-brown

built-up

067/.. - ROSETTE HOOK

~230V  IP20   



square - built-up rosette with closed hook for suspension  
viereckig - Aufbaurosette mit geschlossenem Haken für Pendel

**Dimensions**  
↔ L70xB70xH40  
↖ L60xB60

**Materials**  
aluminium 14 | 1M | 2M  
brass 4 | 13 | 16 | 23

Ref	
067.1M.1M	white tex
067.2M	black tex
067.4.2M	shiny gold
067.13.2M	bronze
067.14	alu satin
067.16.2M	satin gold
067.23.2M	dark bronze

built-up

068/.. - ROSETTE HOOK

~230V  IP20    0,4200 



square - built-up rosette with open hook for suspension  
viereckig - Aufbaurosette mit offenem Haken für Pendel

**Dimensions**  
↔ L80xB80xH40  
↖ L70xB70

**Materials**  
aluminium 14 | 1M | 2M  
brass 4 | 13 | 16 | 23

Ref	
068.1M	white tex
068.2M	black tex
068.4.2M	shiny gold
068.13.2M	bronze
068.14	alu satin
068.16.2M	satin gold
068.23.2M	dark bronze

built-up

063/.. - ROSETTE for B3



built-up rosette B3 for rod Ø12mm  
Aufbaurosette B3 für Stange Ø12mm

**Dimensions**

↔ L70xB70xH43

↕ L60xB60xH43

**Materials**

INOX 32X | 37X | 46X | 31MX  
INOX 316 5 | 5B

**Ref**

063.5	inox 316
063.5B	inox 316 1x coated
063.31MX	white texture
063.32X	black texture
063.37X	grey texture
063.46X	grey-brown

built-up

062/.. - ROSETTE for chain

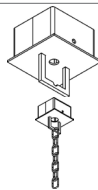

built-up rosette for chain polo  
Aufbaurosette für Kette Polo

**Dimensions**

↔ L70xB70xH75

↕ L65xB65xH43

**Materials**

INOX 32X | 37X | 46X | 31MX  
INOX 316 5 | 5BB

**Ref**

062.5	inox 316
062.5BB	inox 316 2x coated
062.31MX	white texture
062.32X	black texture
062.37X	grey texture
062.46X	grey-brown

built-up

069/.. - ROSETTE HOOK



built-up rosette with closed hook for suspension  
Aufbaurosette mit geschlossenem Haken für Pendel

**Dimensions**

↔ L70xB70xH40

**Materials**

INOX 304 32X | 46X | 53X

**Ref**

069.32X	black texture
069.46X	grey-brown
069.53X	bronze-brown

built-up

070/.. - ROSETTE HOOK



built-up rosette with open hook for suspension  
Aufbaurosette mit offenem Haken für Pendel

**Dimensions**

↔ L70xB70xH40

**Materials**







INOX 304 32X | 46X | 53X

**Ref**

070.32X	black texture
070.46X	grey-brown
070.53X	bronze-brown

built-up

923.ZT/.. - RONDO BOX - M10

~230V   IP20    0,2100 



ceiling light - spot to be ordered separately - without transformer  
Deckenleuchte - Strahler separat zu bestellen - ohne Trafo

**Dimensions**

Ø100xH52  
Ø80

**Options**

TR122790 - DRIVER  
TR122792 - DRIVER  
TR122794 - DRIVER

**Materials**





aluminium 1 | 2 | 11 | 14 | 1M | 2M  
brass 4 | 13 | 16

**Ref**

923.ZT.1 white  
923.ZT.1M white tex  
923.ZT.2 black  
923.ZT.2M black tex  
923.ZT.4 shiny gold  
923.ZT.11 alu grey  
923.ZT.13 bronze  
923.ZT.14 alu satin  
923.ZT.16 satin gold

built-up

821.ZT/.. - RONDO BOX - M10

~230V   IP20    0,4800 

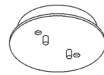

ceiling light - spots to be ordered separately - without transformer  
Deckenleuchte - Strahler separat zu bestellen - ohne Trafo

**Dimensions**

Ø150xH43  
Ø125

**Options**

TR127040 - DRIVER  
TR127042 - DRIVER  
TR127046 - DRIVER

**Materials**

aluminium 1 | 2 | 11 | 14 | 1M | 2M  
brass 4 | 13 | 16







**Ref**

821.ZT.1 white  
821.ZT.1M white tex  
821.ZT.2 black  
821.ZT.2M black tex  
821.ZT.4 shiny gold  
821.ZT.11 alu grey  
821.ZT.13 bronze  
821.ZT.14 alu satin  
821.ZT.16 satin gold

built-up

Led driver 12V Max. 40W

822.ZT/.. - RONDO BOX - M10

~230V   IP20    0,5000 

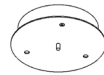
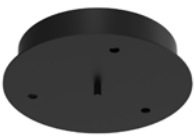

ceiling light - spots to be ordered separately - without transformer  
Deckenleuchte - Strahler separat zu bestellen - ohne Trafo

**Dimensions**

Ø200xH43  
Ø170

**Options**

TR127040 - DRIVER  
TR127042 - DRIVER  
TR127046 - DRIVER

**Materials**

aluminium 1 | 2 | 11 | 14 | 1M | 2M  
brass 4 | 13 | 16

**Ref**





822.ZT.1 white  
822.ZT.1M white tex  
822.ZT.2 black  
822.ZT.2M black tex  
822.ZT.4 shiny gold  
822.ZT.11 alu grey  
822.ZT.13 bronze  
822.ZT.14 alu satin  
822.ZT.16 satin gold

built-up

Led driver 12V Max. 2x40W



925C.ZT/.. - RONDO BOX - M10

~230V   IP20   

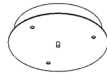
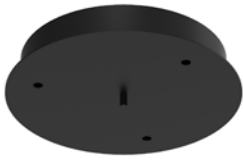

ceiling light - spots to be ordered separately - without transformer  
Deckenleuchte - Strahler separat zu bestellen - ohne Trafo

**Dimensions**

↔ Ø250xH43

⌀220

**Options**

TR127040 - DRIVER

TR127042 - DRIVER

TR127046 - DRIVER

**Materials**

aluminium 1 | 2 | 11 | 14 | 1M | 2M

brass 4 | 13 | 16

**Ref**

925C.ZT.1	white
925C.ZT.1M	white tex
925C.ZT.2	black
925C.ZT.2M	black tex
925C.ZT.4	shiny gold
925C.ZT.11	alu grey
925C.ZT.13	bronze
925C.ZT.14	alu satin
925C.ZT.16	satin gold

*built-up*

*Led driver 12V Max. 2x40W*

925D.ZT/.. - RONDO BOX - M10

~230V   IP20   

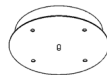

ceiling light - spots to be ordered separately - without transformer  
Deckenleuchte - Strahler separat zu bestellen - ohne Trafo

**Dimensions**

↔ Ø250xH43

⌀220

**Options**

TR127040 - DRIVER

TR127042 - DRIVER

TR127046 - DRIVER

**Materials**

aluminium 1 | 2 | 11 | 14 | 1M | 2M

brass 4 | 13 | 16

**Ref**

925D.ZT.1	white
925D.ZT.1M	white tex
925D.ZT.2	black
925D.ZT.2M	black tex
925D.ZT.4	shiny gold
925D.ZT.11	alu grey
925D.ZT.13	bronze
925D.ZT.14	alu satin
925D.ZT.16	satin gold

*built-up*

*Led driver 12V Max. 2x40W*



924A/.. - RONDO BOX - M10

~230V  IP20   1,1580 



ceiling light - spot to be ordered separately  
Deckenleuchte - Strahler separat zu bestellen

**Dimensions**

↔ Ø100xH25

⤵ Ø80

**Options**

P039 - STRAIN RELIEF - TREKONTLASTING

P040 - STRAIN RELIEF - TREKONTLASTING

**Materials**

aluminium 1 | 2 | 11 | 14 | 1M | 2M





brass 4 | 13 | 16

**Ref**

924A.1	white
924A.1M	white tex
924A.2	black
924A.2M	black tex
924A.4	shiny gold
924A.11	alu grey
924A.13	bronze
924A.14	alu satin
924A.16	satin gold

built-up

924B/.. - RONDO BOX - M10

~230V  IP20   0,5700 



ceiling light - spots to be ordered separately  
Deckenleuchte - Strahler separat zu bestellen

**Dimensions**

↔ Ø100xH25

⤵ Ø80

**Options**

P039 - STRAIN RELIEF - TREKONTLASTING

P040 - STRAIN RELIEF - TREKONTLASTING

**Materials**

aluminium 1 | 2 | 11 | 14 | 1M | 2M

brass 4 | 13 | 16

**Ref**

924B.1	white
924B.1M	white tex
924B.2	black
924B.2M	black tex
924B.4	shiny gold
924B.11	alu grey
924B.13	bronze
924B.14	alu satin
924B.16	satin gold

built-up

823/.. - RONDO BOX - M10

~230V  IP20   0,6200 



ceiling light - spots to be ordered separately  
Deckenleuchte - Strahler separat zu bestellen

**Dimensions**

↔ Ø150xH25

⤵ Ø125

**Options**

P039 - STRAIN RELIEF - TREKONTLASTING

P040 - STRAIN RELIEF - TREKONTLASTING

**Materials**

aluminium 1 | 2 | 11 | 14 | 1M | 2M





brass 4 | 13 | 16 | 23

**Ref**

823.1	white
823.1M	white tex
823.2	black
823.2M	black tex
823.4	shiny gold
823.11	alu grey
823.13	bronze
823.14	alu satin
823.16	satin gold
823.23	dark bronze

built-up

824/.. - RONDO BOX - M10

~230V  IP20   0,9800 

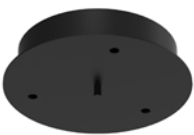

ceiling light - spots to be ordered separately  
Deckenleuchte - Strahler separat zu bestellen

**Dimensions**

↔ Ø200xH25

⤵ Ø175

**Options**

P039 - STRAIN RELIEF - TREKONTLASTING

P040 - STRAIN RELIEF - TREKONTLASTING

**Materials**

aluminium 1 | 2 | 11 | 14 | 1M | 2M

brass 4 | 13 | 16

**Ref**

824.1	white
824.1M	white tex
824.2	black
824.2M	black tex
824.4	shiny gold
824.11	alu grey
824.13	bronze
824.14	alu satin
824.16	satin gold

built-up

926C/.. - RONDO BOX - M10

~230V



IP20



1,7996

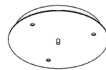
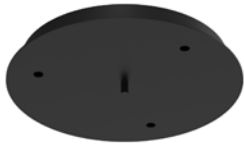

ceiling light - spots to be ordered separately  
Deckenleuchte - Strahler separat zu bestellen

**Dimensions**

↔ Ø250xH26

↙ Ø220

**Options**

P039 - STRAIN RELIEF - TREKONTLASTING

P040 - STRAIN RELIEF - TREKONTLASTING

**Materials**

aluminium

1 | 2 | 11 | 14 | 1M | 2M

brass

4 | 13 | 16

**Ref**

926C.1

white

926C.1M

white tex

926C.2

black

926C.2M

black tex

926C.4

shiny gold

926C.11

alu grey

926C.13

bronze

926C.14

alu satin

926C.16

satin gold

built-up

926D/.. - RONDO BOX - M10

~230V



IP20



1,7950

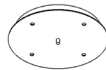

ceiling light - spots to be ordered separately  
Deckenleuchte - Strahler separat zu bestellen

**Dimensions**

↔ Ø250xH26

↙ Ø220

**Options**

P039 - STRAIN RELIEF - TREKONTLASTING

P040 - STRAIN RELIEF - TREKONTLASTING

**Materials**

aluminium

1 | 2 | 11 | 14 | 1M | 2M

brass

4 | 13 | 16

**Ref**

926D.1

white

926D.1M

white tex

926D.2

black

926D.2M

black tex

926D.4

shiny gold

926D.11

alu grey

926D.13

bronze

926D.14

alu satin



926D.16

satin gold

built-up



962/.. - RONDO BOX - M10

~230V  IP20    2,2000 

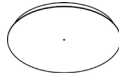

ceiling light - Ø300mm without holes- spots or pendants to be ordered separately  
Deckenleuchte - Ø 300mm ohne Locher - Strahler oder Hängelampen separat bestellen

**Dimensions**

↔ Ø300xH28

↖ ↗ Ø270

**Options**

000C - TREKONTLASTING PER PENDEL TEXTILE

000CR - TREKONTLASTING PER PENDEL TEXTILE

**Materials**



aluminium 14 | 1M | 2M

**Ref**

962.1M	white tex
962.2M	black tex
962.14	alu satin
962.14.11	alu satin

built-up

963/.. - RONDO BOX - M10

~230V  IP20    2,6600 

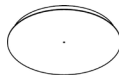

ceiling light - Ø350mm without holes - spots or pendants to be ordered separately  
Deckenleuchte - Ø350mm ohne Locher - Strahler oder Hängelampen separat bestellen

**Dimensions**

↔ Ø350xH28

↖ ↗ Ø320

**Options**

000C - TREKONTLASTING PER PENDEL TEXTILE

000CR - TREKONTLASTING PER PENDEL TEXTILE

**Materials**

aluminium 14 | 1M | 2M

**Ref**

963.1M	white tex
963.2M	black tex
963.14	alu satin
963.14.11	alu satin

built-up

964/.. - RONDO BOX - M10

~230V  IP20    2,1800 



ceiling light - Ø400mm without holes- spots or pendants to be ordered separately  
Deckenleuchte - Ø400mm ohne Locher - Strahler oder Hängelampen separat bestellen

**Dimensions**

↔ Ø400xH28

↖ ↗ Ø370

**Options**

000C - TREKONTLASTING PER PENDEL TEXTILE

000CR - TREKONTLASTING PER PENDEL TEXTILE

**Materials**

aluminium 14 | 1M | 2M

**Ref**

964.1M	white tex
964.2M	black tex
964.14	alu satin
964.14.11	alu satin

built-up

965/.. - RONDO BOX - M10

~230V  IP20    4,2200 



ceiling light - Ø500mm without holes- spots or pendants to be ordered separately  
Deckenleuchte - Ø500mm ohne Locher - Strahler oder Hängelampen separat bestellen

**Dimensions**

↔ Ø500xH28

↖ ↗ Ø470

**Options**

000C - TREKONTLASTING PER PENDEL TEXTILE

000CR - TREKONTLASTING PER PENDEL TEXTILE

**Materials**

aluminium 14 | 1M | 2M

**Ref**

965.1M	white tex
965.2M	black tex
965.14	alu satin
965.14.11	alu satin

built-up







966/.. - RONDO BOX - M10

~230V  IP20    5,3100 



ceiling light - Ø600mm without holes- spots or pendants to be ordered separately  
Deckenleuchte

**Dimensions**

↔ Ø600xH28

↖ Ø570

**Options**

000C - TREKONTLASTING PER PENDEL TEXTILE

000CR - TREKONTLASTING PER PENDEL TEXTILE

**Materials**

aluminium 14 | 1M | 2M

**Ref**

966.1M	white tex
966.2M	black tex
966.14	alu satin
966.14.11	alu satin

built-up

000B3/.. - JUBA supplement SWIVEL

IP20   0,0010 

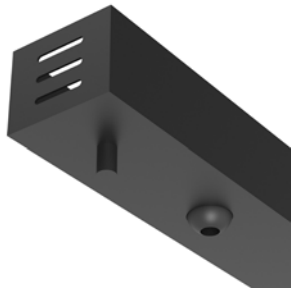





supplement - additional cost for drilling the holes for pendant with swivel  
Supplement - zusätzliche Kosten für Ausbohrung Löcher für Pendelleuchte mit Kugelgelenk

**Ref**

000B3

000C/.. - TREKONTLASTING PER PENDEL TEXTILE

IP20    0,0600 

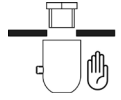
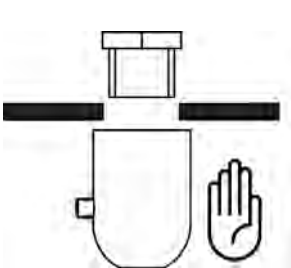

drawing holes + drilling + strain relief  
Zeichnen Locher + Bohrung + Zugentlastung

**Dimensions**

↔ Ø15xH21





**Materials**

aluminium 11 | 14 | 1M | 21 | 2M | 46 | 53  
brass 13 | 16 | 23

**Ref**

000C.1M	white tex
000C.2M	black tex
000C.11	alu grey
000C.13	bronze
000C.14	alu satin
000C.16	satin gold
000C.21	rust
000C.23	dark bronze
000C.46	grey-brown
000C.53	bronze-brown

000CR/.. - TREKONTLASTING PER PENDEL TEXTILE

IP20    0,0400 

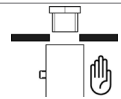
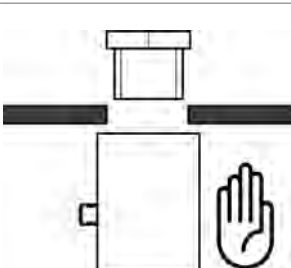

drawing holes + drilling + strain relief  
Zeichnen Locher + Bohrung + Zugentlastung

**Dimensions**

↔ Ø15xH21

**Materials**

aluminium 1 | 2 | 11 | 14 | 1M | 21 | 2M | 44 | 46 | 53  
brass 4 | 13 | 16 | 23

**Ref**

000CR.1	white
000CR.1M	white tex
000CR.2	black
000CR.2M	black tex
000CR.4	shiny gold
000CR.11	alu grey
000CR.13	bronze
000CR.14	alu satin
000CR.16	satin gold
000CR.21	rust
000CR.23	dark bronze
000CR.44	anthracite grey
000CR.46	grey-brown
000CR.53	bronze-brown

built-up



927/.. - OVALE BOX - M10

~230V  IP20    0,1620 

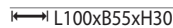

ceiling light - no room for transformer  
Deckenleuchte - kein Platz für Trafo

**Dimensions**

 L100xB55xH30  
 L60xB33

**Materials**

aluminium 1 | 2 | 11 | 14 | 1M | 2M  
brass 4 | 13 | 16

**Ref**

927.1 white  
927.1M white tex  
927.2 black  
927.2M black tex  
927.4 shiny gold  
927.11 alu grey  
927.13 bronze  
927.14 alu satin  
927.16 satin gold

**built-up**  
230V - spot to be ordered separately  
Strahler separat zu bestellen

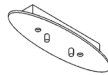

928/.. - OVALE BOX - M10

~230V  IP20    0,4200 



ceiling light - no room for transformer  
Deckenleuchte - kein Platz für Trafo

**Dimensions**

 L240xB70xH30  
 L160xB35

**Materials**

aluminium 1 | 2 | 11 | 14 | 1M | 2M  
brass 4 | 13 | 16

**Ref**

928.1 white  
928.1M white tex  
928.2 black  
928.2M black tex  
928.4 shiny gold  
928.11 alu grey  
928.13 bronze  
928.14 alu satin  
928.16 satin gold

**built-up**  
230V - spots to be ordered separately  
Strahler separat zu bestellen

929/.. - OVALE BOX - M10

~230V  IP20    0,6200 

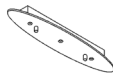

ceiling light - no room for transformer  
Deckenleuchte - kein Platz für Trafo

**Dimensions**

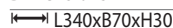
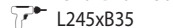
 L340xB70xH30  
 L245xB35

**Materials**

aluminium 1 | 2 | 11 | 14 | 1M | 2M  
brass 4 | 13 | 16

**Ref**

929.1 white  
929.1M white tex  
929.2 black  
929.2M black tex  
929.4 shiny gold  
929.11 alu grey  
929.13 bronze  
929.14 alu satin  
929.16 satin gold

**built-up**  
230V - spots to be ordered separately  
Strahler separat zu bestellen

930/.. - OVALE BOX - M10

~230V  IP20    0,8600 

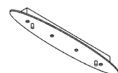

ceiling light - no room for transformer  
Deckenleuchte - kein Platz für Trafo

**Dimensions**

 L440xB70xH30  
 L335xB35

**Materials**

aluminium 1 | 2 | 11 | 14 | 1M | 2M  
brass 4 | 13 | 16

**Ref**

930.1 white  
930.1M white tex  
930.2 black  
930.2M black tex  
930.4 shiny gold  
930.11 alu grey  
930.13 bronze  
930.14 alu satin  
930.16 satin gold

**built-up**  
230V - spots to be ordered separately  
Strahler separat zu bestellen

1518/.. - OVALE BOX - M10

~230V



IP20



ceiling light - place for driver  
Deckenleuchte - Platz für den Driver

**Dimensions**

↔ L800xB270xH30

⤴ L640xB140

**Materials**

aluminium

14 | 1M | 2M

brass

13 | 16 | 23

**Ref**

1518.1M

white tex

1518.1M.2M

white tex

1518.2M

black tex

1518.2M.1M

black tex

1518.13.2M

bronce

1518.14

alu satin

1518.16.2M

satin gold

1518.23.2M

dark bronze

**built-up**

230V - spots to be ordered separately  
Strahler separat zu bestellen



8320/.. - STELLA

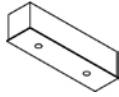

rectangular base for built-up spot or pendant  
rechteckige Basis für Aufbaustrahler oder Hängelampe

**Dimensions**

↔ L183xB48xH47

**Materials**

aluminium	14   1M   2M   45
brass	4   16

**Ref**

8320.1M	white tex
8320.2M	black tex
8320.4.2M	shiny gold
8320.14	alu satin
8320.16.2M	satin gold
8320.45	sun gold

*built-up  
spots to be ordered separately  
Spotlights separat zu bestellen*

8324/.. - STELLA

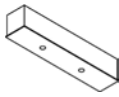

rectangular base for built-up spot or pendant  
rechteckige Basis für Aufbaustrahler oder Hängelampe

**Dimensions**

↔ L243xB48xH47

**Materials**

aluminium	14   1M   2M   45
brass	4   16

**Ref**

8324.1M	white tex
8324.2M	black tex
8324.4.2M	shiny gold
8324.14	alu satin
8324.16.2M	satin gold
8324.45	sun gold

*built-up  
spots to be ordered separately  
Spotlights separat zu bestellen*

8325/.. - STELLA

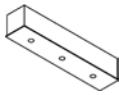

rectangular base for built-up spot or pendant  
rechteckige Basis für Aufbaustrahler oder Hängelampe

**Dimensions**

↔ L243xB48xH47

**Materials**

aluminium	14   1M   2M   45
brass	4   16

**Ref**

8325.1M	white tex
8325.2M	black tex
8325.4.2M	shiny gold
8325.14	alu satin
8325.16.2M	satin gold
8325.45	sun gold

*built-up  
spots to be ordered separately  
Spotlights separat zu bestellen*

1166.200/.. - JUBA - M10

~230V  IP20    0,3600 

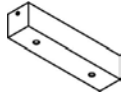

ceiling light without spotlight or pendant - 20 cm - with 2 holes - place for driver  
Deckenleuchte ohne Spot oder Hängelampe - 20 cm - mit 2 Öffnungen - Platz für den Driver

**Dimensions**  
L200xB40xH40





**Options**  
P039 - STRAIN RELIEF - TREKONTLASTING  
P040 - STRAIN RELIEF - TREKONTLASTING  
TR89800255 - DRIVER

**Materials**  
aluminium 1 | 2 | 11 | 14 | 1M | 2M  
brass 4 | 13 | 16 | 23

Ref	
1166.200.1	white
1166.200.1M	white tex
1166.200.2	black
1166.200.2M	black tex
1166.200.4	shiny gold
1166.200.11	alu grey
1166.200.13	bronze
1166.200.14	alu satin
1166.200.16	satin gold
1166.200.23	dark bronze

built-up

1166.320/.. - JUBA - M10

~230V  IP20    0,5400 

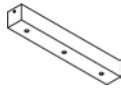

ceiling light without spotlight or pendant - 32cm - with 3 holes - place for driver  
Deckenleuchte ohne Spot oder Hängelampe - 32cm - mit 3 Öffnungen - Platz für den Driver

**Dimensions**  
L320xB40xH40

**Options**  
P039 - STRAIN RELIEF - TREKONTLASTING  
P040 - STRAIN RELIEF - TREKONTLASTING  
TR89800255 - DRIVER

**Materials**  
aluminium 1 | 2 | 11 | 14 | 1M | 2M  
brass 4 | 13 | 16 | 23

Ref	
1166.320.1	white
1166.320.1M	white tex
1166.320.2	black
1166.320.2M	black tex
1166.320.4	shiny gold
1166.320.11	alu grey
1166.320.13	bronze
1166.320.14	alu satin
1166.320.16	satin gold
1166.320.23	dark bronze

built-up

1166.400/.. - JUBA - M10

~230V  IP20    0,3000 

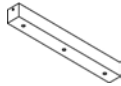

ceiling light without spotlight or pendant - 40cm - with 3 holes - place for driver  
Deckenleuchte ohne Spot oder Hängelampe - 40cm - mit 3 Öffnungen - Platz für den Driver

**Dimensions**  
L400xB40xH40

**Options**  
P039 - STRAIN RELIEF - TREKONTLASTING  
P040 - STRAIN RELIEF - TREKONTLASTING  
TR89800255 - DRIVER

**Materials**  
aluminium 1 | 2 | 11 | 14 | 1M | 2M  
brass 4 | 13 | 16 | 23

Ref	
1166.400.1	white
1166.400.1M	white tex
1166.400.2	black
1166.400.2M	black tex
1166.400.4	shiny gold
1166.400.11	alu grey
1166.400.13	bronze
1166.400.14	alu satin
1166.400.16	satin gold
1166.400.23	dark bronze

built-up





1162.200/.. - JUBA

~230V  IP20   

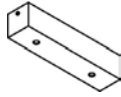

ceiling light without spotlight or pendant - 20 cm - with 2 holes - place for driver  
Deckenleuchte ohne Spot oder Hängelampe - 20 cm - mit 2 Öffnungen - Platz für den Driver

**Dimensions**  
L200xB45xH45

**Options**  
P039 - STRAIN RELIEF - TREKONTLASTING  
P040 - STRAIN RELIEF - TREKONTLASTING  
TR89800255 - DRIVER

**Materials**  
aluminium 1 | 2 | 11 | 14 | 1M | 2M  
brass 4 | 13 | 16 | 23

Ref	
1162.200.1	white
1162.200.1M	white tex
1162.200.2	black
1162.200.2M	black tex
1162.200.4	shiny gold
1162.200.11	alu grey
1162.200.13	bronze
1162.200.14	alu satin
1162.200.16	satin gold
1162.200.23	dark bronze

built-up

1162.320/.. - JUBA

~230V  IP20   

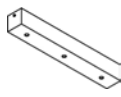

ceiling light without spotlight or pendant - 32cm - with 3 holes - place for driver  
Deckenleuchte ohne Spot oder Hängelampe - 32cm - mit 3 Öffnungen - Platz für den Driver

**Dimensions**  
L320xB45xH45

**Options**  
P039 - STRAIN RELIEF - TREKONTLASTING  
P040 - STRAIN RELIEF - TREKONTLASTING  
TR89800255 - DRIVER

**Materials**  
aluminium 1 | 2 | 11 | 14 | 1M | 2M  
brass 4 | 13 | 16 | 23

Ref	
1162.320.1	white
1162.320.1M	white tex
1162.320.2	black
1162.320.2M	black tex
1162.320.4	shiny gold
1162.320.11	alu grey
1162.320.13	bronze
1162.320.14	alu satin
1162.320.16	satin gold
1162.320.23	dark bronze

built-up

1162.400/.. - JUBA

~230V  IP20   

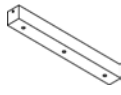

ceiling light without spotlight or pendant - 40cm - with 3 holes - place for driver  
Deckenleuchte ohne Spot oder Hängelampe - 40cm - mit 3 Öffnungen - Platz für den Driver

**Dimensions**  
L400xB45xH45

**Options**  
P039 - STRAIN RELIEF - TREKONTLASTING  
P040 - STRAIN RELIEF - TREKONTLASTING  
TR89800255 - DRIVER

**Materials**  
aluminium 1 | 2 | 11 | 14 | 1M | 2M  
brass 4 | 13 | 16 | 23

Ref	
1162.400.1	white
1162.400.1M	white tex
1162.400.2	black
1162.400.2M	black tex
1162.400.4	shiny gold
1162.400.11	alu grey
1162.400.13	bronze
1162.400.14	alu satin
1162.400.16	satin gold
1162.400.23	dark bronze

built-up

808.ZT/.. - JUBA ZT - M10

~230V



IP20

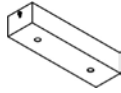

ceiling light without spotlight or pendant - 20cm - without transformer  
Deckenleuchte ohne Spot oder Hängelampe - 20cm - ohne Trafo

**Dimensions**

L200xB55xH40

**Options**

- 000B3 - JUBA supplement SWIVEL
- P039 - STRAIN RELIEF - TREKONTLASTING
- P040 - STRAIN RELIEF - TREKONTLASTING
- TR119772 - TRANSFO 0-70W
- TR89800255 - DRIVER

**Materials**

aluminium 1 | 2 | 11 | 14 | 1M | 2M  
brass 4 | 13 | 16 | 23

**Ref**

808.ZT.1	white
808.ZT.1M	white tex
808.ZT.2	black
808.ZT.2M	black tex
808.ZT.4	shiny gold
808.ZT.11	alu grey
808.ZT.13	bronze
808.ZT.14	alu satin
808.ZT.16	satin gold
808.ZT.23	dark bronze

built-up



807.ZT/.. - JUBA ZT - M10

~230V  IP20    0,3100 

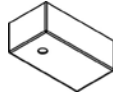

ceiling light without spotlight or pendant - 10cm - without transformer  
Deckenleuchte ohne Spot oder Hängelampe - 10cm - ohne Trafo

**Dimensions**  
L100xB55xH40

**Options**  
000B3 - JUBA supplement SWIVEL  
P039 - STRAIN RELIEF - TREKONTLASTING  
P040 - STRAIN RELIEF - TREKONTLASTING  
TR122790 - DRIVER

**Materials**  
aluminium 1 | 2 | 11 | 14 | 1M | 2M  
brass 4 | 13 | 16 | 23

Ref	
807.ZT.1	white
807.ZT.1M	white tex
807.ZT.2	black
807.ZT.2M	black tex
807.ZT.4	shiny gold
807.ZT.11	alu grey
807.ZT.13	bronze
807.ZT.14	alu satin
807.ZT.16	satin gold
807.ZT.23	dark bronze

built-up

809.ZT/.. - JUBA ZT - M10

~230V  IP20    0,6200 

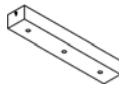

ceiling light without spotlight or pendant - 32cm - without transformers  
Deckenleuchte ohne Spot oder Hängelampe - 32cm - ohne Trafos

**Dimensions**  
L320xB55xH40

**Options**  
000B3 - JUBA supplement SWIVEL  
P039 - STRAIN RELIEF - TREKONTLASTING  
P040 - STRAIN RELIEF - TREKONTLASTING  
TR119772 - TRANSFO 0-70W

**Materials**  
aluminium 1 | 2 | 11 | 14 | 1M | 2M  
brass 4 | 13 | 16 | 23

Ref	
809.ZT.1	white
809.ZT.1M	white tex
809.ZT.2	black
809.ZT.2M	black tex
809.ZT.4	shiny gold
809.ZT.11	alu grey
809.ZT.13	bronze
809.ZT.14	alu satin
809.ZT.16	satin gold
809.ZT.23	dark bronze

built-up

817.ZT/.. - JUBA ZT - M10

~230V  IP20    1,4700 

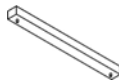

ceiling light without spotlight or pendant - 60cm- without transformers  
Deckenleuchte ohne Spot oder Hängelampe

**Dimensions**  
L600xB50xH40

**Options**  
000B3 - JUBA supplement SWIVEL  
000C - TREKONTLASTING PER PENDEL TEXTILE  
000CR - TREKONTLASTING PER PENDEL TEXTILE  
TR119772 - TRANSFO 0-70W  
TR89800255 - DRIVER

**Materials**  
aluminium 1 | 2 | 11 | 14 | 1M | 2M  
brass 4 | 13 | 16 | 23

Ref	
817.ZT.1	white
817.ZT.1M	white tex
817.ZT.2	black
817.ZT.2M	black tex
817.ZT.4	shiny gold
817.ZT.11	alu grey
817.ZT.13	bronze
817.ZT.14	alu satin
817.ZT.16	satin gold
817.ZT.23	dark bronze

built-up

818/.. - JUBA ZT

~230V  IP20   



ceiling light without spotlight or pendant  
Deckenleuchte ohne Spot oder Hängelampe

**Dimensions**  
↔ B50xH40

**Options**  
000B3 - JUBA supplement SWIVEL  
000C - TREKONTLASTING PER PENDEL TEXTILE  
000CR - TREKONTLASTING PER PENDEL TEXTILE  
TR119772 - TRANSFO 0-70W

**Materials**  
aluminium  
brass

1 | 2 | 11 | 14 | 1M | 2M | 46  
4 | 13 | 16 | 23

Colour	818.ZT/..	819.ZT/..
	H 900	H 1200
1		
1M		
2		
2M		
4		
11		
13		
14		
16		
23		
46		

**built-up**  
mention the number of holes!  
Zahl der Löcher erwähnen!

811/.. - JUBA ZT

~230V  IP20   

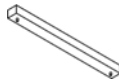

ceiling light without spotlight or pendant  
Deckenleuchte ohne Spot oder Hängelampe

**Dimensions**  
↔ B50xH40

**Options**  
000B3 - JUBA supplement SWIVEL  
000C - TREKONTLASTING PER PENDEL TEXTILE  
000CR - TREKONTLASTING PER PENDEL TEXTILE  
TR119772 - TRANSFO 0-70W

**Materials**  
aluminium  
brass

1 | 2 | 11 | 14 | 1M | 2M  
4 | 13 | 16 | 23

Colour	811.ZT/..	812.ZT/..	813.ZT/..
	H 1400	H 1500	H 1600
1			
1M			
2			
2M			
4			
11			
13			
14			
16			
23			

**built-up**  
mention the number of holes!  
Zahl der Löcher erwähnen!

814/.. - JUBA ZT

~230V



IP20



ceiling light without spotlight or pendant  
Deckenleuchte ohne Spot oder Hängelampe

**Materials**  
aluminium

1 | 2 | 11 | 14 | 1M | 2M | 53

**Dimensions**

↔ B45xH45

**Options**

- 000B3 - JUBA supplement SWIVEL
- 000C - TREKONTLASTING PER PENDEL TEXTILE
- 000CR - TREKONTLASTING PER PENDEL TEXTILE
- TR119772 - TRANSFO 0-70W

**built-up**

include drawing with the number of holes! - Extra  
transport cost - long profile  
Zeichnung mit Zahl der Löcher beifügen!

Colour	814.A.ZT/..	814.B.ZT/..	814.C.ZT/..	814.D.ZT/..	814.E.ZT/..	814.F.ZT/..
	H 1800	H 2000	H 2250	H 2500	H 2750	H 3000
1						
1M						
2						
2M						
11						
14						
53						





000B3/.. - JUBA supplement SWIVEL

IP20   0,0010 

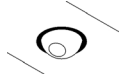
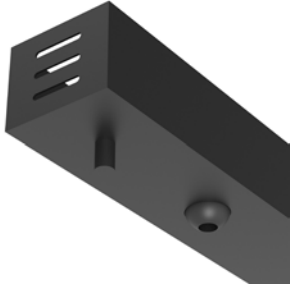

supplement - additional cost for drilling the holes for pendant with swivel  
 Supplement - zusätzliche Kosten für Ausbohrung Löcher für Pendelleuchte mit Kugelgelenk

Ref  
 000B3

000C/.. - TREKONTLASTING PER PENDEL TEXTILE

IP20   0,0600 

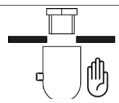
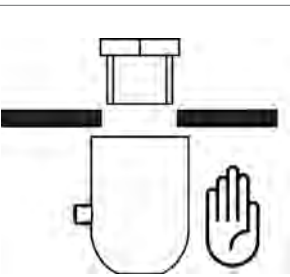

drawing holes + drilling + strain relief  
 Zeichnen Locher + Bohrung + Zugentlastung

Dimensions  
 $\varnothing 15 \times H21$

Materials  
 aluminium 11 | 14 | 1M | 21 | 2M | 46 | 53  
 brass 13 | 16 | 23

Ref  
 000C.1M white tex  
 000C.2M black tex  
 000C.11 alu grey  
 000C.13 bronze  
 000C.14 alu satin  
 000C.16 satin gold  
 000C.21 rust  
 000C.23 dark bronze  
 000C.46 grey-brown  
 000C.53 bronze-brown

000CR/.. - TREKONTLASTING PER PENDEL TEXTILE

IP20   0,0400 

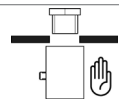
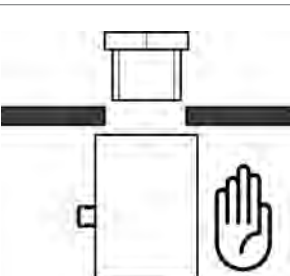

drawing holes + drilling + strain relief  
 Zeichnen Locher + Bohrung + Zugentlastung

Dimensions  
 $\varnothing 15 \times H21$

Materials  
 aluminium 1 | 2 | 11 | 14 | 1M | 21 | 2M | 44 | 46 | 53  
 brass 4 | 13 | 16 | 23

Ref  
 000CR.1 white  
 000CR.1M white tex  
 000CR.2 black  
 000CR.2M black tex  
 000CR.4 shiny gold  
 000CR.11 alu grey  
 000CR.13 bronze  
 000CR.14 alu satin  
 000CR.16 satin gold  
 000CR.21 rust  
 000CR.23 dark bronze  
 000CR.44 anthracite grey  
 000CR.46 grey-brown  
 000CR.53 bronze-brown

built-up







5021/.. - MAESTRO

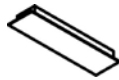

~230V   IP20    0,8500 



built-up

ceiling light - 30cm - without transformer  
Deckenleuchte - 30cm - ohne Trafo

**Dimensions**

 L300xB80xH32  
 L260xB60xH30

**Options**

000C - TREKONTLASTING PER PENDEL TEXTILE  
000CR - TREKONTLASTING PER PENDEL TEXTILE

**Materials**

aluminium 14 | 1M | 2M  
brass 4 | 13 | 16 | 23

**Ref**

5021.1M	white tex
5021.2M	black tex
5021.4	shiny gold
5021.4.2	shiny gold
5021.13	bronze
5021.13.2	bronze
5021.14	alu satin
5021.16	satin gold
5021.16.2	satin gold
5021.23	dark bronze
5021.23.2	dark bronze

5022/.. - MAESTRO



~230V   IP20    1,3000 



built-up

ceiling light - 60cm - without transformer  
Deckenleuchte - 60cm - ohne Trafo

**Dimensions**

 L600xB80xH32  
 L560xB60xH30

**Options**

000C - TREKONTLASTING PER PENDEL TEXTILE  
000CR - TREKONTLASTING PER PENDEL TEXTILE

**Materials**

aluminium 14 | 1M | 2M  
brass 4 | 13 | 16 | 23

**Ref**

5022.1M	white tex
5022.2M	black tex
5022.4	shiny gold
5022.4.2	shiny gold
5022.13	bronze
5022.13.2	bronze
5022.14	alu satin
5022.16	satin gold
5022.16.2	satin gold
5022.23	dark bronze
5022.23.2	dark bronze

5023/.. - MAESTRO



~230V   IP20    1,9100 



built-up

ceiling light - 90cm - without transformer  
Deckenleuchte - 90cm - ohne Trafo

**Dimensions**

 L900xB80xH32  
 L860xB60xH30

**Options**

000C - TREKONTLASTING PER PENDEL TEXTILE  
000CR - TREKONTLASTING PER PENDEL TEXTILE

**Materials**

aluminium 14 | 1M | 2M  
brass 4 | 13 | 16 | 23

**Ref**

5023.1M	white tex
5023.2M	black tex
5023.4	shiny gold
5023.4.2	shiny gold
5023.13	bronze
5023.13.2	bronze
5023.14	alu satin
5023.16	satin gold
5023.16.2	satin gold
5023.23	dark bronze
5023.23.2	dark bronze

5024/.. - MAESTRO

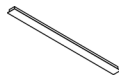

~230V   IP20    3,2000 



built-up

ceiling light - 120cm - without transformer  
Deckenleuchte - 120cm - ohne Trafo

**Dimensions**

 L1200xB80xH32  
 L1160xB60xH30

**Options**

000C - TREKONTLASTING PER PENDEL TEXTILE  
000CR - TREKONTLASTING PER PENDEL TEXTILE

**Materials**

aluminium 14 | 1M | 21 | 2M  
brass 4 | 13 | 16 | 23

**Ref**

5024.1M	white tex
5024.2M	black tex
5024.4	shiny gold
5024.4.2	shiny gold
5024.13	bronze
5024.13.2	bronze
5024.14	alu satin
5024.16	satin gold
5024.16.2	satin gold
5024.21	rust
5024.23	dark bronze
5024.23.2	dark bronze

5025/.. - MAESTRO

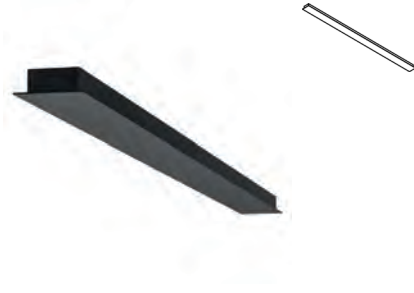

~230V   IP20    3,7000 



built-up

ceiling light - 140cm - without transformer  
Deckenleuchte - 140cm - ohne Trafo

**Dimensions**

 L1400xB80xH32  
 L1360xB60xH30

**Options**

000C - TREKONTLASTING PER PENDEL TEXTILE  
000CR - TREKONTLASTING PER PENDEL TEXTILE

**Materials**

aluminium 2 | 14 | 1M | 2M  
brass 4 | 13 | 16 | 23

**Ref**

5025.1M	white tex
5025.2	black
5025.2M	black tex
5025.4	shiny gold
5025.4.2	shiny gold
5025.13	bronze
5025.13.2	bronze
5025.14	alu satin
5025.16	satin gold
5025.16.2	satin gold
5025.23	dark bronze
5025.23.2	dark bronze





701.900/.. - TEXO

~230V  IP20    1,2000 



rectangular base for built-up spot or pendant  
rechteckige Basis für Aufbaustrahler oder Hängelampe

**Dimensions**

 L900xB120xH32  
 L860xB100xH40

**Options**

000C - TREKONTLASTING PER PENDEL TEXTILE  
000CR - TREKONTLASTING PER PENDEL TEXTILE

**Materials**





aluminium 1M | 2M

**Ref**

701.900.1M white tex  
701.900.2M black tex

built-up

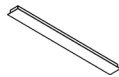

701.1200/.. - TEXO

~230V  IP20    4,5800 



rectangular base for built-up spot or pendant  
rechteckige Basis für Aufbaustrahler oder Hängelampe

**Dimensions**

 L1200xB120xH32  
 L1160xB100xH40

**Options**

000C - TREKONTLASTING PER PENDEL TEXTILE  
000CR - TREKONTLASTING PER PENDEL TEXTILE

**Materials**

aluminium 1M | 2M

**Ref**

701.1200.1M white tex  
701.1200.2M black tex

built-up



701.1600/.. - TEXO

~230V  IP20    5,4500 



rectangular base for built-up spot or pendant  
rechteckige Basis für Aufbaustrahler oder Hängelampe

**Dimensions**

 L1600xB120xH32  
 L1560xB100xH40

**Options**

000C - TREKONTLASTING PER PENDEL TEXTILE  
000CR - TREKONTLASTING PER PENDEL TEXTILE

**Materials**





aluminium 1M | 2M

**Ref**

701.1600.1M white tex  
701.1600.2M black tex

built-up

701.1800/.. - TEXO

~230V  IP20    5,8600 



rectangular base for built-up spot or pendant  
rechteckige Basis für Aufbaustrahler oder Hängelampe

**Dimensions**

 L1800xB120xH32  
 L1760xB100xH40

**Options**

000C - TREKONTLASTING PER PENDEL TEXTILE  
000CR - TREKONTLASTING PER PENDEL TEXTILE

**Materials**

aluminium 1M | 2M

**Ref cat (LONG)**

701.1800.1M white tex  
701.1800.2M black tex

built-up

extra transport cost - long profile  
Transportkostenzuschlag - langes Profil





702.1200x160/.. - TEXO

~230V  IP20    



rectangular base for built-up spot or pendant  
rechteckige Basis für Aufbaustrahler oder Hängelampe

**Dimensions**

 L1200xB160xH30  
 L1160xB140xH28

**Options**

000C - TREKONTLASTING PER PENDEL TEXTILE  
000CR - TREKONTLASTING PER PENDEL TEXTILE

**Materials**

aluminium 1M | 2M | 44 | 46

**Ref**

702.1200x160.1M	white tex
702.1200x160.2M	black tex
702.1200x160.44	anthracite grey
702.1200x160.46	grey-brown

built-up

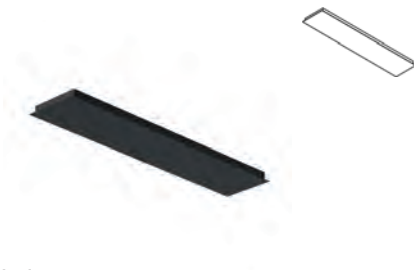

703.1200x250/.. - TEXO

~230V  IP20  



rectangular base for built-up spot or pendant  
rechteckige Basis für Aufbaustrahler oder Hängelampe

**Dimensions**

 L1200xB250xH30  
 L1160xB246xH28

**Options**

000C - TREKONTLASTING PER PENDEL TEXTILE  
000CR - TREKONTLASTING PER PENDEL TEXTILE

**Materials**

aluminium 1M | 2M

**Ref**

703.1200x250.1M	white tex
703.1200x250.2M	black tex

built-up



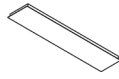

704.800X300/.. - TEXO

~230V  IP20    6,8000 



ceiling light - rectangular base for built-up spot or pendant  
Deckenleuchte - rechteckige Basis für Aufbaustrahler oder Hängelampe

**Dimensions**

 L800xB300xH30  
 L760xB280xH28

**Options**

000C - TREKONTLASTING PER PENDEL TEXTILE  
000CR - TREKONTLASTING PER PENDEL TEXTILE

**Materials**

aluminium 1M | 2M

**Ref**

704.800X300.1M white tex  
704.800X300.2M black tex

*built-up*  
230V - spots to be ordered separately  
Strahler separat zu bestellen

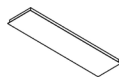

704.1200X300/.. - TEXO

~230V  IP  9,4800 



rectangular base for built-up spot or pendant  
rechteckige Basis für Aufbaustrahler oder Hängelampe

**Dimensions**

 L1200xB300xH30  
 L1160xB280

**Options**

000C - TREKONTLASTING PER PENDEL TEXTILE  
000CR - TREKONTLASTING PER PENDEL TEXTILE

**Materials**

aluminium 1M | 2M

**Ref**

704.1200X300.1M white tex  
704.1200X300.2M black tex

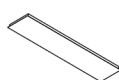

704.1400X300/.. - TEXO

~230V  IP  10,8200 



rectangular base for built-up spot or pendant  
rechteckige Basis für Aufbaustrahler oder Hängelampe

**Dimensions**

 L1400xB300xH30  
 L1360xB280xH28

**Options**

000C - TREKONTLASTING PER PENDEL TEXTILE  
000CR - TREKONTLASTING PER PENDEL TEXTILE

**Materials**

aluminium 1M | 2M

**Ref**

704.1400X300.1M white tex  
704.1400X300.2M black tex

705.1200X500/.. - TEXO

~230V  IP20   13,0000 



rectangular base for built-up spot or pendant  
rechteckige Basis für Aufbaustrahler oder Hängelampe

**Dimensions**

 L1170xB470xH28

**Options**

000C - TREKONTLASTING PER PENDEL TEXTILE  
000CR - TREKONTLASTING PER PENDEL TEXTILE

**Materials**

aluminium 1M | 2M

**Ref**

705.1200X500.1M white tex  
705.1200X500.2M black tex

*built-up*

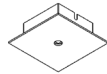

651/.. - TEXO - M10

~230V  IP20    0,2810 



built-up base - square - no room for transformer  
Aufbaurosette - viereckig - kein Platz für Trafo

**Dimensions**

 L85xB85xH30  
 L60xB60

**Options**

P039 - STRAIN RELIEF - TREKONTLASTING  
P040 - STRAIN RELIEF - TREKONTLASTING

**Materials**

aluminium 1 | 2 | 11 | 14 | 1M | 2M  
brass 4 | 13 | 16

**Ref**

651.1 white  
651.1M white tex  
651.2 black  
651.2M black tex  
651.4 shiny gold  
651.11 alu grey  
651.13 bronze  
651.14 alu satin  
651.16 satin gold

*built-up*  
230V - spot to be ordered separately  
Strahler separat zu bestellen

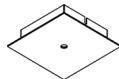

650/.. - TEXO - M10

~230V  IP20   



built-up base - square - no room for transformer  
Aufbaurosette - viereckig - kein Platz für Trafo

**Dimensions**

 L130xB130xH30  
 L100xB100

**Options**

P039 - STRAIN RELIEF - TREKONTLASTING  
P040 - STRAIN RELIEF - TREKONTLASTING

**Materials**



aluminium 1 | 2 | 11 | 14 | 1M | 2M  
brass 4 | 13 | 16  
INOX 316 5

**Ref**

650.1 white  
650.1M white tex  
650.2 black  
650.2M black tex  
650.4 shiny gold  
650.5 inox 316  
650.11 alu grey  
650.13 bronze  
650.14 alu satin  
650.16 satin gold

*built-up*  
230V - spot to be ordered separately  
Strahler separat zu bestellen

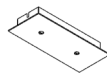

652/.. - TEXO - M10

~230V  IP20    0,7800 



ceiling light - no room for transformer  
Deckenleuchte - kein Platz für Trafo

**Dimensions**

 L200xB85xH30  
 L175xB60

**Options**

P039 - STRAIN RELIEF - TREKONTLASTING  
P040 - STRAIN RELIEF - TREKONTLASTING

**Materials**





aluminium 1 | 2 | 11 | 14 | 1M | 2M | 11M  
brass 4 | 13 | 16 | 23

**Ref**

652.1 white  
652.1M white tex  
652.2 black  
652.2M black tex  
652.4 shiny gold  
652.11 alu grey  
652.11M grey tex  
652.13 bronze  
652.14 alu satin  
652.16 satin gold  
652.23 dark bronze

*built-up*  
230V - spots to be ordered separately  
Strahler separat zu bestellen

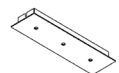

653/.. - TEXO - M10

~230V  IP20    1,1400 



ceiling light - no room for transformer  
Deckenleuchte - kein Platz für Trafo

**Dimensions**

 L300xB85xH30  
 L275xB60

**Options**

P039 - STRAIN RELIEF - TREKONTLASTING  
P040 - STRAIN RELIEF - TREKONTLASTING

**Materials**

aluminium 1 | 2 | 11 | 14 | 1M | 2M  
brass 4 | 13 | 16 | 23

**Ref**

653.1 white  
653.1M white tex  
653.2 black  
653.2M black tex  
653.4 shiny gold  
653.11 alu grey  
653.13 bronze  
653.14 alu satin  
653.16 satin gold  
653.23 dark bronze

*built-up*  
230V - spots to be ordered separately  
Strahler separat zu bestellen

654/.. - TEXO - M10

~230V



IP20



1.3130

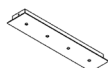

ceiling light - no room for transformer  
Deckenleuchte - kein Platz für Trafo

**Dimensions**

L400xB85xH30

L375xB60

**Options**

P039 - STRAIN RELIEF - TREKONTLASTING

P040 - STRAIN RELIEF - TREKONTLASTING

**Materials**

aluminium

1 | 2 | 11 | 14 | 1M | 2M

brass

4 | 13 | 16

**Ref**

654.1

white

654.1M

white tex

654.2

black

654.2M

black tex

654.4

shiny gold

654.11

alu grey

654.13

bronze

654.14

alu satin

654.16

satin gold

**built-up**

230V - spots to be ordered separately  
Strahler separat zu bestellen



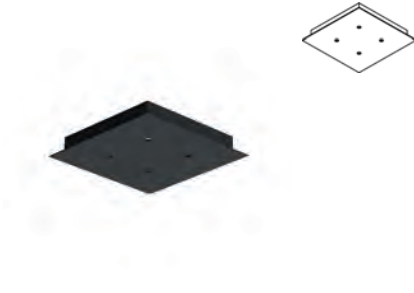

655/.. - TEXO - M10

~230V  IP20    1,8400 



ceiling light - no room for transformer - square base  
Deckenleuchte - kein Platz für Trafo - viereckige Basis

**Dimensions**

 L215xB215xH30  
 L185xB185

**Options**

P039 - STRAIN RELIEF - TREKONTLASTING  
P040 - STRAIN RELIEF - TREKONTLASTING

**Materials**

aluminium 1 | 2 | 11 | 14 | 1M | 2M  
brass 4 | 13 | 16

**Ref**

655.1	white
655.1M	white tex
655.2	black
655.2M	black tex
655.4	shiny gold
655.11	alu grey
655.13	bronze
655.14	alu satin
655.16	satin gold

**built-up**  
230V - spots to be ordered separately  
Strahler separat zu bestellen

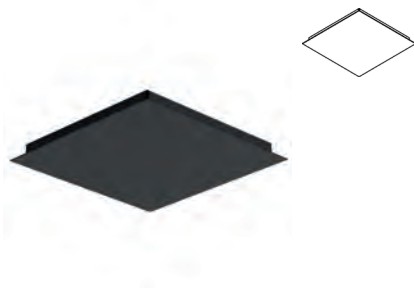

656/.. - TEXO - M10

~230V  IP20    2,1800 



ceiling light - square base 300x300mm  
Deckenleuchte - viereckige Basis 300x300mm

**Dimensions**

 L300xB300xH30  
 L270xB270

**Options**

000C - TREKONTLASTING PER PENDEL TEXTILE  
000CR - TREKONTLASTING PER PENDEL TEXTILE

**Materials**

aluminium 14 | 1M | 2M

**Ref**

656.1M	white tex
656.2M	black tex
656.14.2M	alu satin
656.14.11	alu satin

**built-up**  
230V - spots to be ordered separately  
Strahler separat zu bestellen

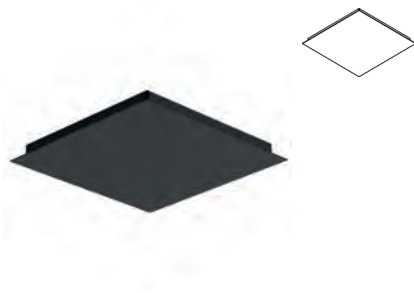

657/.. - TEXO - M10

~230V  IP20    2,8500 



ceiling light - square base 350x350mm  
Deckenleuchte - viereckige Basis 350x350mm

**Dimensions**

 L350xB350xH30  
 L320xB320

**Options**

000C - TREKONTLASTING PER PENDEL TEXTILE  
000CR - TREKONTLASTING PER PENDEL TEXTILE

**Materials**

aluminium 14 | 1M | 2M

**Ref**

657.1M	white tex
657.2M	black tex
657.14.2M	alu satin
657.14.11	alu satin

**built-up**  
230V - spots to be ordered separately  
Strahler separat zu bestellen



658/.. - TEXO - M10

~230V  IP20    3,9600 



ceiling light - square base 400x400mm  
Deckenleuchte - viereckige Basis 400x400mm

**Dimensions**

 L400xB400xH30  
 L370xB370

**Options**

000C - TREKONTLASTING PER PENDEL TEXTILE  
000CR - TREKONTLASTING PER PENDEL TEXTILE

**Materials**

aluminium 14 | 1M | 2M

**Ref**

658.1M	white tex
658.2M	black tex
658.14.2M	alu satin
658.14.11	alu satin

**built-up**  
230V - spots to be ordered separately  
Strahler separat zu bestellen



659/.. - TEXO - M10

~230V  IP20    6,0400 

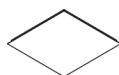

ceiling light - square base 500x500mm  
Deckenleuchte - viereckige Basis 500x500mm

**Dimensions**

↔ L500xB500xH30  
↘ L470xB470

**Options**

000C - TREKONTLASTING PER PENDEL TEXTILE  
000CR - TREKONTLASTING PER PENDEL TEXTILE

**Materials**





aluminium 14 | 1M | 2M

**Ref**

659.1M	white tex
659.2M	black tex
659.14.2M	alu satin
659.14.11	alu satin

**built-up**  
230V - spots to be ordered separately  
Strahler separat zu bestellen

700/.. - TEXO - M10

~230V  IP20    9,0500 

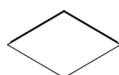

ceiling light - square base 600x600mm  
Deckenleuchte - viereckige Basis 600x600mm

**Dimensions**

↔ L600xB600xH30  
↘ L570xB570

**Options**

000C - TREKONTLASTING PER PENDEL TEXTILE  
000CR - TREKONTLASTING PER PENDEL TEXTILE

**Materials**

aluminium 14 | 1M | 2M

**Ref**

700.1M	white tex
700.2M	black tex
700.14.2M	alu satin
700.14.11	alu satin

**built-up**  
230V - spots to be ordered separately  
Strahler separat zu bestellen





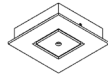

932.220/.. - SQUARE 230V - M10

~230V   IP20    0,9300 



ceiling light - spot to be ordered separately - without transformer  
Deckenleuchte - Strahler separat zu bestellen - ohne Trafo

**Dimensions**

 L125xB125xH33  
 L110xB110

**Materials**

aluminium 1 | 11 | 14 | 1M | 2M  
brass 16

**Ref**

932.220.1.1	white
932.220.1M.1M	white tex
932.220.2M.1M	black tex
932.220.11.11	alu grey
932.220.14.2	alu satin
932.220.14.11	alu satin
932.220.16.2	satin gold
932.220.16.16	satin gold

built-up



934.220/.. - SQUARE 230V - M10

~230V   IP20    1,5080 



ceiling light - spots to be ordered separately - without transformer  
Deckenleuchte - Strahler separat zu bestellen - ohne Trafo

**Dimensions**

 L170xB170xH29-42  
 L145xB145

**Materials**

aluminium 1 | 11 | 14 | 1M | 2M  
brass 16

**Ref**

934.220.1.1	white
934.220.1M.1M	white tex
934.220.2M.1M	black tex
934.220.11.11	alu grey
934.220.14.2	alu satin
934.220.14.11	alu satin
934.220.16.2	satin gold
934.220.16.16	satin gold

built-up

16 matt gold = height 42  
16 Mattgold = Höhe 42

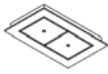

936.220/.. - SQUARE 230V - M10

~230V   IP20    2,3900 



ceiling light - spots to be ordered separately - without transformer  
Deckenleuchte - Strahler separat zu bestellen - ohne Trafo

**Dimensions**

 L275xB170xH29-42  
 L250xB145

**Materials**

aluminium 1 | 11 | 14 | 1M | 2M  
brass 16

**Ref**

936.220.1.1	white
936.220.1M.1M	white tex
936.220.2M.2M	black tex
936.220.11.11	alu grey
936.220.14.2	alu satin
936.220.14.11	alu satin
936.220.16.2	satin gold
936.220.16.16	satin gold

built-up

16 matt gold = height 42  
16 Mattgold = Höhe 42



938.220/.. - SQUARE 230V - M10

~230V   IP20    2,3900 



ceiling light - spots to be ordered separately - without transformer  
Deckenleuchte - Strahler separat zu bestellen - ohne Trafo

**Dimensions**

 L275xB170xH29-42  
 L250xB145

**Materials**

aluminium 1 | 11 | 14 | 1M | 2M  
brass 16

**Ref**

938.220.1.1	white
938.220.1M.1M	white tex
938.220.2M.1M	black tex
938.220.11.11	alu grey
938.220.14.2	alu satin
938.220.14.11	alu satin
938.220.16.2	satin gold
938.220.16.16	satin gold

built-up

16 matt gold = height 42  
16 Mattgold = Höhe 42



940.220/.. - SQUARE 230V - M10

~230V  IP20    3,3330 



ceiling light - spots to be ordered separately  
Deckenleuchte - Strahler separat zu bestellen

**Dimensions**

 L380xB170xH29-42  
 L355xB145

**Materials**

aluminium 1 | 11 | 14 | 1M | 2M  
brass 16

**Ref**

940.220.1.1	white
940.220.1M.1M	white tex
940.220.2M.1M	black tex
940.220.11.11	alu grey
940.220.14.2	alu satin
940.220.14.11	alu satin
940.220.16.2	satin gold
940.220.16.16	satin gold

**built-up**  
16 matt gold = height 42  
16 Mattgold = Höhe 42



942.220/.. - SQUARE 230V - M10

~230V  IP20    3,3300 



ceiling light - spots to be ordered separately  
Deckenleuchte - Strahler separat zu bestellen

**Dimensions**

 L380xB170xH29-42  
 L355xB145

**Materials**

aluminium 1 | 11 | 14 | 1M | 2M  
brass 16

**Ref**

942.220.1.1	white
942.220.1M.1M	white tex
942.220.2M.1M	black tex
942.220.11.11	alu grey
942.220.14.2	alu satin
942.220.14.11	alu satin
942.220.16.2	satin gold
942.220.16.16	satin gold

**built-up**  
16 matt gold = height 42  
16 Mattgold = Höhe 42



944.220/.. - SQUARE 230V - M10

~230V  IP20    3,8220 



ceiling light - spots to be ordered separately  
Deckenleuchte - Strahler separat zu bestellen

**Dimensions**

 L275xB275xH29-42  
 L250xB250

**Materials**

aluminium 1 | 11 | 14 | 1M | 2M  
brass 16

**Ref**

944.220.1.1	white
944.220.1M.1M	white tex
944.220.2M.2M	black tex
944.220.11.11	alu grey
944.220.14.2	alu satin
944.220.14.11	alu satin
944.220.16.2	satin gold

**built-up**  
16 matt gold = height 42  
16 Mattgold = Höhe 42



752.220/.. - SQUARE 230V - M10

~230V  IP20    3,2100 



ceiling light - spots to be ordered separately  
Deckenleuchte - Strahler separat zu bestellen

**Dimensions**

 L485xB170xH29-42  
 L460xB144

**Materials**

aluminium 1 | 11 | 14 | 1M | 2M  
brass 16

**Ref**

752.220.1.1	white
752.220.1M.1M	white tex
752.220.2M.1M	black tex
752.220.11.11	alu grey
752.220.14.2	alu satin
752.220.14.11	alu satin
752.220.16.2	satin gold

**built-up**  
16 matt gold = height 42  
16 Mattgold = Höhe 42



753.220/.. - SQUARE 230V - M10

~230V IP20 2.7750 CE



ceiling light - spots to be ordered separately  
Deckenleuchte - Strahler separat zu bestellen

**Dimensions**

L485xB170xH29-42

L460xB144

**Materials**

aluminium

1 | 11 | 14 | 1M | 2M

brass

16

**Ref**

753.220.1.1	white
753.220.1M.1M	white tex
753.220.2M.1M	black tex
753.220.11.11	alu grey
753.220.14.2	alu satin
753.220.14.11	alu satin
753.220.16.2	satin gold

**built-up**  
16 matt gold = height 42  
16 Mattgold = Höhe 42









1976/.. - LUXOR UP - M10

230V    IP20   



built-up base for spot - without transformer - without LED driver  
 Aufbaubase für Aufbaustrahler - ohne Trafo - ohne Driver LED

**Dimensions**

 L160xB160xH45  
 L140xB126

**Materials**

aluminium 1M | 2M

Ref	
1976.1M.1M	white tex
1976.1M.2M	white tex
1976.2M.2M	black tex
1976.2M.14	black tex

**built-up**  
 with closed cover plate - 1 spotlight to order separately  
 mit geschlossener Abdeckplatte - 1 Strahler separat bestellen

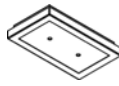

1977/.. - LUXOR UP - M10

230V    IP20   



built-up base for spot - without transformer - without LED driver  
 Aufbaubase für Aufbaustrahler - ohne Trafo - ohne Driver LED

**Dimensions**

 L302xB159xH45  
 L279xB126

**Materials**

aluminium 1M | 2M

Ref	
1977.1M.1M	white tex
1977.1M.2M	white tex
1977.2M.2M	black tex
1977.2M.14	black tex

**built-up**  
 with closed cover plate - 2 spotlights to order separately  
 mit geschlossener Abdeckplatte - 2 Strahler separat bestellen

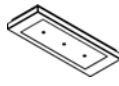

1978/.. - LUXOR UP - M10

230V    IP20   



built-up base for spot - spots to be ordered separately - without transformer - without LED driver  
 Aufbaubase für Aufbaustrahler - Strahler separat zu bestellen - ohne Trafo - ohne Driver LED

**Dimensions**

 L405xB159xH45  
 L382xB126







**Materials**

aluminium 1M | 2M

Ref	
1978.1M.1M	white tex
1978.1M.2M	white tex
1978.2M.2M	black tex
1978.2M.14	black tex

**built-up**  
 with closed cover plate - 3 spotlights to order separately  
 mit geschlossener Abdeckplatte - 3 Strahler separat bestellen

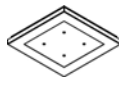

1979/.. - LUXOR UP - M10

230V    IP20    3,0700 



built-up base for spot - spots to be ordered separately - without transformer - without LED driver  
 Aufbaubase für Aufbaustrahler - Strahler separat zu bestellen - ohne Trafo - ohne Driver LED

**Dimensions**

 L340xB340xH45  
 L317xB317

**Materials**

aluminium 1M | 2M

Ref	
1979.1M.1M	white tex
1979.1M.2M	white tex
1979.2M.2M	black tex
1979.2M.14	black tex

**built-up**  
 with closed cover plate - 4 spotlights to order separately  
 mit geschlossener Abdeckplatte - 4 Strahler separat bestellen







856/.. - ZOOM - M10

230V  IP20    0,2440 



ceiling light - spot to be ordered separately  
Deckenleuchte - Strahler separat zu bestellen

**Dimensions**

 L89,5xB89,5xH22  
 L70xB70

**Materials**

aluminium 1 | 40  
brass 4 | 16

**Ref**

856.1	white
856.4	shiny gold
856.16	satin gold
856.40	anodised alu

built-up



858ZT/.. - ZOOM - M10

~230V  IP20    0,4760 



ceiling light - spot to be ordered separately  
Deckenleuchte - Strahler separat zu bestellen

**Dimensions**

 L89,5xB89,5xH45  
 L70xB70

**Materials**

aluminium 1 | 40  
brass 4 | 16

**Ref**

858ZT.1	white
858ZT.4	shiny gold
858ZT.16	satin gold
858ZT.40	anodised alu

built-up



860ZT/.. - ZOOM - M10

230V  S1 IP20    0,2770 



ceiling light - spot to be ordered separately  
Deckenleuchte - Strahler separat zu bestellen

**Dimensions**

 L89,5xB89,5xH55  
 72x72  75

**Materials**





aluminium 1 | 40  
brass 4 | 16

**Ref**

860ZT.1	white
860ZT.4	shiny gold
860ZT.16	satin gold
860ZT.40	anodised alu

semi built-in/up



896.A.ZT/.. - ZOOM BOX - M10

~230V  IP20    0,7960 



ceiling light - spots to be ordered separately  
Deckenleuchte - Strahler separat zu bestellen

**Dimensions**

 L150xB150xH50  
 L125xB125

**Materials**



aluminium 1 | 40  
brass 4 | 16

**Ref**

896.A.ZT.1	white
896.A.ZT.4	shiny gold
896.A.ZT.16	satin gold
896.A.ZT.40	anodised alu

built-up

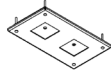

897.A.ZT/.. - ZOOM - M10

~230V  IP20    1,5300 



ceiling light - spots to be ordered separately  
Deckenleuchte - Strahler separat zu bestellen

**Dimensions**

 L285xB163xH50  
 L260xB138

**Materials**





aluminium	1   11   40
brass	4   16

**Ref**

897.A.ZT.1	white
897.A.ZT.4	shiny gold
897.A.ZT.11	alu grey
897.A.ZT.16	satin gold
897.A.ZT.40	anodised alu

built-up

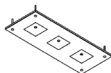

898.A.ZT/.. - ZOOM - M10

~230V  IP20    2,5000 



ceiling light - spots to be ordered separately  
Deckenleuchte - Strahler separat zu bestellen

**Dimensions**

 L410xB163xH50  
 L383xB138

**Materials**

aluminium	1   40
brass	4   16

**Ref**

898.A.ZT.1	white
898.A.ZT.4	shiny gold
898.A.ZT.16	satin gold
898.A.ZT.40	anodised alu

built-up

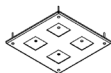

899.A.ZT/.. - ZOOM - M10

~230V  IP20    2,7500 



ceiling light - spots to be ordered separately  
Deckenleuchte - Strahler separat zu bestellen

**Dimensions**

 L285xB285xH50  
 L262xB262

**Materials**





aluminium	1   40
brass	4   16

**Ref**

899.A.ZT.1	white
899.A.ZT.4	shiny gold
899.A.ZT.16	satin gold
899.A.ZT.40	anodised alu

built-up

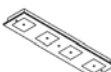

900.A.ZT/.. - ZOOM - M10

230V  IP20    2,8300 



ceiling light - spots to be ordered separately  
Deckenleuchte - Strahler separat zu bestellen

**Dimensions**

 L650xB160xH50  
 L620xB120

**Materials**

aluminium	1   40
brass	4   16

**Ref**

900.A.ZT.1	white
900.A.ZT.4	shiny gold
900.A.ZT.16	satin gold
900.A.ZT.40	anodised alu

built-up



901.A/.. - ZOOM - M10

~230V



IP20

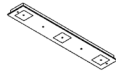
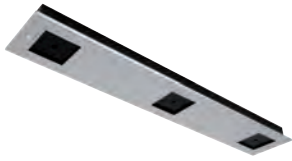

ceiling light - spots to be ordered separately  
Deckenleuchte - Strahler separat zu bestellen

Dimensions

L900xB160xH50

L870xB120

Materials

aluminium

brass

1 | 40

4 | 16

Ref

901.A.1

901.A.4

901.A.16

901.A.40

white

shiny gold

satin gold

anodised alu

built-up



**044.350MA/.. - BASIS VOOR OPBOUWSPOT - M10**

~230V   IP20   



rectangular base for built-up spot - with LED driver  
rechteckige Basis für Aufbaustrahler - mit Driver LED

**Dimensions**

↔ L110xB60xH38

**Materials**

aluminium 1M | 2M

**Ref**

044.350MA.1M white tex  
044.350MA.2M black tex

**built-up**

10W 350mA - dimmable with leading and trailing edge | other drivers possible on request  
10W 350mA - dimmbar mit einem Phasen- und Abschnitt | andere Transfos möglich auf Anfrage

**044.500MA/.. - BASIS VOOR OPBOUWSPOT - M10**

~230V   IP20   



rectangular base for built-up spot - with LED driver  
rechteckige Basis für Aufbaustrahler - mit Driver LED

**Dimensions**

↔ L110xB60xH38

**Materials**

aluminium 1M | 2M





**Ref**

044.500MA.1M white tex  
044.500MA.2M black tex

**built-up**

10W 500mA - dimmable with leading and trailing edge dimmer | other drivers possible on request  
10W 500mA - dimmbar mit einem Phasen- und Abschnitt | andere Transfos möglich auf Anfrage

**044.700MA/.. - BASIS VOOR OPBOUWSPOT - M10**

~230V   IP20   



rectangular base for built-up spot - with LED driver  
rechteckige Basis für Aufbaustrahler - mit Driver LED

**Dimensions**

↔ L110xB60xH38

**Materials**

aluminium 1M | 2M



**Ref**

044.700MA.1M white tex  
044.700MA.2M black tex

**built-up**

10W 700mA - dimmable with leading and trailing edge dimmer | other drivers possible on request  
10W 700mA - dimmbar Phasen- und Abschnitt | andere Transfos möglich auf Anfrage

**045.350MA/.. - BASIS VOOR OPBOUWSPOT - M10**

~230V   IP20   



rectangular base for built-up spot - with LED driver  
rechteckige Basis für Aufbaustrahler - mit Driver LED



**Dimensions**  
L179xB54xH38

**Materials**  
aluminium 1M | 2M

**Ref**  
045.350MA.1M white tex  
045.350MA.2M black tex

**built-up**  
17W 350mA - dimmable trailing edge  
17W 350mA - dimmbar Phasenabschnitt

**045.500MA/.. - BASIS VOOR OPBOUWSPOT - M10**

~230V   IP20   



rectangular base for built-up spot - with LED driver  
rechteckige Basis für Aufbaustrahler - mit Driver LED

**Dimensions**  
L179xB54xH38

**Materials**  
aluminium 1M | 2M

**Ref**  
045.500MA.1M white tex  
045.500MA.2M black tex

**built-up**  
20W 500mA - dimmable trailing edge  
20W 500mA - dimmbar Phasenabschnitt

**045.700MA/.. - BASIS VOOR OPBOUWSPOT - M10**

~230V   IP20   



rectangular base for built-up spot - with LED driver  
rechteckige Basis für Aufbaustrahler - mit Driver LED

**Dimensions**  
L179xB54xH38

**Materials**  
aluminium 1M | 2M

**Ref**  
045.700MA.1M white tex  
045.700MA.2M black tex

**built-up**  
17W 700mA - dimmable trailing edge  
dimmbar Phasenabschnitt

**045.1050MA/.. - BASIS VOOR OPBOUWSPOT - M10**

~230V   IP20    



rectangular base for built-up spot - with LED driver  
rechteckige Basis für Aufbaustrahler - mit Driver LED





**Dimensions**  
L179xB54xH38

**Materials**  
aluminium 1M | 2M

**Ref**  
045.1050MA.1M white tex  
045.1050MA.2M black tex

**built-up**  
22W 1050mA - dimmable on demand  
22W 1050mA - dimmbar auf Anfrage

**046.350MA/.. - BASIS VOOR OPBOUWSPOT - M10**

~230V   IP20   



rectangular base for built-up spot - with LED driver  
rechteckige Basis für Aufbaustrahler - mit Driver LED

**Dimensions**

↔ L179xB64xH38

**Materials**





aluminium 1M | 2M

**Ref**

046.350MA.1M white tex  
046.350MA.2M black tex

**built-up**  
17W 350mA - dimmable - LC  
17W 350mA - dimmbar - LC

**046.500MA/.. - BASIS VOOR OPBOUWSPOT - M10**

~230V   IP20   



rectangular base for built-up spot - with LED driver  
rechteckige Basis für Aufbaustrahler - mit Driver LED

**Dimensions**

↔ L179xB64xH38

**Materials**





aluminium 1M | 2M

**Ref**

046.500MA.1M white tex  
046.500MA.2M black tex

**built-up**  
20W 500mA - dimmable - LC  
20W 500mA - dimmbar - LC

**046.700MA/.. - BASIS VOOR OPBOUWSPOT - M10**

~230V   IP20   



rectangular base for built-up spot - with LED driver  
rechteckige Basis für Aufbaustrahler - mit Driver LED

**Dimensions**

↔ L179xB64xH38

**Materials**

aluminium 1M | 2M

**Ref**

046.700MA.1M white tex  
046.700MA.2M black tex

**built-up**  
20W 700mA - dimmable - push 1-10V  
20W 700mA - dimmbar - push 1-10V

**047.350MA/.. - BASIS VOOR OPBOUWSPOT - M10**

~230V   IP20   



rectangular base for built-up spot - with LED driver  
rechteckige Basis für Aufbaustrahler - mit Driver LED

**Dimensions**  
L179xB94xH38

**Materials**  
aluminium 1M | 2M

**Ref**  
047.350MA.1M white tex  
047.350MA.2M black tex

**built-up**  
25W 350mA - not dimmable  
25W 350mA - nicht dimmbar

**047.500MA/.. - BASIS VOOR OPBOUWSPOT - M10**

~230V   IP20   



rectangular base for built-up spot - with LED driver  
rechteckige Basis für Aufbaustrahler - mit Driver LED

**Dimensions**  
L179xB94xH38

**Materials**  
aluminium 1M | 2M

**Ref**  
047.500MA.1M white tex  
047.500MA.2M black tex

**built-up**  
35W 500mA - not dimmable  
35W 500mA - nicht dimmbar

**047.700MA/.. - BASIS VOOR OPBOUWSPOT - M10**

~230V   IP20   



rectangular base for built-up spot - with LED driver  
rechteckige Basis für Aufbaustrahler - mit Driver LED





**Dimensions**  
L179xB94xH38

**Materials**  
aluminium 1M | 2M

**Ref**  
047.700MA.1M white tex  
047.700MA.2M black tex

**built-up**  
50W 700mA - not dimmable  
50W 700mA - nicht dimmbar

**047.1050MA/.. - BASIS VOOR OPBOUWSPOT - M10**

~230V   IP20   



rectangular base for built-up spot - with LED driver  
rechteckige Basis für Aufbaustrahler - mit Driver LED

**Dimensions**  
L179xB94xH38





**Materials**  
aluminium 1M | 2M

**Ref**  
047.1050MA.1M white tex  
047.1050MA.2M black tex

**built-up**  
50W 1050mA - not dimmable  
50W 1050mA - nicht dimmbar



**048.350MA/.. - BASIS VOOR OPBOUWSPOT - M10**

~230V   IP20   



rectangular base for built-up spot - with LED driver  
rechteckige Basis für Aufbaustrahler - mit Driver LED





**Dimensions**  
L179xB94xH38

**Materials**  
aluminium 1M | 2M

**Ref**  
048.350MA.1M white tex  
048.350MA.2M black tex

**built-up**  
25W 350mA - dimmable - push 1-10V  
25W 350mA - dimmbar - push 1-10V

**048.500MA/.. - BASIS VOOR OPBOUWSPOT - M10**

~230V   IP20   



rectangular base for built-up spot - with LED driver  
rechteckige Basis für Aufbaustrahler - mit Driver LED





**Dimensions**  
L179xB94xH38

**Materials**  
aluminium 1M | 2M

**Ref**  
048.500MA.1M white tex  
048.500MA.2M black tex

**built-up**  
35W 500mA - dimmable - push 1-10V  
35W 500mA - dimmbar - push 1-10V

**048.700MA/.. - BASIS VOOR OPBOUWSPOT - M10**

~230V   IP20   



rectangular base for built-up spot - with LED driver  
rechteckige Basis für Aufbaustrahler - mit Driver LED





**Dimensions**  
L179xB94xH38

**Materials**  
aluminium 1M | 2M

**Ref**  
048.700MA.1M white tex  
048.700MA.2M black tex

**built-up**  
50W 700mA - dimmable - push 1-10V  
50W 700mA - dimmbar - push 1-10V

**048.1050MA/.. - BASIS VOOR OPBOUWSPOT - M10**

~230V   IP20   



rectangular base for built-up spot - with LED driver  
rechteckige Basis für Aufbaustrahler - mit Driver LED

**Dimensions**  
L179xB94xH38

**Materials**  
aluminium 1M | 2M

**Ref**  
048.1050MA.1M white tex  
048.1050MA.2M black tex

**built-up**  
50W 1050mA - dimmable - push 1-10V  
50W 1050mA - dimmbar - push 1-10V

**P040/.. - STRAIN RELIEF - TREKONTLASTING**

IP20    



strain relief  
Zugentlastung

**Dimensions**

↔ Ø15xH21

**Materials**

aluminium	1	2	11	14	1M	2M
brass			4	13	16	23
red copper						28

**Ref**

P040.1	white
P040.1M	white tex
P040.2	black
P040.2M	black tex
P040.4	shiny gold
P040.11	alu grey
P040.13	bronze
P040.14	alu satin
P040.16	satin gold
P040.23	dark bronze
P040.28	rosé

to be fixed to rosette or ceiling light  
für Montage auf Rosette oder Deckenleuchte

**P039/.. - STRAIN RELIEF - TREKONTLASTING**

IP20    



strain relief  
Zugentlastung

**Dimensions**

↔ Ø15xH21

**Materials**

aluminium	1	2	11	14	1M	21	2M	44	46	53	
brass								4	13	16	23
red copper											28

**Ref**

P039.1	white
P039.1M	white tex
P039.2	black
P039.2M	black tex
P039.4	shiny gold
P039.11	alu grey
P039.13	bronze
P039.14	alu satin
P039.16	satin gold
P039.21	rust
P039.23	dark bronze
P039.28	rosé
P039.44	anthracite grey
P039.46	grey-brown
P039.53	bronze-brown

to be fixed to rosette or ceiling light  
für Montage auf Rosette oder Deckenleuchte

000C/.. - TREKONTLASTING PER PENDEL TEXTILE

IP20    

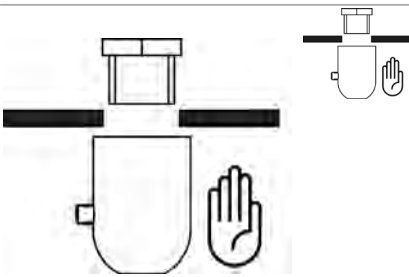

drawing holes + drilling + strain relief  
Zeichnen Locher + Bohrung + Zugentlastung

**Dimensions**

↔ Ø15xH21





**Materials**

aluminium 11 | 14 | 1M | 21 | 2M | 46 | 53  
brass 13 | 16 | 23

**Ref**

000C.1M white tex  
000C.2M black tex  
000C.11 alu grey  
000C.13 bronze  
000C.14 alu satin  
000C.16 satin gold  
000C.21 rust  
000C.23 dark bronze  
000C.46 grey-brown  
000C.53 bronze-brown

000CR/.. - TREKONTLASTING PER PENDEL TEXTILE

IP20    

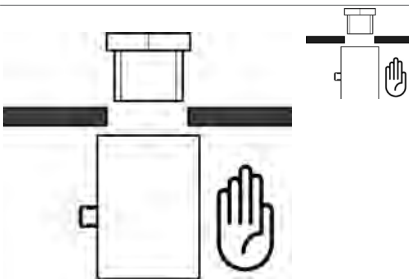

drawing holes + drilling + strain relief  
Zeichnen Locher + Bohrung + Zugentlastung

**Dimensions**

↔ Ø15xH21

**Materials**

aluminium 1 | 2 | 11 | 14 | 1M | 21 | 2M | 44 | 46 | 53  
brass 4 | 13 | 16 | 23

**Ref**

000CR.1 white  
000CR.1M white tex  
000CR.2 black  
000CR.2M black tex  
000CR.4 shiny gold  
000CR.11 alu grey  
000CR.13 bronze  
000CR.14 alu satin  
000CR.16 satin gold  
000CR.21 rust  
000CR.23 dark bronze  
000CR.44 anthracite grey  
000CR.46 grey-brown  
000CR.53 bronze-brown

*built-up*

DEMOWAAIER/.. - DEMO KLEURENWAAIER

IP 



nett price  
Nettopreis

Ref  
DEMOWAAIER

DEMO TEXTILE CABLE/.. - DEMO TEXTIELCABLE

IP 



nett price  
Nettopreis

Ref  
DEMO TEXTILE CABLE

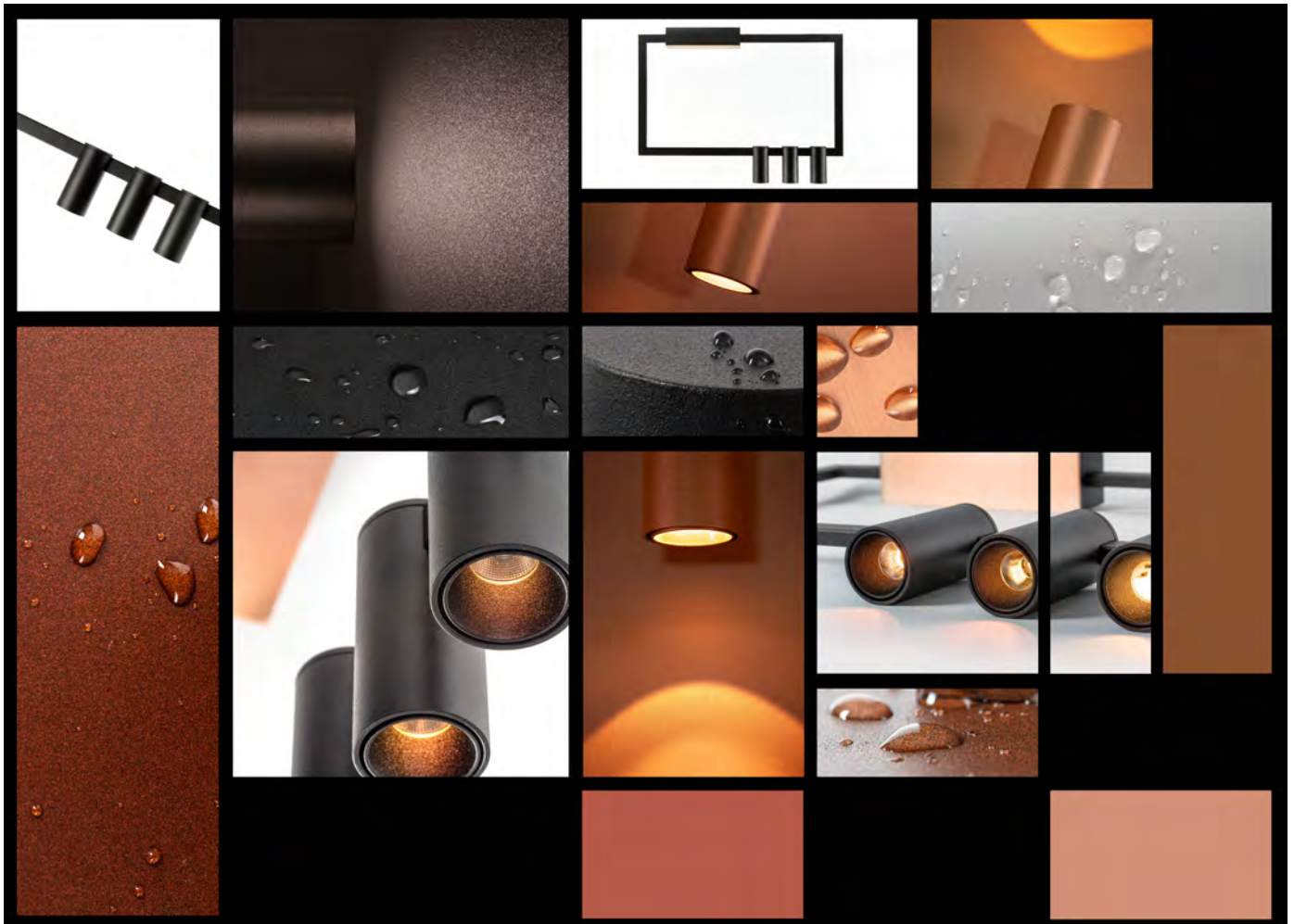

AR62GU10/.. - LED

~230V



IP20



0,5 m



05.20.03



Lamptype

1x QPAR70 GU10 max. 8W ▶

230V

Ref

AR62GU10.WW

led warm white

AR70GU10/.. - LED

~230V



IP20



0,5 m



05.20.03



Lamptype

1x QPAR70 GU10 max. 8W ▶

230V

Ref

AR70GU10.WW

led warm white





SLO\_T1\_D15/.. - LEDMODULET1

=350mA IP20 0,5 m 05.20.50



LED module - lens - without LED driver  
LED Modul - Objektiv - ohne Driver LED

Ref cat (STD)

SLO\_T1\_D15

CW | NW | WW

Lamp type

1x LED 735lm CRI90 max. 6W 350mA

Dimensions

Ø35xH70 15

SLO\_T1\_D30/.. - LEDMODULET1

=350mA IP20 0,5 m 05.20.50



LED module - lens - without LED driver  
LED Modul - Objektiv - ohne Driver LED

Ref

SLO\_T1\_D30

CW | NW | WW

Lamp type

1x LED 735lm CRI90 max. 6W 350mA

Dimensions

Ø35xH70 30

SLO\_T1\_D36/.. - LEDMODULET1

=350mA IP20 0,1200 0,5 m 05.20.50



LED module - lens - without LED driver  
LED Modul - Objektiv - ohne Driver LED

Ref cat (STD)

SLO\_T1\_D36

CW | NW | WW

Lamp type

1x LED 735lm CRI90 max. 6W 350mA

Dimensions

Ø35xH70 36

SLO\_T1\_D45/.. - LEDMODULET1

=350mA IP20 0,5 m 05.20.50



LED module - lens - without LED driver  
LED Modul - Objektiv - ohne Driver LED

Ref cat (STD)

SLO\_T1\_D45

CW | NW | WW

Lamp type

1x LED 735lm CRI90 max. 6W 350mA

Dimensions

Ø35xH70 45

AC\_700\_D24/.. - LEDMODULE AC

~230V  IP  



led module - SLA AC Module + fixation spot  
LED-Module - SLA AC Module + Befestigung spot

Lamp type

 1x LED AC 700lm CRI92 max. 9,5W  230V

Dimensions

 Ø50xH95  24° reflector

Ref

AC_700_D24.WW	led warm white
AC_700_D24.NW	led natural white
AC_700_D24.CW	led cold white



AC\_700\_D36/.. - LEDMODULE AC

~230V   IP   





led module - SLA AC Module + fixation spot  
LED-Module - SLA AC Module + Befestigung spot

Lamp type

 1x LED AC 700lm CRI92 max. 9,5W  230V

Dimensions

 Ø50xH95  36° reflector

Ref

AC_700_D36.WW	led warm white
AC_700_D36.NW	led natural white
AC_700_D36.CW	led cold white



DC\_1200\_D24/.. - LEDMODULE DC

=350mA IP 0,5 m



led module - SLA DC Module + fixation spot - without LED driver  
LED-Module - SLA DC Module + Befestigung spot - ohne Driver LED

**Ref**  
DC\_1200\_D24 CW | NW | WW

**Lamptype**  
1x LED DC 1200lm CRI92 max. 12,2W 350mA  
**Dimensions**  
Ø50xH80  $\setminus$  24° reflector

DC\_1200\_D36/.. - LEDMODULE DC

=350mA IP 0,1100 0,5 m



led module - SLA DC Module + fixation spot - without LED driver  
LED-Module - SLA DC Module + Befestigung spot - ohne Driver LED

**Ref**  
DC\_1200\_D36.WW led warm white  
DC\_1200\_D36.NW led natural white  
DC\_1200\_D36.CW led cold white

**Lamptype**  
1x LED DC 1200lm CRI92 max. 12,2W 350mA  
**Dimensions**  
Ø50xH80  $\setminus$  36° reflector

DC\_700\_D24/.. - LEDMODULE DC

=250mA IP 20 0,5 m



led module - SLA DC Module + fixation spot - without LED driver  
LED-Module - SLA DC Module + Befestigung spot - ohne Driver LED

**Ref**  
DC\_700\_D24 CW | NW | WW

**Lamptype**  
1x LED DC 700lm CRI92 max. 8,8W 250mA  
**Dimensions**  
Ø50xH70  $\setminus$  24° reflector

DC\_700\_D36/.. - LEDMODULE DC

=250mA IP 20 0,1800 0,5 m







led module - SLA DC Module + fixation spot - without LED driver  
LED-Module - SLA DC Module + Befestigung spot - ohne Driver LED

**Ref**  
DC\_700\_D36 CW | NW | WW

**Lamptype**  
1x LED DC 700lm CRI92 max. 8,8W 250mA  
**Dimensions**  
Ø50xH70  $\setminus$  36° reflector



**NOVAFLAT/.. - NOVA FLAT + DRIVER**

~230V   IP20  0,5 m  



- with LED driver  
- mit Driver LED





**Lamptype**

 1x LED 450lm CRI98 max. 6W  120mA

**Ref**

NOVAFLAT.WW	led warm white
NOVAFLAT.NW	led natural white



**NOVA/.. - NOVA + DRIVER**

~230V   IP20  0,5 m  



- with LED driver  
- mit Driver LED





**Lamptype**

 1x LED 670lm CRI98 max. 8W  180mA

**Ref**

NOVA.WW	led warm white
NOVA.NW	led natural white



**NOVASOFT/.. - NOVA SOFT DIM**

~230V   IP20  0,5 m  



- with LED driver  
- mit Driver LED

**Lamptype**

 1x Led 475lm CRI95 max. 9W  -  180mA

**Ref**

NOVASOFT.WW	led warm white
NOVASOFT.NW	led natural white

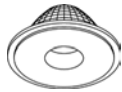

NOVA.D15/.. - NOVA LED LENS

IP20  



Lens 15°  
Lens 15°

Dimensions

 Ø50  15

Ref cat (STD)  
NOVA.D15

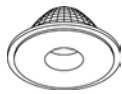

NOVA.D60/.. - NOVA LED LENS

IP20  



Lens 60°  
Lens 60°

Dimensions

 Ø50  60





Ref cat (STD)  
NOVA.D60







4802/.. - MERO 1FASE

~230V  IP20   



Track 2 meter for 1 circuit  
Aufbauschiene 2 Meter für einen Stromkreis

Ref cat (LONG)

4802.1 white  
4802.2 black

Dimensions





↔ L2000

Materials

aluminium 1 | 2

*built-up*  
extra transport cost - long profile  
Transportkostenzuschlag - langes Profil

4803/.. - MERO 1FASE

~230V  IP20   



Track 3 meter for 1 circuit  
Aufbauschiene 3 Meter für einen Stromkreis

Ref cat (LONG)

4803.1 white  
4803.2 black

Dimensions

↔ L3000

Materials

aluminium 1 | 2

*built-up*  
extra transport cost - long profile  
Transportkostenzuschlag - langes Profil

4804/.. - MERO 1FASE

~230V  IP20   



Track 4 meter for 1 circuit  
Aufbauschiene 4 Meter für einen Stromkreis

Ref cat (LONG)

4804.1 white  
4804.2 black

Dimensions

↔ L4000

Materials

aluminium 1 | 2

*built-up*  
extra transport cost - long profile  
Transportkostenzuschlag - langes Profil

4820/.. - MERO 1FASE

~230V  IP20   



Multi-adaptor for 1 circuit track + retaining collar M10x1  
Multi-Adapter für 1 Phase Stromschiene + Montagenippel M10x1

Ref

4820.1 white  
4820.2 black

Dimensions

↔ L130

Materials

aluminium 1 | 2

*built-up*

4805/.. - MERO 1FASE

~230V  IP20    1,5 m 



Adaptor for suspension - steel cable 1,5m  
Adapter mit Seilbefestigung - Stahlkabel 1,5m

Ref cat (LONG)  
4805

*built-up*

4806/.. - MERO 1FASE

~230V  IP20    3 m 



Adaptor for suspension - steel cable 3m  
Adapter mit Seilbefestigung - Stahlkabel 3m

Ref cat (LONG)  
4806

*built-up*





4807/.. - MERO 1FASE

~230V  IP20   



I-connector with connection option for power supply  
I-Verbindung mit Einspeisemöglichkeit

**Dimensions**

↔ L107xB36xH23

**Materials**

aluminium

**Ref**

4807.1

white

4807.2

black

1 | 2

built-up

4808/.. - MERO 1FASE

~230V  IP20   



T-connector with connection option for power supply -  
grounding inside  
T-Verbindung mit Einspeisemöglichkeit - Schutzleiter innen

**Dimensions**

↔ L71xB71xH23

**Materials**

aluminium

**Ref**

4808.1

white

4808.2

black

1 | 2

built-up

Please attach drawing to the order!  
Bitte eine Zeichnung an der Bestellung hinzufügen!

4810/.. - MERO 1FASE

~230V  IP20   



X-connector with connection option for power supply  
X-Verbindung mit Einspeisemöglichkeit

**Dimensions**

↔ L78xB78xH23

**Materials**

aluminium

**Ref**

4810.1

white

4810.2

black

1 | 2



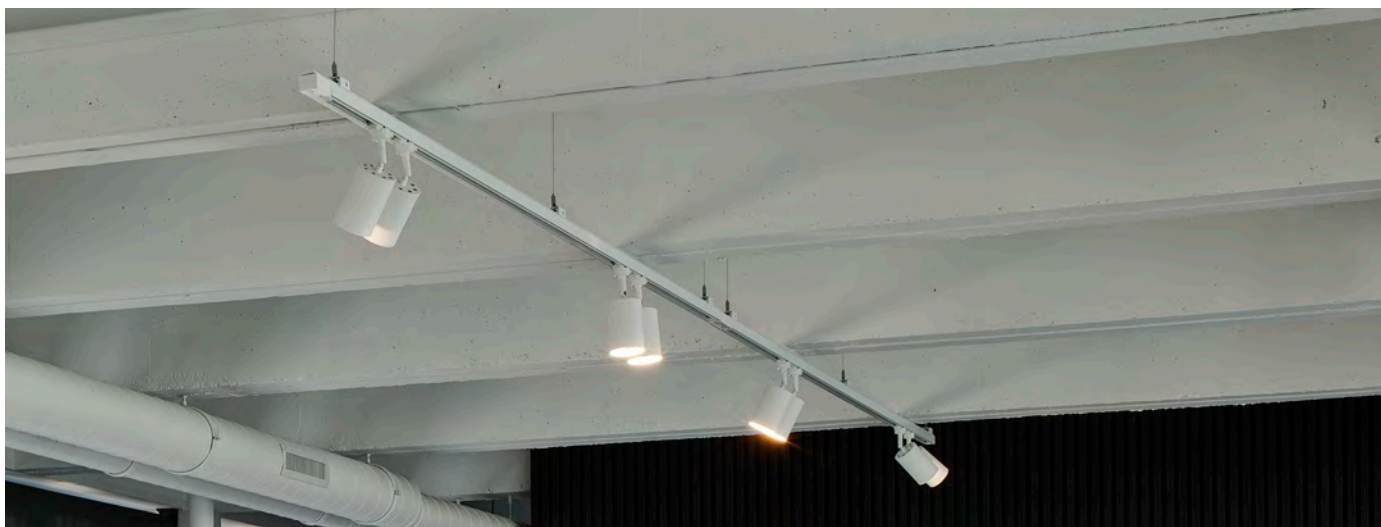

built-up







4811/.. - MERO 1FASE

~230V  IP20   



End feed  
Einspeiser  
**Materials**  
aluminium

**Ref**  
4811.1 white  
4811.2 black

1 | 2

**built-up**  
Please attach drawing to the order!  
Bitte eine Zeichnung an der Bestellung hinzufügen!

4813/.. - MERO 1FASE

IP20   





End cap  
Endkappe  
**Materials**  
aluminium

**Ref**  
4813.1 white  
4813.2 black

1 | 2

**built-up**

4814/.. - MERO 1FASE

~230V  IP20   



Straight coupler  
Längsverbinder  
**Materials**  
aluminium

**Ref**  
4814.1 white  
4814.2 black

1 | 2

**built-up**

4815/.. - MERO 1FASE

~230V  IP20   

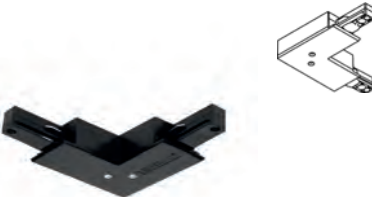

L-connector with connection option for power supply -  
grounding inside  
L-Verbindung mit Einspeisemöglichkeit - Schutzleiter innen  
**Dimensions**  
L71xB71xH23  
**Materials**  
aluminium

**Ref**  
4815.1 white  
4815.2 black

1 | 2

**built-up**  
Please attach drawing to the order!  
Bitte eine Zeichnung an der Bestellung hinzufügen!

4816/.. - MERO 1FASE

~230V



IP20



Flex-connector  
Flex-Verbinder

**Materials**  
aluminium

**Ref**

4816.1

white

4816.2

black

1 | 2

**built-up**  
from 60° to 300°  
von 60° bis 300°

4817/.. - MERO 1FASE

~230V



IP20

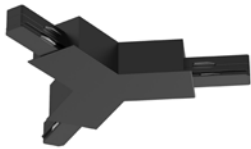

Y-connector with connection option for power supply  
Y-Verbindung mit Einspeisemöglichkeit

**Dimensions**

↔ L78xB78xH23

**Materials**

aluminium

**Ref**

4817.1

white

4817.2

black

1 | 2

**built-up**  
Please attach drawing to the order!  
Bitte eine Zeichnung an der Bestellung hinzufügen!



8110/.. - MERO 3FASE TRACK

~230V  IP20    1,9500 



Track 2 meter for 3 circuits  
Aufbauschiene 2 Meter für drei Stromkreise

Ref cat (LONG)

8110.1 white  
8110.2 black

Dimensions

↔ L2000

Materials

aluminium 1 | 2

*built-up*  
extra transport cost - long profile  
Transportkostenzuschlag - langes Profil

8111/.. - MERO 3FASE TRACK

~230V  IP20    2,9000 



Track 3 meter for 3 circuits  
Aufbauschiene 3 Meter für drei Stromkreise

Ref cat (LONG)

8111.1 white  
8111.2 black

Dimensions

↔ L3000

Materials

aluminium 1 | 2

*built-up*  
extra transport cost - long profile  
Transportkostenzuschlag - langes Profil

8115/.. - MERO 3FASE ADAPTOR

~230V  IP20    0,0600 



Multi-adaptor for 3 circuit track + retaining collar M10x1  
Multi-Adapter für 3 Phasen Stromschiene + Montagenippel M10x1

Ref

8115.1 white  
8115.2 black

Materials

aluminium 1 | 2

*built-up*

8135/.. - MERO 3FASE MULTI ADAPTOR LED



Multi-adaptor with LED-driver | 350mA-500mA | 21W  
 Multi-Adapter mit LED-driver | 350mA-500mA | 21W

**Materials**  
 aluminium 1 | 2

**Ref**  
 8135.1 white  
 8135.2 black

8136/.. - MERO 3FASE MULTI ADAPTOR LED



Multi-adaptor with LED-driver | 500mA-700mA | 30W  
 Multi-Adapter mit LED-driver | 500mA-700mA | 30W

**Materials**  
 aluminium 1 | 2

**Ref**  
 8136.1 white  
 8136.2 black

8137/.. - MERO 3FASE MULTI ADAPTOR LED



Combined In-Track Adapter | max. 30W | 200mA-700mA  
 Combined In-Track Adapter | max. 30W | 200mA-700mA

**Materials**  
 aluminium 1 | 2

**Ref**  
 8137.1 white  
 8137.2 black

8127/.. - MERO 3 FASE ADAPTOR



Combined In-Track Adapter | max. 30W | 200mA-700mA  
 Combined In-Track Adapter | max. 30W | 200mA-700mA

**Materials**  
 aluminium 1 | 2

**Ref**  
 8127.1 white  
 8127.2 black



8128/.. - TRACK 3 FASE ADAPTOR



Combined In-Track Adapter | max. 42W | 300mA-1050mA  
 Combined In-Track Adapter | max. 42W | 300mA-1050mA

**Materials**  
 aluminium

**Ref**  
 8128.1  
 8128.2

white  
 black

1 | 2





8112/.. - MERO 3FASE FEEDING

~230V  IP20    



End feed  
Einspeiser  
**Materials**  
aluminium

**Ref**  
8112.1 white  
8112.2 black

1 | 2

built-up

8120/.. - MERO 3FASE TRACK

~230V  IP20    



L-connector with connection option for power supply  
L-Verbindung mit Einspeisemöglichkeit  
**Dimensions**  
L120  
**Materials**  
aluminium

**Ref**  
8120.1 white  
8120.2 black

1 | 2

built-up

8121/.. - MERO 3FASE TRACK

~230V  IP20    



L-connector with connection option for power supply -  
grounding outside  
L-Verbindung mit Einspeisemöglichkeit - Schutzleiter außen  
**Dimensions**  
L78xB78xH23  
**Materials**  
aluminium

**Ref**  
8121.1 white  
8121.2 black

1 | 2

built-up

Please attach drawing to the order!  
Bitte eine Zeichnung an der Bestellung hinzufügen!

8122/.. - MERO 3FASE TRACK

~230V  IP20   



L-connector with connection option for power supply -  
grounding inside  
L-Verbindung mit Einspeisemöglichkeit - Schutzleiter innen  
**Dimensions**  
L78xB78xH23  
**Materials**  
aluminium

**Ref**  
8122.1 white  
8122.2 black

1 | 2

built-up

Please attach drawing to the order!  
Bitte eine Zeichnung an der Bestellung hinzufügen!

8125/.. - MERO 3FASE TRACK

~230V  IP20    



T-connector with connection option for power supply -  
grounding outside  
T-Verbindung mit Einspeisemöglichkeit - Schutzleiter außen

**Dimensions**  
L78xB78xH

**Materials**  
aluminium 1 | 2

**Ref**  
8125.1 white  
8125.2 black

**built-up**  
Please attach drawing to the order!  
Bitte eine Zeichnung an der Bestellung hinzufügen!

8126/.. - MERO 3FASE TRACK

~230V  IP20   



T-connector with connection option for power supply -  
grounding inside  
T-Verbindung mit Einspeisemöglichkeit - Schutzleiter innen

**Dimensions**  
L78xB78xH

**Materials**  
aluminium 1 | 2

**Ref**  
8126.1 white  
8126.2 black

**built-up**  
Please attach drawing to the order!  
Bitte eine Zeichnung an der Bestellung hinzufügen!

8114/.. - MERO 3FASE TRACK

~230V  IP20    



Straight coupler  
Längsverbinder

**Materials**  
aluminium 1 | 2

**Ref**  
8114.1 white  
8114.2 black

**built-up**

8113/.. - MERO 3FASE TRACK

IP20    



End cap  
Endkappe

**Materials**  
aluminium 1 | 2

**Ref**  
8113.1 white  
8113.2 black

**built-up**







8082/.. - MERO 48V TRACK

III IP20   



4-conductor surface track 48VDC - 2 meter  
4-Leiter Aufbauschiene 48VDC - 2 Meter

**Dimensions**  
L2000

**Materials**  
aluminium

**Ref cat (LONG)**

8082.1 white  
8082.2 black

1 | 2

*built-up*  
extra transport cost - long profile  
Transportkostenzuschlag - langes Profil

8083/.. - MERO 48V TRACK

III IP20   



4-conductor surface track 48VDC - 3 meter  
4-Leiter Aufbauschiene 48VDC - 3 Meter

**Materials**  
aluminium

**Ref**

8083.1 white  
8083.2 black

1 | 2

*built-up*  
extra transport cost - long profile  
Transportkostenzuschlag - langes Profil

8080/.. - MERO 48V ADAPTOR

III IP20   



Led-track adaptor + retaining collar M10x1  
Led-track Adapter + Montagenippel M10x1

**Materials**  
aluminium

**Ref**

8080.1 white  
8080.2 black

1 | 2

*built-up*

8085/.. - MERO 48V ENDFEED L

IP20



End current-supply left  
Endstück Einspeiser links

**Materials**  
aluminium

**Ref**

8085.1  
8085.2

white  
black

1 | 2

built-up

8086/.. - MERO 48V ENDFEED R

IP20



End current-supply right  
Endstück Einspeiser rechts

**Materials**  
aluminium

**Ref**

8086.1  
8086.2

white  
black

1 | 2

built-up

8087/.. - MERO 48V COUPLER

IP20



Straight coupler  
Längsverbinder

**Materials**  
aluminium

**Ref**

8087.1  
8087.2

white  
black

1 | 2

built-up

8088/.. - MERO 48V ENDCAP

IP20



End cap  
Endkappe

**Materials**  
aluminium

**Ref**

8088.1  
8088.2

white  
black

1 | 2

built-up



# INDOOR SPOTS

# Index

## A

APOLLO 153

## C

CAPA 143/147

CAPA X 144- 146

CAPA XL 145

CAPRI 153/170

COCTAIL 164

COLIBRI 166

COMMA 171-172

CONDOR 170

## D

DISCOVERY 168

DISCUS 152/167

DOMINO 169

## F

FIXER 154-158

FLASH 147

FLEX 173

FLEX LITTLE CAPA 174

FOLIO 161

## G

GLOBO 163

## J

JACOB 141

JACOB M 142

JAZZ 164

JUPITER 169

## M

MAESTRO 136

MERO 137

MERO 138

MERO XICATO 48V 140

MERO XICATO 700MA 138

## O

ORKA 174-175

## P

PULA 161

## R

RINGO 151

## S

STEP 152/168

## T

TONDO 148-150

TORPEDO 162

TUBA 166

TWIST B3 175

## U

UTOPIE 162

## V

VICTOR 151

VIOLA 167

VOLTA 160

VOLTA FLEX 159

## INDOOR | Ceiling UP | Spots | MAESTRO

All M10 spotlights and pendants can be combined with bases (built-in & built-up) and Juba bases as preferred.

Alle M10 Aufbaustrahler und Pendelleuchten können mit Rosetten (In- & Aufbau) und Juba Basen nach Wahl kombiniert werden.

### 5037X/.. - MAESTRO - M10

~230V



built-up spot M10 - round - directional  
Aufbaustrahler M10 - rund - schwenkbar

#### Lamp type

1x A60 E27 max. 10,5W A - E **230V**

#### Dimensions

Ø45xH110

#### Materials

aluminium 14 | 1M | 2M | 11M

#### Ref

5037X.1M	white tex
5037X.2M	black tex
5037X.11M	grey tex
5037X.14.11	alu satin

built-up

### 5037.400/.. - MAESTRO - M10

~230V



built-up spot M10 - round - directional - with bar  
Aufbaustrahler M10 - rund - schwenkbar - mit Stange

#### Lamp type

1x G125 E27 max. 4W A - E **240V**

#### Dimensions

Ø45xH460 - Bar 400

#### Options

019 - KNEEJOINT  
024 - CONNECTOR FOR TRACKS

#### Materials

aluminium 14 | 1M | 2M | 46 | 11M

#### Ref

5037.400.1M	white tex
5037.400.2M	black tex
5037.400.11M	grey tex
5037.400.14.11	alu satin
5037.400.46	grey-brown

built-up

### 5037.650/.. - MAESTRO - M10

~230V



built-up spot M10 - round - directional - with bar  
Aufbaustrahler M10 - rund - schwenkbar - mit Stange

#### Lamp type

1x G125 E27 max. 4W A - E **240V**

#### Dimensions

Ø45xH710 - Bar 650

#### Options

019 - KNEEJOINT  
024 - CONNECTOR FOR TRACKS

#### Materials

aluminium 1M | 2M | 46

#### Ref

5037.650.1M	white tex
5037.650.2M	black tex
5037.650.46	grey-brown

built-up

### 5037.800/.. - MAESTRO - M10

~230V



built-up spot M10 - round - directional - with bar  
Aufbaustrahler M10 - rund - schwenkbar - mit Stange

#### Lamp type

1x G125 E27 max. 4W A - E **240V**

#### Dimensions

Ø45xH860 - Bar 800

#### Options

019 - KNEEJOINT  
024 - CONNECTOR FOR TRACKS

#### Materials

aluminium 14 | 1M | 2M | 46

#### Ref

5037.800.1M	white tex
5037.800.2M	black tex
5037.800.14.11	alu satin
5037.800.46	grey-brown

built-up

All M10 spotlights and pendants can be combined with bases (built-in & built-up) and Juba bases as preferred.

Alle M10 Aufbaustrahler und Pendelleuchten können mit Rosetten (In- & Aufbau) und Juba Basen nach Wahl kombiniert werden.

1837.1000/.. - MERO 230V

~230V



IP20



built-up spot LED M10 - round - directional  
Aufbaustrahler LED M10 - rund - schwenkbar

Lamp type

1x LED 850lm CRI90 max. 10W

230V

Dimensions

Ø80xH180 40° reflector

Head - Ø80xH120

Ref cat (STD)

1837.1000.1M

1837.1000.2M

NW | WW

NW | WW

**built-up**

to combine with adaptor or on a profile

zu kombinieren mit einem Adapter oder auf einem

Profil



## INDOOR | Ceiling UP | Spots | MERO

All M10 spotlights and pendants can be combined with bases (built-in & built-up) and Juba bases as preferred.

Alle M10 Aufbaustrahler und Pendelleuchten können mit Rosetten (In- & Aufbau) und Juba Basen nach Wahl kombiniert werden.

### 7877/.. - MERO XICATO

=700mA



built-up spot LED M10 - round - directional - without LED driver  
Aufbaustrahler LED M10 - rund - schwenkbar - ohne Driver LED

#### Ref

7877.1M

CW | NW | WW

7877.2M

CW | NW | WW

#### Lamp type

1x Led 1300lm CRI80 max. 9,5W **A** - **A+** 700mA

#### Dimensions

Ø80xH145  $\wedge$  28

Head - Ø80xH85

#### built-up

to combine with adaptor or on a profile

zu kombinieren mit einem Adapter oder auf einem Profil

### 7878/.. - MERO XICATO 700MA

=700mA



built-up spot LED M10 - round - directional - without LED driver  
Aufbaustrahler LED M10 - rund - schwenkbar - ohne Driver LED

#### Ref cat (STD)

7878.1M

NW | WW

7878.2M

NW | WW

#### Lamp type

1x Led 1300lm CRI80 max. 9,5W **A** - **A+** 700mA

#### Dimensions

Ø80xH170  $\wedge$  40° reflector

Head - Ø80xH120

#### Options

TR89800257 - DRIVER

#### built-up

CRI90-95 on request

CRI90-95 auf Anfrage

to combine with adaptor or on a profile

zu kombinieren mit einem Adapter oder auf einem Profil

### 7879/.. - MERO SPOT

=700mA



built-up spot LED M10 - round - directional - tube Ø60 - L 130mm - without LED driver  
Aufbaustrahler LED M10 - rund - schwenkbar - Rohr Ø60 - L 130mm - ohne Driver LED

#### Ref

7879.1M

NW | WW

7879.2M

NW | WW

7879.16

NW | WW

#### Lamp type

1x Led 1300lm CRI80 max. 9,5W **A** - **A+** 700mA

#### Dimensions

Ø60xH180  $\wedge$  40° reflector

Head - Ø60xH130

#### built-up

to combine with adaptor or on a profile

zu kombinieren mit einem Adapter oder auf einem Profil





SIZES  
36-48

## INDOOR | Ceiling UP | Spots | MERO

All M10 spotlights and pendants can be combined with bases (built-in & built-up) and Juba bases as preferred.

Alle M10 Aufbaustrahler und Pendelleuchten können mit Rosetten (In- & Aufbau) und Juba Basen nach Wahl kombiniert werden.

### 7880.1300/.. - MERO XICATO 48V

=48V-DC



built-up spot LED M10 - round - directional - 48V 1300lm - without transformer  
Aufbaustrahler LED M10 - rund - schwenkbar - 48V 1300lm - ohne Trafo

#### Ref cat (STD)

7880.1300.1M	NW   WW
7880.1300.2M	NW   WW

#### Lamp type

1x LED 1300lm CRI80 max. 12,6W 48V-DC

#### Dimensions

Ø80xH170 40° reflector  
Head - Ø80xH120

#### Options

RSLP035-48 - TRANSFO  
TR122411 - MULTI DRIVER - TRANSFO

#### built-up

to combine with adaptor or on a profile  
zu kombinieren mit einem Adapter oder auf einem Profil  
1 - 10V

### 7880.2000/.. - MERO XICATO 48V

=48V-DC



built-up spot LED M10 - round - directional - 48V 2000lm - without transformer  
Aufbaustrahler LED M10 - rund - schwenkbar - 48V 2000lm - ohne Trafo

#### Ref cat (STD)

7880.2000.1M	NW   WW
7880.2000.2M	NW   WW

#### Lamp type

1x LED 2000lm CRI80 max. 19,1W 48V-DC

#### Dimensions

Ø80xH170 40° reflector  
Head - Ø80xH120

#### Options

RSLP035-48 - TRANSFO  
TR122411 - MULTI DRIVER - TRANSFO

#### built-up

to combine with adaptor or on a profile  
zu kombinieren mit einem Adapter oder auf einem Profil  
1 - 10V

### 7880.3000/.. - MERO XICATO 48V

=48V-DC



built-up spot LED M10 - round - directional - 48V 3000lm - without transformer  
Aufbaustrahler LED M10 - rund - schwenkbar - 48V 3000lm - ohne Trafo

#### Ref cat (STD)

7880.3000.1M	NW   WW
7880.3000.2M	NW   WW

#### Lamp type

1x LED 3000lm CRI80 max. 31,3W 48V-DC

#### Dimensions

Ø80xH170 40° reflector  
Head - Ø80xH120

#### Options

RSLP035-48 - TRANSFO  
TR122411 - MULTI DRIVER - TRANSFO

#### built-up

to combine with adaptor or on a profile  
zu kombinieren mit einem Adapter oder auf einem Profil  
1 - 10V



All M10 spotlights and pendants can be combined with bases (built-in & built-up) and Juba bases as preferred.

Alle M10 Aufbaustrahler und Pendelleuchten können mit Rosetten (In- & Aufbau) und Juba Basen nach Wahl kombiniert werden.

**3960.ES50.MR11/.. - JACOB**

~230V  IP20     0,1700  0,5 m  05.20.02 



built-up spot M10 - round - directional  
Aufbaustrahler M10 - rund - schwenkbar

**Lamp type**

1x QPAR35 GU10 max. 4W 230V

**Dimensions**

Ø40xH130  
Head - Ø40xH85

**Materials**

aluminium 14 | 1M | 2M

**Ref**

3960.ES50.MR11.1M	white tex
3960.ES50.MR11.2M	black tex
3960.ES50.MR11.14	alu satin

built-up

**3985M/.. - JACOB 3,8W WITH BASE**

=350mA  IP20     0,2300  0,5 m  05.20.50 



built-up spot LED M10 - round - with base 005 - without LED driver  
Aufbaustrahler LED M10 - rund - mit Basis 005 - ohne Driver LED

**Lamp type**

1x led 467lm CRI80 max. 3,8W  350mA

**Dimensions**

Ø60xH155  48° reflector  
Base - Ø60xH25  
Head - Ø40xH85

**Ref**

3985M.1M	NW   WW
3985M.2M	NW   WW
3985M.4	NW   WW
3985M.11M	NW   WW
3985M.14	NW   WW
3985M.16	NW   WW
3985M.29	NW   WW
3985M.49	NW   WW

built-up



# INDOOR | Ceiling UP | Spots | JACOB

All M10 spotlights and pendants can be combined with bases (built-in & built-up) and Juba bases as preferred.

Alle M10 Aufbaustrahler und Pendelleuchten können mit Rosetten (In- & Aufbau) und Juba Basen nach Wahl kombiniert werden.

## 3986M/.. - JACOB M - M10

=350mA



built-up spot LED M10 - round - directional - without LED driver  
Aufbaustrahler LED M10 - rund - schwenkbar - ohne Driver LED

### Lamp type

1x led 467lm CRI80 max. 3,8W A - A 350mA

### Dimensions

Ø40xH130 48° reflector

Head - Ø40xH85

### Options

TR89800255 - DRIVER

### Ref cat (STD)

3986M.1M	NW   WW
3986M.2M	NW   WW
3986M.4	NW   WW
3986M.11M	NW   WW
3986M.14	NW   WW
3986M.16	NW   WW
3986M.29	NW   WW
3986M.47	NW   WW
3986M.77	NW   WW

built-up

## 3986M.100/.. - JACOB M - M10

=350mA



built-up spot LED M10 - round - directional - without LED driver  
Aufbaustrahler LED M10 - rund - schwenkbar - ohne Driver LED

### Lamp type

1x led 467lm CRI80 max. 3,8W A - A 350mA

### Dimensions

Ø40xH230 48° reflector - Bar 100

Head - Ø40xH85

### Options

TR89800255 - DRIVER

### Ref cat (STD)

3986M.100.1M	NW   WW
3986M.100.2M	NW   WW
3986M.100.14	NW   WW

built-up

## 3986M.300/.. - JACOB M - M10

=350mA



built-up spot LED M10 - round - directional - without LED driver  
Aufbaustrahler LED M10 - rund - schwenkbar - ohne Driver LED

### Lamp type

1x led 467lm CRI80 max. 3,8W A - A 350mA

### Dimensions

Ø40xH430 48° reflector - Bar 300

Head - Ø40xH85

### Options

TR89800255 - DRIVER

### Ref cat (STD)

3986M.300.1M	NW   WW
3986M.300.2M	NW   WW
3986M.300.14	NW   WW

built-up

## 3982M/.. - JACOB M - M10

=500mA



built-up spot LED M10 - directional - without LED driver  
Aufbaustrahler LED M10 - schwenkbar - ohne Driver LED

### Lamp type

1x led 595lm CRI90 max. 5,8W A - A 500mA

### Dimensions

Ø40xH130 48° reflector

Head - Ø40xH85

### Options

89800255 - DRIVER









### Ref



3982M.1M	NW   WW
3982M.2M	NW   WW
3982M.14	NW   WW
3982M.16	NW   WW
3982M.29	NW   WW
3982M.46	NW   WW
3982M.49	NW   WW
3982M.64	NW   WW

built-up

All M10 spotlights and pendants can be combined with bases (built-in & built-up) and Juba bases as preferred.

Alle M10 Aufbaustrahler und Pendelleuchten können mit Rosetten (In- & Aufbau) und Juba Basen nach Wahl kombiniert werden.

**7700/.. - CAPA - M10** ~230V  IP20     0,1600  1 m  05.20.02 

built-up spot M10 - round - directional - without LED lamp  
Aufbaustrahler M10 - rund - schwenkbar - Ohne LED Lampe

**Lamp type**

 1x QPAR 51 GU10 max. 20W A+ - E **230V**

or  1x QPAR70 GU10 max. 7W A+ **230V**

**Dimensions**

 Ø32xH84 - Bar 50

Head - Ø32xH40

**Options**

024 - CONNECTOR FOR TRACKS









**Materials**



aluminium	14   1M   2M   11M
brass	4   16

**Ref cat (STD)**

7700.1M	white tex
7700.2M	black tex
7700.4	shiny gold
7700.11M	grey tex
7700.14	alu satin
7700.16	satin gold

*built-up*

**7710/.. - CAPA - M10** ~230V  IP20     0,2200  1 m  05.20.02 

built-up spot M10 - round - directional - without LED lamp  
Aufbaustrahler M10 - rund - schwenkbar - Ohne LED Lampe

**Lamp type**

 1x QPAR 51 GU10 max. 20W A+ - E **230V**

or  1x QPAR70 GU10 max. 7W A+ **230V**

**Dimensions**

 Ø32xH84 - Bar 100

**Options**

019 - KNEEJOINT

024 - CONNECTOR FOR TRACKS









**Materials**



aluminium	14   1M   2M   11M
brass	4   16

**Ref cat (STD)**

7710.1M	white tex
7710.2M	black tex
7710.4	shiny gold
7710.11M	grey tex
7710.14.11	alu satin
7710.16	satin gold

*built-up*

**7720/.. - CAPA - M10** ~230V  IP20     0,1200  1 m  05.20.02 

built-up spot M10 - round - directional - without LED lamp  
Aufbaustrahler M10 - rund - schwenkbar - Ohne LED Lampe

**Lamp type**

 1x QPAR 51 GU10 max. 20W A+ - E **230V**

or  1x QPAR70 GU10 max. 7W A+ **230V**

**Dimensions**

 Ø32xH84 - Bar 200

**Options**

019 - KNEEJOINT

024 - CONNECTOR FOR TRACKS

**Materials**

aluminium	14   1M   2M   11M
brass	4   16

**Ref cat (STD)**

7720.1M	white tex
7720.2M	black tex
7720.4	shiny gold
7720.11M	grey tex
7720.14.11	alu satin
7720.16	satin gold

*built-up*





# INDOOR | Ceiling UP | Spots | CAPA

All M10 spotlights and pendants can be combined with bases (built-in & built-up) and Juba bases as preferred.

Alle M10 Aufbaustrahler und Pendelleuchten können mit Rosetten (In- & Aufbau) und Juba Basen nach Wahl kombiniert werden.

## 7800/.. - CAPA X - M10

~230V



built-up spot M10 - round - directional - without LED lamp  
Aufbaustrahler M10 - rund - schwenkbar - Ohne LED Lampe

### Lamp type

1x QPAR 51 GU10 max. 20W A+ - E 230V

### Dimensions

Ø54xH140

Head - Ø54xH85

### Options

024 - CONNECTOR FOR TRACKS

8115 - MERO 3FASE ADAPTOR

### Materials

aluminium 14 | 1M | 2M | 11M  
brass 4 | 16

### Ref cat (STD)

7800.1M	white tex
7800.2M	black tex
7800.4	shiny gold
7800.11M	grey tex
7800.14	alu satin
7800.16	satin gold

built-up

## 7810/.. - CAPA X - M10

~230V

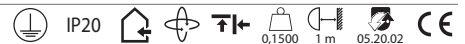

built-up spot M10 - round - directional - without LED lamp  
Aufbaustrahler M10 - rund - schwenkbar - Ohne LED Lampe

### Lamp type

1x QPAR 51 GU10 max. 20W A+ - E 230V

### Dimensions

Ø54xH140 - Bar 100

Head - Ø54xH85

### Options

019 - KNEEJOINT

024 - CONNECTOR FOR TRACKS

### Materials

aluminium 14 | 1M | 2M | 11M  
brass 4 | 16

### Ref cat (STD)

7810.1M	white tex
7810.2M	black tex
7810.4	shiny gold
7810.11M	grey tex
7810.14	alu satin
7810.16	satin gold

built-up

## 7815/.. - CAPA X - M10

~230V

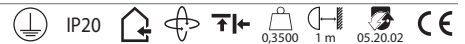

built-up spot M10 - round - directional - without LED lamp  
Aufbaustrahler M10 - rund - schwenkbar - Ohne LED Lampe

### Lamp type

1x QPAR 51 GU10 max. 20W A+ - E 230V

### Dimensions

Ø54xH140 - Bar 150

Head - Ø54xH85

### Options

019 - KNEEJOINT

024 - CONNECTOR FOR TRACKS

### Materials

aluminium 14 | 1M | 2M | 11M

### Ref cat (STD)

7815.1M	white tex
7815.2M	black tex
7815.11M	grey tex
7815.14	alu satin

built-up

## 7820/.. - CAPA X - M10

~230V

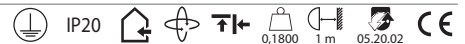

built-up spot M10 - round - directional - without LED lamp  
Aufbaustrahler M10 - rund - schwenkbar - Ohne LED Lampe

### Lamp type

1x QPAR 51 GU10 max. 20W A+ - E 230V

### Dimensions

Ø54xH140 - Bar 200

Head - Ø54xH85

### Options

019 - KNEEJOINT

024 - CONNECTOR FOR TRACKS

### Materials

aluminium 14 | 1M | 2M | 11M  
brass 4 | 16

### Ref cat (STD)

7820.1M	white tex
7820.2M	black tex
7820.4	shiny gold
7820.11M	grey tex
7820.14	alu satin
7820.16	satin gold

built-up

All M10 spotlights and pendants can be combined with bases (built-in & built-up) and Juba bases as preferred.

Alle M10 Aufbaustrahler und Pendelleuchten können mit Rosetten (In- & Aufbau) und Juba Basen nach Wahl kombiniert werden.

**3989M/.. - CAPA XL - M10**

~230V



IP20



0,3200

0,5 m

05.20.50



built-up spot M10 - round - directional - without LED lamp  
 Aufbaustrahler M10 - rund - schwenkbar - Ohne LED Lampe

**Lamp type**

1x QPAR 51 GU10 max. 20W A+ - E 230V

**Dimensions**

Ø60xH169  
 Head - Ø60xH122

**Ref**

- 3989M.1M
- 3989M.2M
- 3989M.4
- 3989M.16
- 3989M.20
- 3989M.23
- 3989M.29
- 3989M.49

*built-up*



SPOTS

# INDOOR | Ceiling UP | Spots | CAPA X

All M10 spotlights and pendants can be combined with bases (built-in & built-up) and Juba bases as preferred.

Alle M10 Aufbaustrahler und Pendelleuchten können mit Rosetten (In- & Aufbau) und Juba Basen nach Wahl kombiniert werden.



## 7600.AC/.. - CAPA X

~230V  IP20       





spotlight - directional - with LED module  
Aufbaustrahler - schwenkbar - mit LED-Modul

### Lamptype

 1x LED AC 700lm CRI92 max. 9,5W  230V

### Dimensions

 Ø58xH180  38° reflector  
Head - Ø58xH130

### Options

8115 - MERO 3FASE ADAPTOR

### Ref cat (STD)

7600C.1M	CW   NW   WW
7600C.2M	CW   NW   WW
7600C.4	CW   NW   WW
7600C.14	CW   NW   WW
7600C.16	CW   NW   WW
7600C.45	CW   NW   WW

**built-up**  
dimmable leading and trailing edge  
dimmbar Phasen- und abschnitt



## 7600.100.AC/.. - CAPA X

~230V  IP20      





spotlight - directional - with LED module  
Aufbaustrahler - schwenkbar - mit LED-Modul

### Lamptype

 1x LED AC 700lm CRI92 max. 9,5W  230V

### Dimensions

 Ø58xH230  36° reflector - Bar 100  
Head - Ø58xH130

### Ref

7600.100C.1M	CW   NW   WW
7600.100C.2M	CW   NW   WW
7600.100C.4	CW   NW   WW
7600.100C.14	CW   NW   WW
7600.100C.16	CW   NW   WW
7600.100C.45	CW   NW   WW

**built-up**  
dimmable leading and trailing edge  
dimmbar Phasen- und abschnitt



## 7600.700.DC/.. - CAPA X

=250mA   IP20      





spotlight - directional - with LED module - without LED driver  
Aufbaustrahler - schwenkbar - mit LED-Modul - ohne Driver LED

### Lamptype

 1x LED DC 700lm CRI92 max. 8,8W  250mA

### Dimensions

 Ø58xH180  36° reflector  
Head - Ø58xH130

### Options

TR28002402 - DRIVER

### Ref cat (STD)

7600.700.DC.1M	CW   NW   WW
7600.700.DC.2M	CW   NW   WW
7600.700.DC.4	CW   NW   WW
7600.700.DC.14	CW   NW   WW
7600.700.DC.16	CW   NW   WW
7600.700.DC.45	CW   NW   WW

**built-up**



## 7600.1200.DC/.. - CAPA X

=350mA   IP20       





spotlight - directional - with LED module - without LED driver  
Aufbaustrahler - schwenkbar - mit LED-Modul - ohne Driver LED

### Lamptype

 1x LED DC 1200lm CRI92 max. 12,2W  350mA

### Dimensions

 Ø58xH180  36° reflector  
Head - Ø58xH130

### Options

TR28002403 - DRIVER  
TR89800255 - DRIVER

### Ref cat (STD)

7600.1200.DC.1M	CW   NW   WW
7600.1200.DC.2M	CW   NW   WW
7600.1200.DC.4	CW   NW   WW
7600.1200.DC.14	CW   NW   WW
7600.1200.DC.16	CW   NW   WW
7600.1200.DC.45	CW   NW   WW

**built-up**

All M10 spotlights and pendants can be combined with bases (built-in & built-up) and Juba bases as preferred.

Alle M10 Aufbaustrahler und Pendelleuchten können mit Rosetten (In- & Aufbau) und Juba Basen nach Wahl kombiniert werden.

**7900/.. - CAPA - M10**

~230V



built-up spot M10 - directional - without LED lamp  
Aufbaustrahler M10 - schwenkbar - Ohne LED Lampe

**Lamp type**

1x QPAR70 GU10 max. 7W **A+** 230V

**Dimensions**

Ø75xH160  
Head - Ø75xH100

**Options**

024 - CONNECTOR FOR TRACKS

**Materials**

aluminium 1M | 2M | 46

**Ref cat (STD)**

7900.1M	white tex
7900.2M	black tex
7900.46	grey-brown

built-up

**7901/.. - CAPA - M10**

~230V



built-up spot M10 - directional - without LED lamp  
Aufbaustrahler M10 - schwenkbar - Ohne LED Lampe

**Lamp type**

1x QPAR70 GU10 max. 7W **A+** 230V

Tube - Ø85xH165  
Head - Ø85xH105

**Materials**

aluminium 1M | 2M | 46

**Ref**

7901.1M	white tex
7901.2M	black tex
7901.46	grey-brown

built-up

**1952.XTM.M10/.. - FLASH M10 - M10**

=700mA



built-up spot M10 - directional - without LED driver  
Aufbaustrahler M10 - schwenkbar - ohne Driver LED

**Lamp type**

1x Led 2000lm CRI80 max. 15,2W **A+** - **A+** 700mA

**Dimensions**

Ø120xH180 40° reflector - Bar 100

**Materials**

aluminium 1M | 2M | 11M

**Ref**

1952.XTM.M10.1M	white tex
1952.XTM.M10.2M.11M	black tex
1952.XTM.M10.11M	grey tex

built-up

to combine with adaptor or on a profile  
zu kombinieren mit einem Adapter oder auf einem Profil





# INDOOR | Ceiling UP | Spots | TONDO

All M10 spotlights and pendants can be combined with bases (built-in & built-up) and Juba bases as preferred.

Alle M10 Aufbaustrahler und Pendelleuchten können mit Rosetten (In- & Aufbau) und Juba Basen nach Wahl kombiniert werden.

## 7535/.. - TONDO XICATO - M10

=500mA

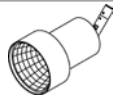

built-up spot LED M10 - directional - down - without LED driver  
 Aufbaustrahler LED M10 - schwenkbar - down - ohne Driver LED

### Ref

7535.1M

NW | WW

7535.2M

NW | WW

### Lamp type

1x Led 965lm CRI80 max. 6,6W A - A+ 500mA

### Dimensions

Ø75xH100  $\setminus$  40° reflector

Reflector - Ø70

### Options

024 - CONNECTOR FOR TRACKS

built-up

## 7536/.. - TONDO XICATO - M10

=500mA

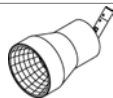

built-up spot LED M10 - directional - down - without LED driver  
 Aufbaustrahler LED M10 - schwenkbar - down - ohne Driver LED

### Ref

7536.1M

NW | WW

7536.2M

NW | WW

### Lamp type

1x Led 965lm CRI80 max. 6,6W A - A+ 500mA

### Dimensions

Ø80xH100  $\setminus$  40° reflector

Reflector - Ø70

### Options

024 - CONNECTOR FOR TRACKS

built-up

## 7537/.. - TONDO XICATO - M10

=500mA

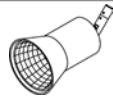

built-up spot LED M10 - directional - down - without LED driver  
 Aufbaustrahler LED M10 - schwenkbar - down - ohne Driver LED

### Ref

7537.1M

NW | WW

7537.2M

NW | WW

### Lamp type

1x Led 965lm CRI80 max. 6,6W A - A+ 500mA

### Dimensions

Ø74xH100  $\setminus$  40° reflector

Reflector - Ø70

### Options

024 - CONNECTOR FOR TRACKS

built-up

## 7538/.. - TONDO XICATO - M10

=500mA

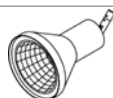

built-up spot LED M10 - directional - down - without LED driver  
 Aufbaustrahler LED M10 - schwenkbar - down - ohne Driver LED

### Ref

7538.1M

NW | WW

7538.2M

NW | WW

### Lamp type

1x Led 965lm CRI80 max. 6,6W A - A+ 500mA

### Dimensions

Ø118xH140  $\setminus$  40° reflector

Reflector - Ø111

### Options

024 - CONNECTOR FOR TRACKS

built-up

All M10 spotlights and pendants can be combined with bases (built-in & built-up) and Juba bases as preferred.

Alle M10 Aufbaustrahler und Pendelleuchten können mit Rosetten (In- & Aufbau) und Juba Basen nach Wahl kombiniert werden.

**7530/.. - TONDO XICATO - M10**

=500mA



built-up spot LED M10 - directional - down - without LED driver  
 Aufbaustrahler LED M10 - schwenkbar - down - ohne Driver LED

Ref	
7530.1M	NW   WW
7530.2M	NW   WW
7530.14	NW   WW

**Lamp type**

1x Led 965lm CRI80 max. 6,6W - 500mA

**Dimensions**

Ø60xH110 40° reflector - Bar 100  
 Reflector - Ø50

**Options**

024 - CONNECTOR FOR TRACKS

built-up  
 reflector Ø50 mm  
 Reflektor Ø50 mm

**7531/.. - TONDO XICATO - M10**

=500mA



built-up spot LED M10 - directional - down - without LED driver  
 Aufbaustrahler LED M10 - schwenkbar - down - ohne Driver LED

Ref	
7531.1M	NW   WW
7531.1M.2M	NW   WW
7531.2M	NW   WW
7531.14	NW   WW

**Lamp type**

1x Led 965lm CRI80 max. 6,6W - 500mA

**Dimensions**

Ø55xH112 40° reflector - Bar 100  
 Reflector - Ø50

**Options**

024 - CONNECTOR FOR TRACKS

built-up

**7540/.. - TONDO XICATO - M10**

=700mA



built-up spot LED M10 - directional - down - without LED driver  
 Aufbaustrahler LED M10 - schwenkbar - down - ohne Driver LED

Ref	
7540.14.2M	NW   WW
7540.14	NW   WW

**Lamp type**

1x Led 1300lm CRI80 max. 9,5W - 700mA

**Dimensions**

Ø50xH110 40° reflector - Bar 100  
 Reflector - Ø50

**Options**

024 - CONNECTOR FOR TRACKS

built-up

**7541/.. - TONDO XICATO - M10**

=700mA



built-up spot LED M10 - directional - down - without LED driver  
 Aufbaustrahler LED M10 - schwenkbar - down - ohne Driver LED

Ref	
7541.1M	NW   WW
7541.1M.2M	NW   WW
7541.2M	NW   WW
7541.14.2M	NW   WW
7541.14	NW   WW

**Lamp type**

1x Led 1300lm CRI80 max. 9,5W - 700mA

**Dimensions**

Ø75xH131 40° reflector - Bar 100  
 Reflector - Ø70

**Options**

024 - CONNECTOR FOR TRACKS

built-up

# INDOOR | Ceiling UP | Spots | TONDO

All M10 spotlights and pendants can be combined with bases (built-in & built-up) and Juba bases as preferred.

Alle M10 Aufbaustrahler und Pendelleuchten können mit Rosetten (In- & Aufbau) und Juba Basen nach Wahl kombiniert werden.

## 7542/.. - TONDO XICATO - M10

=700mA



built-up spot LED M10 - directional - down - without LED driver  
Aufbaustrahler LED M10 - schwenkbar - down - ohne Driver LED

**Ref**  
7542.14.2M  
7542.14

NW | WW  
NW | WW

### Lamp type

1x Led 1300lm CRI80 max. 9,5W **A** - **A+** 700mA

### Dimensions

Ø70xH128 40° reflector - Bar 100

Reflector - Ø70

### Options

024 - CONNECTOR FOR TRACKS

built-up

## 7543/.. - TONDO XICATO - M10

=700mA



built-up spot LED M10 - directional - without LED driver  
Aufbaustrahler LED M10 - schwenkbar - ohne Driver LED

**Ref**  
7543.1M  
7543.1M.2M  
7543.2M  
7543.14.2M  
7543.14

NW | WW  
NW | WW  
NW | WW  
NW | WW  
NW | WW

### Lamp type

1x Led 1300lm CRI80 max. 9,5W **A** - **A+** 700mA

### Dimensions

Ø75xH133 40° reflector - Bar 100

Reflector - Ø70

### Options

024 - CONNECTOR FOR TRACKS

built-up

## 7544/.. - TONDO XICATO - M10

=700mA



built-up spot LED M10 - directional - without LED driver  
Aufbaustrahler LED M10 - schwenkbar - ohne Driver LED

**Ref**  
7544.1M  
7544.1M.2M  
7544.2M  
7544.14.2M  
7544.14

NW | WW  
NW | WW  
NW | WW  
NW | WW  
NW | WW

### Lamp type

1x Led 1300lm CRI80 max. 9,5W **A** - **A+** 700mA

### Dimensions

Ø75xH132 40° reflector - Bar 100

Reflector - Ø70

### Options

024 - CONNECTOR FOR TRACKS

built-up

## 7545/.. - TONDO XICATO - M10

=700mA

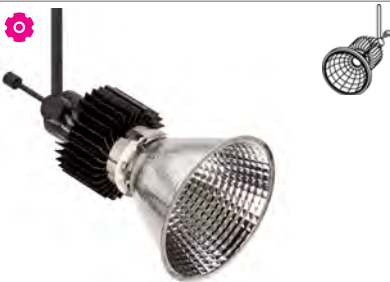

built-up spot LED M10 - directional - down - without LED driver  
Aufbaustrahler LED M10 - schwenkbar - down - ohne Driver LED

**Ref**  
7545.14.2M  
7545.14

NW | WW  
NW | WW

### Lamp type

1x Led 1300lm CRI80 max. 9,5W **A** - **A+** 700mA

### Dimensions

Ø111xH130 40° reflector - Bar 100

Reflector - Ø111

### Options

024 - CONNECTOR FOR TRACKS

built-up

All M10 spotlights and pendants can be combined with bases (built-in & built-up) and Juba bases as preferred.

Alle M10 Aufbaustrahler und Pendelleuchten können mit Rosetten (In- & Aufbau) und Juba Basen nach Wahl kombiniert werden.

**3229/.. - RINGO**

~230V



built-up ceiling light - directional - base not included  
Aufbau Deckenleuchte - schwenkbar - ohne Rosette

**Lamp type**

1x QPAR 51 GU10 max. 20W A+ - E **230V**

**Dimensions**

Ø40xH60

**Materials**

aluminium **14 | 1M | 2M**

**Ref**

3229.1M	white tex
3229.2M	black tex
3229.14	alu satin

built-up  
to combine with all M10 bases  
zu kombinieren mit alle M10 Basissen

**3205/.. - VICTOR**

~230V



built-up ceiling light - directional - base not included  
Aufbau Deckenleuchte - schwenkbar - ohne Rosette

**Lamp type**

1x QPAR 51 GU10 max. 20W A+ - E **230V**

**Dimensions**

Ø38xH72

**Materials**

aluminium **2 | 14 | 1M | 2M | 46 | 33M**

**Ref**

3205.1M	white tex
3205.2	black
3205.2M	black tex
3205.14	alu satin
3205.33M	brown texture
3205.46	grey-brown

built-up  
to combine with all M10 bases  
zu kombinieren mit alle M10 Basissen

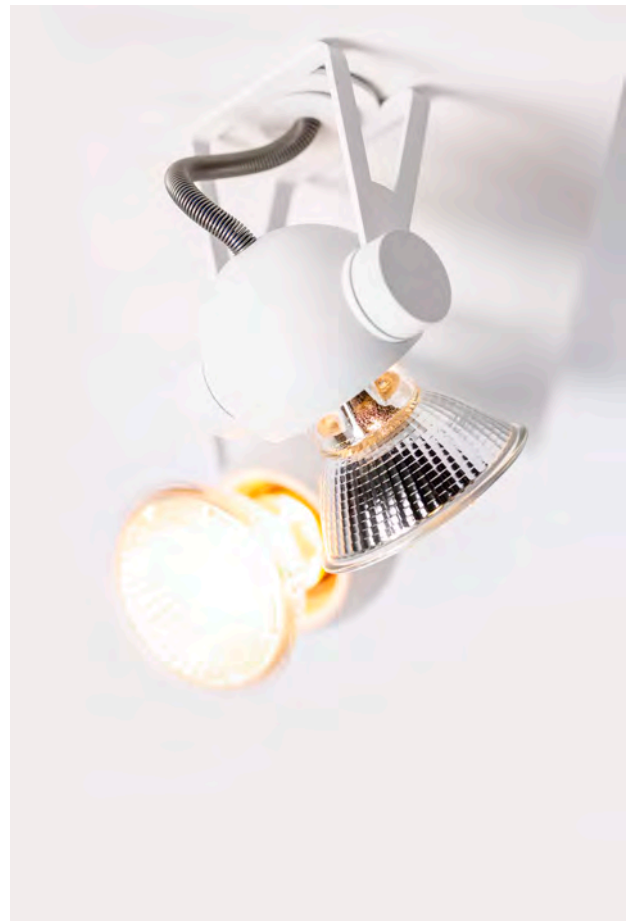

# INDOOR | Ceiling UP | Spots | HI STEP - HI DISCUS

All M10 spotlights and pendants can be combined with bases (built-in & built-up) and Juba bases as preferred.

Alle M10 Aufbaustrahler und Pendelleuchten können mit Rosetten (In- & Aufbau) und Juba Basen nach Wahl kombiniert werden.

## HI.63../.. - STEP 230V - M10



built-up spot M10 - directional  
Aufbaustrahler M10 - schwenkbar

### Lamp type

1x QPAR 51 GU10 max. 20W A+ - E 230V

### Options

- 019 - KNEEJOINT
- 024 - CONNECTOR FOR TRACKS

~230V



### Materials

aluminium 1 | 2 | 11 | 14 | 1M | 2M  
brass 4 | 13 | 16

Colour	HI.6305/.. H 70	HI.6310/.. H 100	HI.6315/.. H 150	HI.6320/.. H 200	HI.6330/.. H 300	HI.6350/.. H 500	HI.6380/.. H 800
1							
1M							
2							
2M							
4							
11							
13							
14							
16							

built-up

SPOTS

## HI.60../.. - DISCUS 230V - M10



built-up spot M10 - directional  
Aufbaustrahler M10 - schwenkbar

### Lamp type

1x QPAR 51 GU10 max. 20W A+ - E 230V

### Options

- 019 - KNEEJOINT
- 024 - CONNECTOR FOR TRACKS

~230V



### Materials

aluminium 1 | 2 | 11 | 14 | 1M | 2M  
brass 4 | 13 | 16

Colour	HI.6005/.. H 70	HI.6010/.. H 100	HI.6015/.. H 150	HI.6020/.. H 200	HI.6030/.. H 300	HI.6050/.. H 500	HI.6080/.. H 800
1							
1M							
2							
2M							
4							
11							
13							
14							
16							

built-up



## INDOOR | Ceiling UP | Spots | HI CAPRI - HI APOLLO

All M10 spotlights and pendants can be combined with bases (built-in & built-up) and Juba bases as preferred.

Alle M10 Aufbaustrahler und Pendelleuchten können mit Rosetten (In- & Aufbau) und Juba Basen nach Wahl kombiniert werden.

### HI.71../.. - CAPRI 230V - M10

~230V



built-up spot M10 - directional  
Aufbaustrahler M10 - schwenkbar

#### Materials

aluminium 1 | 2 | 11 | 14 | 1M | 2M  
brass 4 | 13 | 16

#### Lamp type

1x QPAR 51 GU10 max. 20W A+ - E 230V

#### Options

019 - KNEEJOINT  
024 - CONNECTOR FOR TRACKS

Colour	HI.7105/..	HI.7110/..	HI.7115/..	HI.7120/..	HI.7130/..	HI.7150/..	HI.7180/..
	H 70	H 100	H 150	H 200	H 300	H 500	H 800
1							
1M							
2							
2M							
4							
11							
13							
14							
16							

built-up

### HI.66../.. - APOLLO 230V

~230V



built-up spot M10 - directional  
Aufbaustrahler M10 - schwenkbar

#### Materials

aluminium 14

#### Lamp type

1x QPAR 51 GU10 max. 20W A+ - E 230V

#### Options

019 - KNEEJOINT  
024 - CONNECTOR FOR TRACKS

Colour	HI.6610/..	HI.6615/..	HI.6620/..	HI.6630/..
	H 100	H 150	H 200	H 300
14				

built-up

## INDOOR | Ceiling UP | Spots | FIXER

All M10 spotlights and pendants can be combined with bases (built-in & built-up) and Juba bases as preferred.

Alle M10 Aufbaustrahler und Pendelleuchten können mit Rosetten (In- & Aufbau) und Juba Basen nach Wahl kombiniert werden.

### 7606.ES50/.. - FIXER - M10

~230V



built-up spot M10 - directional - without LED lamp  
Aufbaustrahler M10 - schwenkbar - Ohne LED Lampe

#### Lamp type

1x QPAR 51 GU10 max. 20W A+ - E **230V**

#### Dimensions

L60xB60xH150

Head - L60xB60xH90

#### Materials

aluminium 14 | 1M | 2M | 11M

#### Ref

7606.ES50.1M	white tex
7606.ES50.2M	black tex
7606.ES50.11M	grey tex
7606.ES50.14	alu satin

built-up

### 7603.AC/.. - FIXER

~230V



spotlight - directional - with LED module  
Aufbaustrahler - schwenkbar - mit LED-Modul

#### Lamp type

1x LED AC 700lm CRI92 max. 9,5W A+ **230V**

#### Dimensions

L60xB60xH185 ∧ 38° reflector

Head - L60xB60xH125

#### Ref

7603C.1M	CW   NW   WW
7603C.2M	CW   NW   WW
7603C.14	CW   NW   WW
7603C.45	CW   NW   WW

built-up

dimmable with leading and trailing edge dimmer  
dimmbar mit einem Phasen- und Abschnittdimmer

### 7604.700.DC/.. - FIXER

=250mA



spotlight - directional - with LED module - without LED driver  
Aufbaustrahler - schwenkbar - mit LED-Modul - ohne Driver LED

#### Lamp type

1x LED DC 700lm CRI92 max. 8,8W A+ **250mA**

#### Dimensions

L60xB60xH185 ∧ 36° reflector

Head - L60xB60xH125

#### Ref

7604.700.DC.1M	CW   NW   WW
7604.700.DC.2M	CW   NW   WW
7604.700.DC.14	CW   NW   WW
7604.700.DC.45	CW   NW   WW

built-up

### 7605.1200.DC/.. - FIXER

=350mA



spotlight - directional - with LED module - without LED driver  
Aufbaustrahler - schwenkbar - mit LED-Modul - ohne Driver LED

#### Lamp type

1x LED DC 1200lm CRI92 max. 12,2W A+ **350mA**

#### Dimensions

L60xB60xH185 ∧ 36° reflector

Head - L60xB60xH125

#### Ref

7605.1200.DC.1M	CW   NW   WW
7605.1200.DC.2M	CW   NW   WW
7605.1200.DC.14	CW   NW   WW
7605.1200.DC.45	CW   NW   WW

built-up

All M10 spotlights and pendants can be combined with bases (built-in & built-up) and Juba bases as preferred.

Alle M10 Aufbaustrahler und Pendelleuchten können mit Rosetten (In- & Aufbau) und Juba Basen nach Wahl kombiniert werden.





# INDOOR | Ceiling UP | Spots | FIXER

All M10 spotlights and pendants can be combined with bases (built-in & built-up) and Juba bases as preferred.

Alle M10 Aufbaustrahler und Pendelleuchten können mit Rosetten (In- & Aufbau) und Juba Basen nach Wahl kombiniert werden.

## 7876.XTM/.. - FIXER

=700mA



IP20



0,5 m

05.20.50



built-up spot LED M10 - square - directional - with LED module - without LED driver  
 Aufbaustrahler LED M10 - viereckig - schwenkbar - mit LED-Modul - ohne Driver LED

### Ref

7876.XTM.1M

CW | NW | WW

7876.XTM.2M

CW | NW | WW

### Lamp type

1x Led 1300lm CRI80 max. 9,5W A - A 700mA

### Dimensions

L80xB80xH150  $\wedge$  28° reflector

Head - L80xB80xH90

built-up

SPOTS



All M10 spotlights and pendants can be combined with bases (built-in & built-up) and Juba bases as preferred.

Alle M10 Aufbaustrahler und Pendelleuchten können mit Rosetten (In- & Aufbau) und Juba Basen nach Wahl kombiniert werden.

**4090.IP20/.. - FIXER XICATO**

=500mA



built-up ceiling light - directional - with LED module - without LED driver  
 Aufbau Deckenleuchte - schwenkbar - mit LED-Modul - ohne Driver LED

**Lamp type**  
 1x Led 965lm CRI80 max. 6,6W - 500mA

**Dimensions**  
 L60xB60xH95   
 Reflector - Ø50

Ref	
4090.IP20.1M	NW   WW
4090.IP20.2M	NW   WW
4090.IP20.11M	NW   WW
4090.IP20.14.11	NW   WW

built-up  
 for track systems  
 für Schienensysteme

**4095.IP20/.. - FIXER XICATO**

=700mA



spotlight - directional - with LED module - without LED driver  
 Aufbaustrahler - schwenkbar - mit LED-Modul - ohne Driver LED

**Lamp type**  
 1x Led 1300lm CRI80 max. 9,5W - 700mA

**Dimensions**  
 L80xB80xH95   
 Reflector - Ø70

Ref	
4095.IP20.1M	NW   WW
4095.IP20.2M	NW   WW
4095.IP20.11M	NW   WW
4095.IP20.14.11	NW   WW

built-up  
 for track systems  
 für Schienensysteme

**4100.IP20/.. - FIXER XICATO**

=700mA

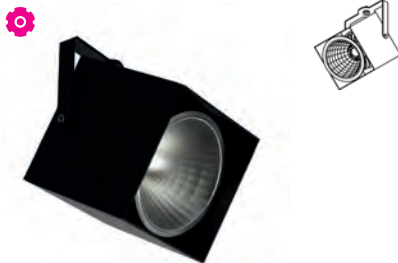

spotlight - directional - with LED module - without LED driver  
 Aufbaustrahler - schwenkbar - mit LED-Modul - ohne Driver LED

**Lamp type**  
 1x Led 2000lm CRI80 max. 15,2W - 700mA

**Dimensions**  
 L120xB120xH95   
 Reflector - Ø111

Ref	
4100.IP20.1M	NW   WW
4100.IP20.2M	NW   WW
4100.IP20.11M	NW   WW
4100.IP20.14.11	NW   WW

built-up  
 3000lm on request  
 3000lm auf Anfrage  
 for track systems  
 für Schienensysteme

SPOTS



## INDOOR | Ceiling UP | Spots | FIXER

All M10 spotlights and pendants can be combined with bases (built-in & built-up) and Juba bases as preferred.

Alle M10 Aufbaustrahler und Pendelleuchten können mit Rosetten (In- & Aufbau) und Juba Basen nach Wahl kombiniert werden.

### 4100.2000.48V/.. - FIXER XICATO 48V

=48V-DC



IP20



0,5 m

05.20.50



built-up spot LED M10 - directional - with LED module - without transformer  
Aufbaustrahler LED M10 - schwenkbar - mit LED-Modul - ohne Trafo

#### Lamp type

1x LED 2000lm CRI80 max. 19,1W A 48V-DC

#### Dimensions

L120xB120xH95  $\wedge$  38° reflector  
Reflector - Ø111

#### Ref

4100.2000.48V.1M	NW   WW
4100.2000.48V.2M	NW   WW
4100.2000.48V.11M	NW   WW
4100.2000.48V.14.11	NW   WW

#### built-up

Dim 1-10V - to combine with adaptor or profile  
zu kombinieren mit einem Adapter oder Profil  
for track systems  
für Schienensysteme

### 4100.3000.48V/.. - FIXER XICATO 48V

=48V-DC



IP20



0,5 m

05.20.50

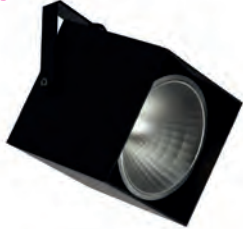

built-up spot LED M10 - directional - with LED module - without transformer  
Aufbaustrahler LED M10 - schwenkbar - mit LED-Modul - ohne Trafo

#### Lamp type

1x LED 3000lm CRI80 max. 31,3W A 48V-DC

#### Dimensions

L120xB120xH95  $\wedge$  38° reflector  
Reflector - Ø111

#### Ref

4100.3000.48V.1M	NW   WW
4100.3000.48V.2M	NW   WW
4100.3000.48V.11M	NW   WW
4100.3000.48V.14.11	NW   WW

#### built-up

Dim 1-10V - to combine with adaptor or profile  
zu kombinieren mit einem Adapter oder Profil  
for track systems  
für Schienensysteme

All M10 spotlights and pendants can be combined with bases (built-in & built-up) and Juba bases as preferred.

Alle M10 Aufbaustrahler und Pendelleuchten können mit Rosetten (In- & Aufbau) und Juba Basen nach Wahl kombiniert werden.

1961.ES50/.. - VOLTA FLEX - M10

~230V



spotlight M10 with flexible tube - directional - base not included  
 Aufbaustrahler M10 mit flexibeler Tube - schwenkbar - ohne Rosette

Lamp type

1x QPAR70 GU10 max. 7W **A+** 230V

Materials

aluminium 11  
 brass 16 | 23

Ref

1961.ES50.11	alu grey
1961.ES50.16	satin gold
1961.ES50.23	dark bronze

built-up

1962.ES50/.. - VOLTA FLEX - M10

~230V



spotlight with flexible tube - directional - without switch  
 Aufbaustrahler mit flexibeler Tube - schwenkbar - ohne Schalter

Lamp type

1x QPAR70 GU10 max. 7W **A+** 230V

Dimensions

Ø60xH415 - Flex 300  
 Base - Ø60xH25  
 Head - Ø80xH90

Materials

aluminium 11 | 2M  
 brass 16 | 23

Ref

1962.ES50.2M	black tex
1962.ES50.11	alu grey
1962.ES50.16	satin gold
1962.ES50.23	dark bronze

built-up



# INDOOR | Ceiling UP | Spots | VOLTA

All M10 spotlights and pendants can be combined with bases (built-in & built-up) and Juba bases as preferred.

Alle M10 Aufbaustrahler und Pendelleuchten können mit Rosetten (In- & Aufbau) und Juba Basen nach Wahl kombiniert werden.

## 1956/.. - VOLTA 12V - M10

~12V   IP20    1,1640 0.5 05.20.02 

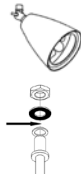

built-up spot M10 - directional - without rod - without transformer  
Aufbaustrahler M10 - schwenkbar - ohne Stange - ohne Trafo

### Lamp type

1x QR-LP70 BA15d max. 50W  -  12V

### Dimensions

Ø78,5xL120

### Materials

aluminium 10 | 14 | 1M | 2M  
brass 13 | 23

### Ref

1956.1M	white tex
1956.2M	black tex
1956.10	alu grey
1956.13	bronze
1956.14	alu satin
1956.23	dark bronze

built-up



## 1956.100/.. - VOLTA 12V - M10

~12V   IP20    2,2760 0.5 05.20.02 



built-up spot M10 - directional - without transformer  
Aufbaustrahler M10 - schwenkbar - ohne Trafo

### Lamp type

1x QR-LP70 BA15d max. 50W  -  12V

### Dimensions

Ø78,5xL90 - Bar 100

### Options

019 - KNEEJOINT  
024 - CONNECTOR FOR TRACKS

### Materials

aluminium 10 | 14 | 1M | 2M  
brass 13 | 23

### Ref

1956.100.1M	white tex
1956.100.2M	black tex
1956.100.10	alu grey
1956.100.13	bronze
1956.100.14	alu satin
1956.100.23	dark bronze

built-up  
other lengths on request  
andere Längen auf Anfrage

## 1956.ES50/.. - VOLTA - M10

~230V  IP20    0.5 05.20.02 



built-up spot M10 - directional - without rod  
Aufbaustrahler M10 - schwenkbar - ohne Stange

### Lamp type

1x QPAR70 GU10 max. 7W  230V

### Dimensions

Ø78,5xL120

### Materials

aluminium 14 | 1M | 2M  
brass 13 | 23

### Ref

1956.ES50.1M	white tex
1956.ES50.2M	black tex
1956.ES50.13	bronze
1956.ES50.14	alu satin
1956.ES50.23	dark bronze

built-up

## 1956.100.ES50/.. - VOLTA - M10

~230V  IP20    0.5 05.20.02 



built-up spot M10 - directional  
Aufbaustrahler M10 - schwenkbar

### Lamp type

1x QPAR70 GU10 max. 7W  230V

### Dimensions

Ø78,5xL90 - 100

### Materials

aluminium 14 | 1M | 2M  
brass 13 | 23

### Ref

1956.100.ES50.1M	white tex
1956.100.ES50.2M	black tex
1956.100.ES50.13	bronze
1956.100.ES50.14	alu satin
1956.100.ES50.23	dark bronze

built-up  
other lengths on request  
andere Längen auf Anfrage



optional: assembly lamps + transformer/driver - not included  
 optional: Montage Leuchtmittel + Trafo/Treiber - nicht einbegriffen

5040/.. - PULA

~12V   IP20    0,5 m  



spotlight - directional - with base 005 - without transformer  
 Aufbaustrahler - schwenkbar - mit Basis 005 - ohne Trafo

**Lamp type**  
 1x QR-LP70 BA15d max. 50W  -  12V

**Dimensions**  
 Ø60xH90

**Materials**  
 aluminium 1M | 2M  
 brass 23

**Ref**  
 5040.1M white tex  
 5040.2M black tex  
 5040.23 dark bronze



built-up

5041/.. - PULA - M10

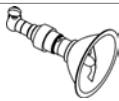
~12V   IP20    0,1500 0,5 m  



spotlight - directional - with kneejoint - without transformer  
 Aufbaustrahler - schwenkbar - mit Kniegelenk - ohne Trafo

**Lamp type**  
 1x QR-LP70 BA15d max. 50W  -  12V

**Dimensions**  
 H65

**Materials**  
 aluminium 1M | 2M  
 brass 7 | 23

**Ref**  
 5041.1M white tex  
 5041.2M black tex  
 5041.7 chrome  
 5041.23 dark bronze



built-up

64../.. - FOLIO 12V - M10

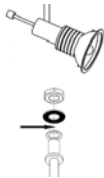
~12V   IP20    0,5 m  



built-up spot M10 - directional - without transformer  
 Aufbaustrahler M10 - schwenkbar - ohne Trafo

**Lamp type**  
 1x QR-LP70 BA15d max. 50W  -  12V

**Options**  
 019 - KNEEJOINT  
 024 - CONNECTOR FOR TRACKS

**Materials**  
 aluminium 1 | 2 | 11 | 14 | 1M | 2M  
 brass 4 | 16 | 23

Colour	6405/..	6410/..	6415/..	6420/..	6430/..	6450/..	6480/..
	H 70	H 100	H 150	H 200	H 300	H 500	H 800
1							
1M							
2							
2M							
4							
11							
14							
16							
23							

built-up



# INDOOR | Ceiling UP | Spots | TORPEDO - UTOPIE

All M10 spotlights and pendants can be combined with bases (built-in & built-up) and Juba bases as preferred.

Alle M10 Aufbaustrahler und Pendelleuchten können mit Rosetten (In- & Aufbau) und Juba Basen nach Wahl kombiniert werden.

## 1494/.. - TORPEDO

~230V



built-in base with built-up spot - directional  
Einbaubasis mit Aufbaustrahler - schwenkbar

### Lamp type

1x QPAR111 GU10 max. 12W **A+** - **D** 230V

### Dimensions

Ø124xH95-170

Ø75 L 40

### Materials

aluminium 14 | 1M | 2M

### Ref

1494.1M

1494.2M

1494.14

white tex

black tex

alu satin

**built-in**  
socle Ø90xH10  
Sockel Ø90xH10

## 62../.. - UTOPIE 12V - M10

~12V



built-up spot M10 - directional - without transformer  
Aufbaustrahler M10 - schwenkbar - ohne Trafo

### Lamp type

1x QR-LP111 G53 max. 50W **A** - **C** 12V

### Options

019 - KNEEJOINT

024 - CONNECTOR FOR TRACKS



Colour	6210/..	6215/..	6220/..	6230/..	6250/..	6280/..
	H 100	H 150	H 200	H 300	H 500	H 800
1						
1M						
2						
2M						
4						
13						
14						
16						

### Materials

aluminium

brass

1 | 2 | 14 | 1M | 2M

4 | 13 | 16

**built-up**



All M10 spotlights and pendants can be combined with bases (built-in & built-up) and Juba bases as preferred.

Alle M10 Aufbaustrahler und Pendelleuchten können mit Rosetten (In- & Aufbau) und Juba Basen nach Wahl kombiniert werden.

1809/././.. - GLOBO 12V - M10

~12V



built-up



built-up spot M10 - directional - without transformer  
Aufbaustrahler M10 - schwenkbar - ohne Trafo

Lamp type

1x QR-LP111 G53 max. 50W A - C 12V

Cone - Ø111xH53,3

Options

019 - KNEEJOINT

Materials

aluminium  
brass

1M | 2M | 11M  
13 | 23



Max. H  
67 mm

Colour	1809.10/..	1809.15/..	1809.20/..	1809.30/..
	H 100	H 150	H 200	H 300
1M				
2M				
11M				
13				
23				



## INDOOR | Ceiling UP | Spots | JAZZ - COCTAIL

All M10 spotlights and pendants can be combined with bases (built-in & built-up) and Juba bases as preferred.

Alle M10 Aufbaustrahler und Pendelleuchten können mit Rosetten (In- & Aufbau) und Juba Basen nach Wahl kombiniert werden.

### 90../.. - JAZZ 12V - M10

~12V



IP20



built-up spot M10 - directional - without transformer  
Aufbaustrahler M10 - schwenkbar - ohne Trafo

#### Materials

aluminium  
brass

1 | 2 | 11 | 1M | 2M  
4 | 13 | 16

#### Lamp type

1x QR-CB 51 GU5,3/GX5,3 max. 50W - 12V

#### Options

015.M6 - KNEEJOINT  
019 - KNEEJOINT  
023.M6 - CONNECTOR FOR TRACKS

Colour	9005/..	9010/..	9015/..	9020/..	9030/..
	H 50	H 100	H 150	H 200	H 300
1					
1M					
2					
2M					
4					
11					
13					
16					

built-up

SPOTS

### 70../.. - COCTAIL 12V - M10

~12V



IP20



built-up spot M10 - without transformer  
Aufbaustrahler M10 - ohne Trafo

#### Materials

aluminium  
brass

1 | 2 | 11 | 1M | 2M  
4 | 13 | 16

#### Lamp type

1x QR-CB 51 GU5,3/GX5,3 max. 50W - 12V

#### Options

015.M6 - KNEEJOINT  
019 - KNEEJOINT  
023.M6 - CONNECTOR FOR TRACKS

Colour	7005/..	7010/..	7015/..	7020/..	7030/..
	H 50	H 100	H 150	H 200	H 300
1					
1M					
2					
2M					
4					
11					
13					
16					







# INDOOR | Ceiling UP | Spots | COLIBRI - TUBA

All M10 spotlights and pendants can be combined with bases (built-in & built-up) and Juba bases as preferred.

Alle M10 Aufbaustrahler und Pendelleuchten können mit Rosetten (In- & Aufbau) und Juba Basen nach Wahl kombiniert werden.

## 80../.. - COLIBRI 12V -M10

~12V

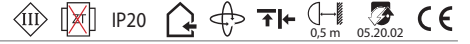

built-up spot M10 - directional - without transformer  
Aufbaustrahler M10 - schwenkbar - ohne Trafo

### Lamptype

1x QR-CB 51 GU5,3/GX5,3 max. 50W A - E 12V

### Options

- 015.M6 - KNEEJOINT
- 019 - KNEEJOINT
- 023.M6 - CONNECTOR FOR TRACKS

### Materials

aluminium  
brass

1 | 2 | 11 | 1M | 2M  
4 | 13 | 16

Colour	8005/..	8010/..	8015/..	8020/..	8030/..
	H 50	H 100	H 150	H 200	H 300
1					
1M					
2					
2M					
4					
11					
13					
16					

built-up

SPOTS

## 50../.. - TUBA 12V - M10

~12V



built-up spot M10 - directional - without transformer  
Aufbaustrahler M10 - schwenkbar - ohne Trafo

### Lamptype

1x QR-CB 51 GU5,3/GX5,3 max. 35W A - E 12V

### Materials

aluminium  
brass

1 | 2 | 11 | 14 | 1M | 2M  
4 | 13 | 16

Colour	5010/..	5020/..	5030/..
	H 100	H 200	H 300
1			
1M			
2			
2M			
4			
11			
13			
14			
16			

built-up  
use coolfit lamp  
Coolfit-Lampe verwenden

# INDOOR | Ceiling UP | Spots | VIOLA - DISCUS

All M10 spotlights and pendants can be combined with bases (built-in & built-up) and Juba bases as preferred.

Alle M10 Aufbaustrahler und Pendelleuchten können mit Rosetten (In- & Aufbau) und Juba Basen nach Wahl kombiniert werden.

## 1960../.. - VIOLA 12V - M10

~12V

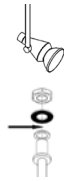

built-up spot M10 - directional - without transformer  
Aufbaustrahler M10 - schwenkbar - ohne Trafo

### Materials

aluminium

14 | 1M | 2M

### Lamp type

1x QR-CB 51 GU5,3/GX5,3 max. 50W A+ - E 12V

### Options

019 - KNEEJOINT

Colour	1960.10/..	1960.15/..	1960.20/..	1960.30/..
	H 100	H 150	H 200	H 300
1M				
2M				
14				

built-up

## 60../.. - DISCUS 12V - M10

~12V

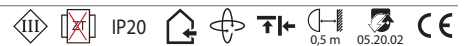

built-up spot M10 - directional - without transformer  
Aufbaustrahler M10 - schwenkbar - ohne Trafo

### Materials

aluminium

1 | 2 | 11 | 14 | 1M | 2M

brass

4 | 13 | 16

### Lamp type

1x QR-CB 51 GU5,3/GX5,3 max. 50W A+ - E 12V

### Options

019 - KNEEJOINT

024 - CONNECTOR FOR TRACKS

Colour	6005/..	6010/..	6015/..	6020/..	6030/..	6050/..	6080/..
	H 50	H 100	H 150	H 200	H 300	H 500	H 800
1							
1M							
2							
2M							
4							
11							
13							
14							
16							

built-up

# INDOOR | Ceiling UP | Spots | DISCOVERY - STEP

All M10 spotlights and pendants can be combined with bases (built-in & built-up) and Juba bases as preferred.

Alle M10 Aufbaustrahler und Pendelleuchten können mit Rosetten (In- & Aufbau) und Juba Basen nach Wahl kombiniert werden.

## 69../.. - DISCOVERY 12V - M10

~12V



built-up spot M10 - directional - without transformer  
Aufbaustrahler M10 - schwenkbar - ohne Trafo

### Materials

aluminium  
brass

1 | 2 | 11 | 14 | 1M | 2M  
4 | 13 | 16

### Lamp type

1x QR-CB 51 GU5,3/GX5,3 max. 35W **A+** - **E** 12V

### Options

019 - KNEEJOINT  
024 - CONNECTOR FOR TRACKS

Colour	6905/..	6910/..	6915/..	6920/..	6930/..
	H 50	H 100	H 150	H 200	H 300
1					
1M					
2					
2M					
4					
11					
13					
14					
16					

**built-up**  
use coolfit lamp  
Coolfit-Lampe verwenden

SPOTS

## 63../.. - STEP 12V - M10 - M10

~12V

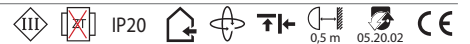

built-up spot M10 - directional - without transformer  
Aufbaustrahler M10 - schwenkbar - ohne Trafo

### Materials

aluminium  
brass

1 | 2 | 11 | 14 | 1M | 2M  
4 | 13 | 16 | 23

### Lamp type

1x QR-CB 51 GU5,3/GX5,3 max. 50W **A+** - **E** 12V

### Options

019 - KNEEJOINT  
024 - CONNECTOR FOR TRACKS

Colour	6305/..	6310/..	6315/..	6320/..	6330/..	6350/..	6380/..
	H 70	H 100	H 150	H 200	H 300	H 500	H 800
1							
1M							
2							
2M							
4							
11							
13							
14							
16							
23							

**built-up**

All M10 spotlights and pendants can be combined with bases (built-in & built-up) and Juba bases as preferred.

Alle M10 Aufbaustrahler und Pendelleuchten können mit Rosetten (In- & Aufbau) und Juba Basen nach Wahl kombiniert werden.

61../.. - DOMINO 12V- M10

~12V



built-up spot M10 - directional - without transformer  
Aufbaustrahler M10 - schwenkbar - ohne Trafo

Materials

aluminium  
brass

1 | 2 | 11 | 14 | 1M | 2M  
4 | 13 | 16

Lamp type

1x QR-CB 51 GU5,3/GX5,3 max. 50W **A+** - **E** 12V

Options

019 - KNEEJOINT  
024 - CONNECTOR FOR TRACKS

Colour	6105/..	6110/..	6115/..	6120/..	6130/..	6150/..	6180/..
	H 70	H 100	H 150	H 200	H 300	H 500	H 800
1							
1M							
2							
2M							
4							
11							
13							
14							
16							

built-up

68../.. - JUPITER 12V - M10

~12V

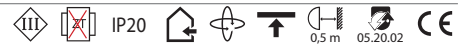

built-up spot M10 - directional - without transformer  
Aufbaustrahler M10 - schwenkbar - ohne Trafo

Materials

aluminium  
brass

1 | 2 | 11 | 14 | 1M | 2M  
4 | 13 | 16

Lamp type

1x QR-CB 51 GU5,3/GX5,3 max. 35W **A+** - **E** 12V

Options

019 - KNEEJOINT  
024 - CONNECTOR FOR TRACKS

Colour	6805/..	6810/..	6815/..	6820/..	6830/..
	H 70	H 100	H 150	H 200	H 300
1					
1M					
2					
2M					
4					
11					
13					
14					
16					

built-up  
use coolfit lamp  
Coolfit-Lampe verwenden



# INDOOR | Ceiling UP | Spots | CAPRI - CONDOR

All M10 spotlights and pendants can be combined with bases (built-in & built-up) and Juba bases as preferred.

Alle M10 Aufbaustrahler und Pendelleuchten können mit Rosetten (In- & Aufbau) und Juba Basen nach Wahl kombiniert werden.

## 71../.. - CAPRI 12V -M10

~12V



built-up spot M10 - directional - without transformer  
Aufbaustrahler M10 - schwenkbar - ohne Trafo

### Materials

aluminium  
brass

1 | 2 | 11 | 14 | 1M | 2M  
4 | 13 | 16

### Lamp type

1x QR-CB 51 GU5,3/GX5,3 max. 50W A+ - E 12V

### Options

019 - KNEEJOINT  
024 - CONNECTOR FOR TRACKS

Colour	7105/..	7110/..	7115/..	7120/..	7130/..
	H 70	H 100	H 150	H 200	H 300
1					
1M					
2					
2M					
4					
11					
13					
14					
16					

built-up

SPOTS

## 72../.. - CONDOR 12V -M10

~12V



built-up spot M10 - directional - without transformer  
Aufbaustrahler M10 - schwenkbar - ohne Trafo

### Materials

aluminium  
brass

1 | 2 | 11 | 14 | 1M | 2M  
4 | 13 | 16

### Lamp type

1x QR-CB 51 GU5,3/GX5,3 max. 50W A+ - E 12V

### Options

019 - KNEEJOINT  
024 - CONNECTOR FOR TRACKS

Colour	7205/..	7210/..	7215/..	7220/..	7230/..
	H 70	H 100	H 150	H 200	H 300
1					
1M					
2					
2M					
4					
11					
13					
14					
16					

built-up

All M10 spotlights and pendants can be combined with bases (built-in & built-up) and Juba bases as preferred.

Alle M10 Aufbaustrahler und Pendelleuchten können mit Rosetten (In- & Aufbau) und Juba Basen nach Wahl kombiniert werden.

**3004.DISCUS.ES50/.. - COMMA 230V - M10**

~230V



built-up spot M10 - directional  
Aufbaustrahler M10 - schwenkbar

**Lamp type**

1x QPAR 51 GU10 max. 20W A+ - E **230V**

**Dimensions**

Ø51xH455 - 500

**Materials**

aluminium 1 | 2 | 11 | 14 | 1M | 2M  
brass 4 | 13 | 16

**Ref**

3004.DISCUS.ES50.1	white
3004.DISCUS.ES50.1M	white tex
3004.DISCUS.ES50.2	black
3004.DISCUS.ES50.2M	black tex
3004.DISCUS.ES50.4	shiny gold
3004.DISCUS.ES50.11	alu grey
3004.DISCUS.ES50.13	bronze
3004.DISCUS.ES50.14	alu satin
3004.DISCUS.ES50.16	satin gold

**built-up**

standard 500mm - 200-300-400mm on request  
standard 500mm - 200-300-400mm auf Anfrage

**3004.STEP.ES50/.. - COMMA 230V - M10**

~230V



built-up spot M10 - directional  
Aufbaustrahler M10 - schwenkbar

**Lamp type**

1x QPAR 51 GU10 max. 20W A+ - E **230V**

or 1x QPAR70 GU10 max. 7W A+ **230V**

**Dimensions**

Ø51xH455 - 500

**Materials**

aluminium 1 | 2 | 11 | 14 | 1M | 2M | 11M  
brass 4 | 13 | 16

**Ref**

3004.STEP.ES50.1	white
3004.STEP.ES50.1M	white tex
3004.STEP.ES50.2	black
3004.STEP.ES50.2M	black tex
3004.STEP.ES50.4	shiny gold
3004.STEP.ES50.11	alu grey
3004.STEP.ES50.11M	grey tex
3004.STEP.ES50.13	bronze
3004.STEP.ES50.14	alu satin
3004.STEP.ES50.16	satin gold

**built-up**

standard 500mm - 200-300-400mm on request  
standard 500mm - 200-300-400mm auf Anfrage



## INDOOR | Ceiling UP | Spots | COMMA

All M10 spotlights and pendants can be combined with bases (built-in & built-up) and Juba bases as preferred.

Alle M10 Aufbaustrahler und Pendelleuchten können mit Rosetten (In- & Aufbau) und Juba Basen nach Wahl kombiniert werden.

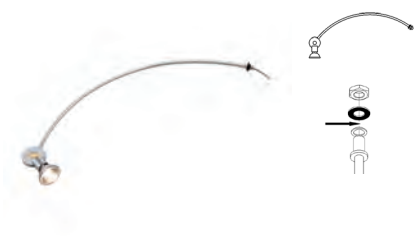

### 3004.DISCUS/.. - COMMA 12V - M10

~12V   IP20     0,3300  0,5 m  05.20.02 



built-up spot M10 - directional - without transformer  
Aufbaustrahler M10 - schwenkbar - ohne Trafo

#### Lamp type

1x QR-CB 51 GU5,3/GX5,3 max. 50W  -  12V

#### Dimensions

Ø51xH455 - Bar 500

#### Materials

aluminium 1 | 2 | 11 | 14 | 2M  
brass 4 | 13 | 16

#### Ref

3004.DISCUS.1	white
3004.DISCUS.2	black
3004.DISCUS.2M	black tex
3004.DISCUS.4	shiny gold
3004.DISCUS.11	alu grey
3004.DISCUS.13	bronze
3004.DISCUS.14	alu satin
3004.DISCUS.16	satin gold

#### built-up

standard 500mm - 200-300-400mm on request  
standard 500mm - 200-300-400mm auf Anfrage

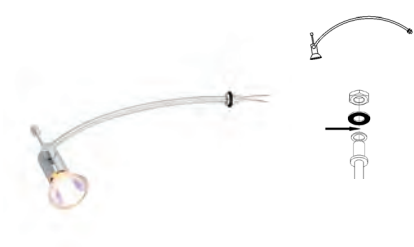

### 3004.STEP/.. - COMMA 12V - M10

~12V   IP20     0,2320  0,5 m  05.20.02 



built-up spot M10 - directional - without transformer  
Aufbaustrahler M10 - schwenkbar - ohne Trafo

#### Lamp type

1x QR-CB 51 GU5,3/GX5,3 max. 50W  -  12V

#### Dimensions

Ø51xH455 - Bar 500

#### Materials

aluminium 1 | 2 | 11 | 14  
brass 4 | 13 | 16

#### Ref

3004.STEP.1	white
3004.STEP.2	black
3004.STEP.4	shiny gold
3004.STEP.11	alu grey
3004.STEP.13	bronze
3004.STEP.14	alu satin
3004.STEP.16	satin gold

#### built-up

standard 500mm - 200-300-400mm on request  
standard 500mm - 200-300-400mm auf Anfrage

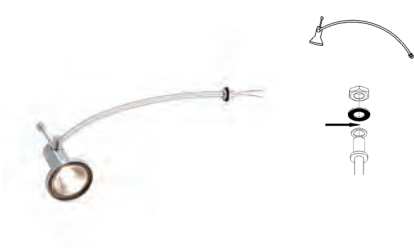

### 3004.JUPITER/.. - COMMA 12V - M10

~12V   IP20     0,3200  0,5 m  05.20.02 



built-up spot M10 - directional - without transformer  
Aufbaustrahler M10 - schwenkbar - ohne Trafo

#### Lamp type

1x QR-CB 51 GU5,3/GX5,3 max. 35W  -  12V

#### Dimensions

Ø51xH455 - Bar 500

#### Materials

aluminium 1 | 2 | 11 | 14 | 2M  
brass 4 | 13 | 16

#### Ref

3004.JUPITER.1	white
3004.JUPITER.2	black
3004.JUPITER.2M	black tex
3004.JUPITER.4	shiny gold
3004.JUPITER.11	alu grey
3004.JUPITER.13	bronze
3004.JUPITER.14	alu satin
3004.JUPITER.16	satin gold

#### built-up

standard 500mm - 200-300-400mm on request - use  
coolfit lamp  
standard 500mm - 200-300-400mm auf Anfrage -  
Coolfit-Lampe verwenden

All M10 spotlights and pendants can be combined with bases (built-in & built-up) and Juba bases as preferred.

Alle M10 Aufbaustrahler und Pendelleuchten können mit Rosetten (In- & Aufbau) und Juba Basen nach Wahl kombiniert werden.

**4002/././.. - FLEX**

~12V



IP20



0,5 m



flexible tube for pendant - directional - only for G4 - without transformer  
 flexible Tube für Pendelleuchte - schwenkbar - nur für G4 - ohne Trafo

**Materials**  
 aluminium  
 brass

11  
 16

**Lamptype**

1x QT9-ax G4 max. 20W A - E 12V

Colour	4002.300/..	4002.400/..	4002.500/..	4002.600/..	4002.800/..
	H 300	H 400	H 500	H 600	H 800
11					
16					

*built-up*



SPOTS

## INDOOR | Ceiling UP | Spots | FLEX - ORKA

All M10 spotlights and pendants can be combined with bases (built-in & built-up) and Juba bases as preferred.

Alle M10 Aufbaustrahler und Pendelleuchten können mit Rosetten (In- & Aufbau) und Juba Basen nach Wahl kombiniert werden.

### 3990.300/.. - FLEX LITTLE CAPA - M10

~230V



spotlight with flexible tube - directional - without switch  
Aufbaustrahler mit flexibler Tube - schwenkbar - ohne Schalter

#### Lamp type

1x QPAR 51 GU10 max. 20W A+ - E 230V

or 1x QPAR70 GU10 max. 7W A+ 230V

Base - Ø60xH25

Head - Ø33xH43

#### Materials

aluminium 11 | 1M | 2M

#### Ref

3990.300.1M

white tex

3990.300.2M

black tex

3990.300.11

alu grey

built-up

### 3023/..../.. - ORKA M10

=700mA



built-up spotlight LED M10 with flexible tube - directional - down - without LED driver

Aufbaustrahler LED M10 mit flexibler Tube - schwenkbar - down - ohne Driver LED

#### Lamp type

1x powered 700mA max. 3W A+ - A+ 700mA

#### Dimensions

Ø50  $\wedge$  40° reflector

Colour	3023.300/..	3023.400/..	3023.500/..
	H 300	H 400	H 500
10.CW			
10.WW			
14.CW			
14.WW			

#### Materials

aluminium

10 | 14

built-up

other °angle reflector on demand  
andere °Winkel Reflektor auf Anfrage

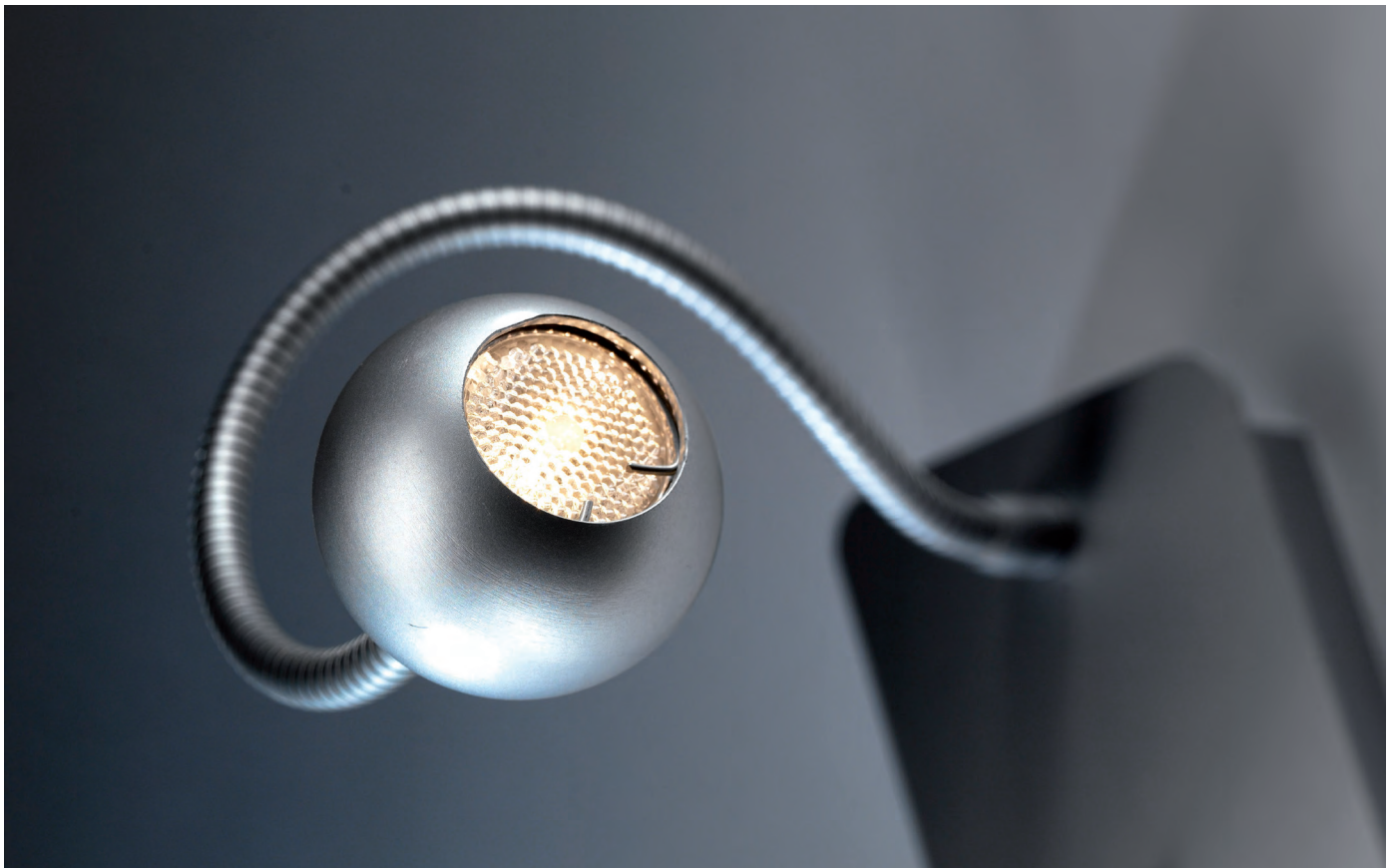



LED colours: cold white (CW) or warm white (WW) - other LED colours on request

LED Farben: kalt Weiß (CW) oder warm Weiß (WW) - andere LED Farben auf Anfrage

**3088.1W/.. - ORKA (43M)**

=350mA



downlight with swivel - directional - down - without LED driver  
Einbaustrahler mit Kugelgelenk - schwenkbar - down - ohne Driver LED

**Lamp type**  
1x powered 350mA max. 1,2W - 350mA

**Dimensions**  
Ø50xD53 40° reflector  
Ø40

**Materials**  
aluminium 14 | 1M | 2M

Ref	
3088.1W.1M.B	white tex
3088.1W.1M.CW	white tex
3088.1W.2M.B	black tex
3088.1W.2M.CW	black tex
3088.1W.14.B	alu satin
3088.1W.14.CW	alu satin
3088.1W.14.NW	alu satin

semi built-in/up  
available as long as supplies last  
verfügbar solange die Vorräte reichen

**3088.3W/.. - ORKA (43M)**

=700mA



downlight with swivel - directional - down - without LED driver  
Einbaustrahler mit Kugelgelenk - schwenkbar - down - ohne Driver LED

**Lamp type**  
1x powered 700mA max. 3W - 700mA

**Dimensions**  
Ø50xD53 40° reflector  
Ø40

**Materials**  
aluminium 14 | 1M | 2M

Ref	
3088.3W.1M.CW	white tex
3088.3W.1M.WW	white tex
3088.3W.2M.CW	black tex
3088.3W.2M.WW	black tex
3088.3W.14.CW	alu satin
3088.3W.14.WW	alu satin

semi built-in/up

**6500/.. - TWIST 12V - B3**

~12V



built-up spot with swivel - directional - without transformer  
Aufbaustrahler mit Kugelgelenk - schwenkbar - ohne Trafo

**Lamp type**  
1x QR-CB 51 GU5,3/GX5,3 max. 50W - 12V

**Options**  
33M10 - ZIA BASE Ø30  
43M10 - ZIA BASE Ø39-40

**Materials**  
aluminium 1 | 2 | 11 | 14  
brass 4 | 13 | 16

Ref	
6500.1	white
6500.2	black
6500.4	shiny gold
6500.11	alu grey
6500.13	bronze
6500.14	alu satin
6500.16	satin gold

built-up  
to combine with 33M or 43M  
zu kombinieren mit 33M oder 43M

# INDOOR PENDANTS

# Index

## A

ANGELO 200-202

## B

BACCHUS 230-232

BACH 228

## C

CAKE 309

CAPA 297

CAPA X 297

CIMBALO 311-312

CLARA 289-296

CLEO 272-274

C-LINE 204

## F

FARFALLE 206

FLEX 326

FLOU 229

## G

GALAXY 199

GALAXY WHEEL 199

GLASS 329-331

GOTA 355

GUILIA 300-301

## H

HANGOVER 307

## J

JACOB 223-227

## L

LUNA 303

## M

MAESTRO 189-191

MAESTRO CARET 185-186

MAESTRO E40 188

MAESTRO SHADE 193-197

MAESTRO SPIN 192

MANON 238-243

MAX 325

MAXI 325

MERO 207-221

MOBY 260-269

MONA 244

MONA LISA 245-246

## N

NAOMI 322-324

NOA 304-306

NOTRE DAME 308

## O

OLIVIA 317-319

OLIVIA MINI 315-316

OPERA 333-334

ORKA 9 328

## P

PIVA 329-332

POLINA 234

POLO 336-344

## R

ROCKY 309-310

## S

SHAKE 275-286

SKIVVE 203

SPACE 321

SPAZIO LED 236

## T

TALLY 298-299

TAVOLO 345-354

TONDO 297

TUBA 321

TWIPE 320

## Z

ZUMBA 320



All M10 spotlights and pendants can be combined with bases (built-in & built-up) and Juba bases as preferred.

Alle M10 Aufbaustrahler und Pendelleuchten können mit Rosetten (In- & Aufbau) und Juba Basen nach Wahl kombiniert werden.

**5003A.1/.. - MAESTRO - TX** ~230V IP20 1 m 0,2200 0,5 m 05.20.02 CE



pendant - with 1m textile cable and strain relief on lampholder's side  
Pendelleuchte - mit 1m Textilkabel und Zugentlastung an Fassung

**Lamp type**  
1x A60 E27 max. 10,5W **A** - **E** 230V

**Dimensions**  
Ø45xH60 - Cable 1000



**Options**  
P040 - STRAIN RELIEF - TREKONTLASTING

**Materials**  
aluminium 14 | 1M | 2M  
brass 4 | 13 | 16 | 23  
red copper 28

**Ref**  
5003A.1.1M.TX1 white tex  
5003A.1.2M.TX2 black tex  
5003A.1.2M.TX3 black tex  
5003A.1.4.TX4 shiny gold  
5003A.1.13.TX8 bronze  
5003A.1.14.TX11 alu satin  
5003A.1.16.TX4 satin gold  
5003A.1.16.TXM satin gold  
5003A.1.23.TX23 dark bronze  
5003A.1.28.TX8 rosé  
5003A.1.28.TXRK rosé

*built-up*

**5003A.2/.. - MAESTRO - TX** ~230V IP20 2 m 0,3500 0,5 m 05.20.02 CE

pendant - with 2m textile cable and strain relief on lampholder's side  
Pendelleuchte - mit 2m Textilkabel und Zugentlastung an Fassung

**Lamp type**  
1x A60 E27 max. 10,5W **A** - **E** 230V

**Dimensions**  
Ø45xH60 - Cable 2000



**Options**  
P040 - STRAIN RELIEF - TREKONTLASTING

**Materials**  
aluminium 14 | 1M | 2M  
brass 4 | 13 | 16 | 23  
red copper 28

**Ref**  
5003A.2.1M.TX1 white tex  
5003A.2.2M.TX2 black tex  
5003A.2.2M.TX3 black tex  
5003A.2.4.TX4 shiny gold  
5003A.2.13.TX8 bronze  
5003A.2.14.TX11 alu satin  
5003A.2.16.TX1 satin gold  
5003A.2.16.TX4 satin gold  
5003A.2.16.TXM satin gold  
5003A.2.23.TX23 dark bronze  
5003A.2.28.TX8 rosé  
5003A.2.28.TXRK rosé

*built-up*

**5003A.3/.. - MAESTRO - TX** ~230V IP20 3 m 0,4500 0,5 m 05.20.02 CE

pendant - with 3m textile cable and strain relief on lampholder's side  
Pendelleuchte - mit 3m Textilkabel und Zugentlastung an Fassung

**Lamp type**  
1x A60 E27 max. 10,5W **A** - **E** 230V

**Dimensions**  
Ø45xH60 - Cable 3000



**Options**  
P040 - STRAIN RELIEF - TREKONTLASTING

**Materials**  
aluminium 14 | 1M | 2M  
brass 4 | 13 | 16 | 23  
red copper 28

**Ref**  
5003A.3.1M.TX1 white tex  
5003A.3.2M.TX2 black tex  
5003A.3.2M.TX3 black tex  
5003A.3.4.TX4 shiny gold  
5003A.3.13.TX8 bronze  
5003A.3.14.TX11 alu satin  
5003A.3.16.TX4 satin gold  
5003A.3.16.TXM satin gold  
5003A.3.23.TX23 dark bronze  
5003A.3.28.TX8 rosé  
5003A.3.28.TXRK rosé

*built-up*

**5003A.4/.. - MAESTRO - TX** ~230V IP20 4 m 0,3600 0,5 m 05.20.02 CE

pendant - with 4m textile cable and strain relief on lampholder's side  
Pendelleuchte - mit 4m Textilkabel und Zugentlastung an Fassung

**Lamp type**  
1x A60 E27 max. 10,5W **A** - **E** 230V

**Dimensions**  
Ø45xH60 - Cable 4000

**Options**  
P040 - STRAIN RELIEF - TREKONTLASTING

**Materials**  
aluminium 14 | 1M | 2M  
brass 4 | 13 | 16 | 23  
red copper 28

**Ref**  
5003A.4.1M.TX1 white tex  
5003A.4.2M.TX2 black tex  
5003A.4.2M.TX3 black tex  
5003A.4.4.TX4 shiny gold  
5003A.4.13.TX8 bronze  
5003A.4.14.TX11 alu satin  
5003A.4.16.TX4 satin gold  
5003A.4.16.TXM satin gold  
5003A.4.23.TX23 dark bronze  
5003A.4.28.TX8 rosé  
5003A.4.28.TXRK rosé

*built-up*



# INDOOR | Ceiling UP | Pendants | MAESTRO

All M10 spotlights and pendants can be combined with bases (built-in & built-up) and Juba bases as preferred.

Alle M10 Aufbaustrahler und Pendelleuchten können mit Rosetten (In- & Aufbau) und Juba Basen nach Wahl kombiniert werden.

PENDANTS

## 5003B.1/.. - MAESTRO - TXW

~230V IP20 1 m 0,1600 0,5 m 05.20.02 CE



pendant - with 1m twisted textile cable and strain relief on lampholder's side  
 Pendelleuchte - mit 1m verdrehtem Textilkabel und Zugentlastung an Fassung

**Lamp type**  
 1x A60 E27 max. 10,5W A - E 230V

**Dimensions**  
 Ø45xH60 - Cable 1000

**Options**  
 P040 - STRAIN RELIEF - TREKONTLASTING

**Materials**  
 aluminium 14 | 1M | 2M  
 brass 4 | 13 | 16 | 23

Ref	
5003B.1.1M.TXW1	white tex
5003B.1.2M.TXW2	black tex
5003B.1.2M.TXW3	black tex
5003B.1.4.TXW4	shiny gold
5003B.1.13.TXW8	bronze
5003B.1.14.TXW11	alu satin
5003B.1.16.TXW4	satin gold
5003B.1.23.TXW23	dark bronze

built-up

## 5003B.2/.. - MAESTRO - TX

~230V IP20 2 m 0,1700 0,5 m 05.20.02 CE



pendant - with 2m twisted textile cable and strain relief on lampholder's side  
 Pendelleuchte - mit 2m verdrehtem Textilkabel und Zugentlastung an Fassung

**Lamp type**  
 1x A60 E27 max. 10,5W A - E 230V

**Dimensions**  
 Ø45xH60 - Cable 2000

**Options**  
 P040 - STRAIN RELIEF - TREKONTLASTING

**Materials**  
 aluminium 14 | 1M | 2M  
 brass 4 | 13 | 16 | 23

Ref	
5003B.2.1M.TXW1	white tex
5003B.2.2M.TXW2	black tex
5003B.2.2M.TXW3	black tex
5003B.2.4.TXW4	shiny gold
5003B.2.13.TXW8	bronze
5003B.2.14.TXW11	alu satin
5003B.2.16.TXW4	satin gold
5003B.2.23.TXW23	dark bronze

built-up

## 5003B.3/.. - MAESTRO - TX

~230V IP20 3 m 0,2200 0,5 m 05.20.02 CE



pendant - with 3m twisted textile cable and strain relief on lampholder's side  
 Pendelleuchte - mit 3m verdrehtem Textilkabel und Zugentlastung an Fassung

**Lamp type**  
 1x A60 E27 max. 10,5W A - E 230V

**Dimensions**  
 Ø45xH60 - Cable 3000

**Options**  
 P040 - STRAIN RELIEF - TREKONTLASTING

**Materials**  
 aluminium 14 | 1M | 2M  
 brass 4 | 13 | 16 | 23

Ref	
5003B.3.1M.TXW1	white tex
5003B.3.2M.TXW2	black tex
5003B.3.2M.TXW3	black tex
5003B.3.4.TXW4	shiny gold
5003B.3.13.TXW8	bronze
5003B.3.14.TXW11	alu satin
5003B.3.16.TXW4	satin gold
5003B.3.23.TXW23	dark bronze

built-up

## 5003B.4/.. - MAESTRO - TX

~230V IP20 4 m 0,4000 0,5 m 05.20.02 CE



pendant - with 4m twisted textile cable and strain relief on lampholder's side  
 Pendelleuchte - mit 4m verdrehtem Textilkabel und Zugentlastung an Fassung

**Lamp type**  
 1x A60 E27 max. 10,5W A - E 230V

**Dimensions**  
 Ø45xH60 - Cable 4000

**Options**  
 P040 - STRAIN RELIEF - TREKONTLASTING

**Materials**  
 aluminium 14 | 1M | 2M  
 brass 4 | 13 | 16 | 23

Ref	
5003B.4.1M.TXW1	white tex
5003B.4.2M.TXW2	black tex
5003B.4.2M.TXW3	black tex
5003B.4.4.TXW4	shiny gold
5003B.4.13.TXW8	bronze
5003B.4.14.TXW11	alu satin
5003B.4.16.TXW4	satin gold
5003B.4.23.TXW23	dark bronze

built-up

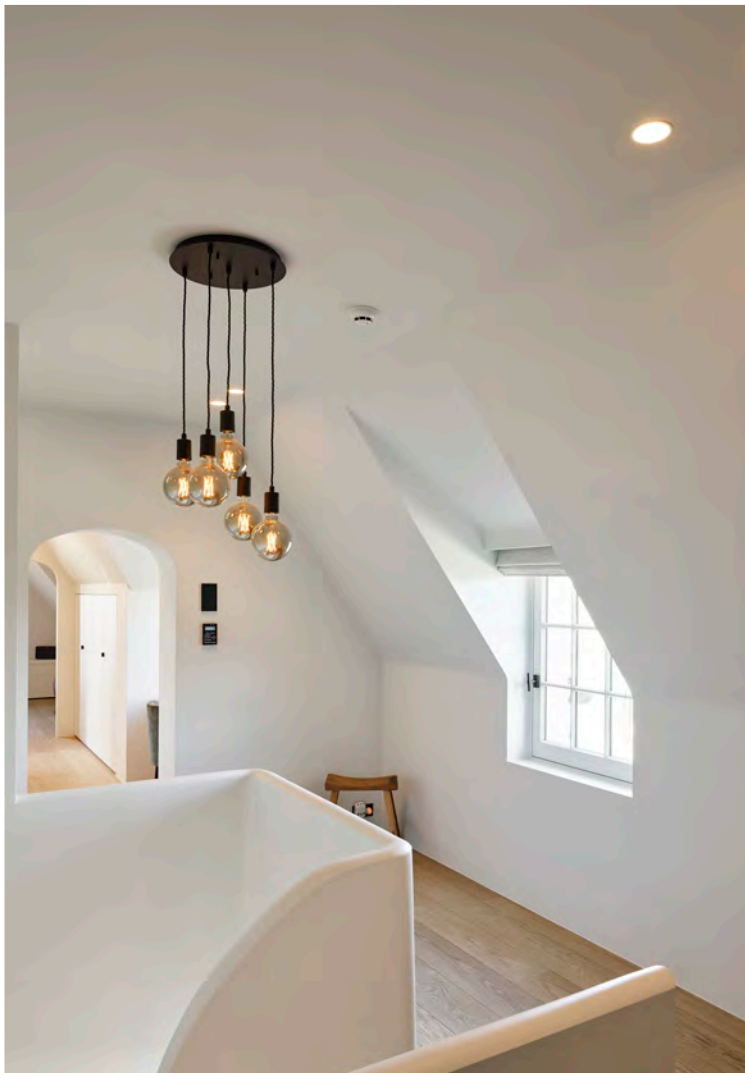

# INDOOR | Ceiling UP | Pendants | MAESTRO

All M10 spotlights and pendants can be combined with bases (built-in & built-up) and Juba bases as preferred.

Alle M10 Aufbaustrahler und Pendelleuchten können mit Rosetten (In- & Aufbau) und Juba Basen nach Wahl kombiniert werden.

PENDANTS

## 5003E.1/.. - MAESTRO - TX

~230V IP20 1 m 0,1800 0,5 m 05.20.02 CE



pendant - with 1m textile cable and strain relief on lampholder's side  
 Pendelleuchte - mit 1m Textilkabel und Zugentlastung an Fassung

**Lamp type**  
 1x A60 E27 max. 10,5W A - E 230V

**Dimensions**  
 Ø45xH60 - Cable 1000

**Options**  
 P040 - STRAIN RELIEF - TREKONTLASTING

**Materials**  
 aluminium 14 | 1M | 2M  
 brass 4 | 13 | 16 | 23  
 red copper 28

Ref	
5003E.1.1M.TX1	white tex
5003E.1.2M.TX2	black tex
5003E.1.2M.TX3	black tex
5003E.1.4.TX4	shiny gold
5003E.1.13.TX8	bronze
5003E.1.14.TX11	alu satin
5003E.1.16.TX4	satin gold
5003E.1.16.TXM	satin gold
5003E.1.23.TX23	dark bronze
5003E.1.28.TX8	rosé
5003E.1.28.TXRK	rosé

built-up

## 5003E.2/.. - MAESTRO - TX

~230V IP20 2 m 0,3500 0,5 m 05.20.02 CE



pendant - with 2m textile cable and strain relief on lampholder's side  
 Pendelleuchte - mit 2m Textilkabel und Zugentlastung an Fassung

**Lamp type**  
 1x A60 E27 max. 10,5W A - E 230V

**Dimensions**  
 Ø45xH60 - Cable 2000

**Options**  
 P040 - STRAIN RELIEF - TREKONTLASTING

**Materials**  
 aluminium 14 | 1M | 2M  
 brass 4 | 13 | 16 | 23  
 red copper 28

Ref	
5003E.2.1M.TX1	white tex
5003E.2.2M.TX2	black tex
5003E.2.2M.TX3	black tex
5003E.2.4.TX4	shiny gold
5003E.2.13.TX8	bronze
5003E.2.14.TX11	alu satin
5003E.2.16.TX4	satin gold
5003E.2.16.TXM	satin gold
5003E.2.23.TX23	dark bronze
5003E.2.28.TX8	rosé
5003E.2.28.TXRK	rosé

built-up

## 5003E.3/.. - MAESTRO - TX

~230V IP20 3 m 0,4000 0,5 m 05.20.02 CE



pendant - with 3m textile cable and strain relief on lampholder's side  
 Pendelleuchte - mit 3m Textilkabel und Zugentlastung an Fassung

**Lamp type**  
 1x A60 E27 max. 10,5W A - E 230V

**Dimensions**  
 Ø45xH60 - Cable 3000

**Options**  
 P040 - STRAIN RELIEF - TREKONTLASTING

**Materials**  
 aluminium 14 | 1M | 2M  
 brass 4 | 13 | 16 | 23  
 red copper 28

Ref	
5003E.3.1M.TX1	white tex
5003E.3.2M.TX2	black tex
5003E.3.2M.TX3	black tex
5003E.3.4.TX4	shiny gold
5003E.3.13.TX8	bronze
5003E.3.14.TX11	alu satin
5003E.3.16.TX4	satin gold
5003E.3.16.TXM	satin gold
5003E.3.23.TX23	dark bronze
5003E.3.28.TX8	rosé
5003E.3.28.TXRK	rosé

built-up

## 5003E.4/.. - MAESTRO - TX

~230V IP20 4 m 0,4500 0,5 m 05.20.02 CE



pendant - with 4m textile cable and strain relief on lampholder's side  
 Pendelleuchte - mit 4m Textilkabel und Zugentlastung an Fassung

**Lamp type**  
 1x A60 E27 max. 10,5W A - E 230V

**Dimensions**  
 Ø45xH60 - Cable 4000

**Options**  
 P040 - STRAIN RELIEF - TREKONTLASTING

**Materials**  
 aluminium 14 | 1M | 2M  
 brass 4 | 13 | 16 | 23  
 red copper 28

Ref	
5003E.4.1M.TX1	white tex
5003E.4.2M.TX2	black tex
5003E.4.2M.TX3	black tex
5003E.4.4.TX4	shiny gold
5003E.4.13.TX8	bronze
5003E.4.14.TX11	alu satin
5003E.4.16.TX4	satin gold
5003E.4.16.TXM	satin gold
5003E.4.23.TX23	dark bronze
5003E.4.28.TX8	rosé
5003E.4.28.TXRK	rosé

built-up



All M10 spotlights and pendants can be combined with bases (built-in & built-up) and Juba bases as preferred.

Alle M10 Aufbaustrahler und Pendelleuchten können mit Rosetten (In- & Aufbau) und Juba Basen nach Wahl kombiniert werden.

**5003F.1/.. - MAESTRO - TXW** ~230V IP20 1m 0,5 m 05.20.02 CE



pendant - with 1m twisted textile cable and strain relief on lampholder's side  
 Pendelleuchte - mit 1m verdrehtem Textilkabel und Zugentlastung an Fassung

**Lamp type**  
 1x A60 E27 max. 10,5W **A** - **E** 230V

**Dimensions**  
 Ø45xH60 - Cable 1000

**Options**  
 P040 - STRAIN RELIEF - TREKONTLASTING

**Materials**  
 aluminium 14 | 1M | 2M  
 brass 4 | 13 | 16 | 23

**Ref**  
 5003F.1.1M.TXW1 white tex  
 5003F.1.2M.TXW2 black tex  
 5003F.1.2M.TXW3 black tex  
 5003F.1.4.TXW4 shiny gold  
 5003F.1.13.TXW8 bronze  
 5003F.1.14.TXW11 alu satin  
 5003F.1.16.TXW4 satin gold  
 5003F.1.23.TXW23 dark bronze

*built-up*

**5003F.2/.. - MAESTRO - TX** ~230V IP20 2m 0,2000 0,5 m 05.20.02 CE



pendant - with 2m twisted textile cable and strain relief on lampholder's side  
 Pendelleuchte - mit 2m verdrehtem Textilkabel und Zugentlastung an Fassung

**Lamp type**  
 1x A60 E27 max. 10,5W **A** - **E** 230V

**Dimensions**  
 Ø45xH60 - Cable 2000

**Options**  
 P040 - STRAIN RELIEF - TREKONTLASTING

**Materials**  
 aluminium 14 | 1M | 2M  
 brass 4 | 13 | 16 | 23  
 red copper 28

**Ref**  
 5003F.2.1M.TXW1 white tex  
 5003F.2.2M.TXW2 black tex  
 5003F.2.2M.TXW3 black tex  
 5003F.2.4.TXW4 shiny gold  
 5003F.2.13.TXW8 bronze  
 5003F.2.14.TXW11 alu satin  
 5003F.2.16.TXW4 satin gold  
 5003F.2.23.TXW23 dark bronze  
 5003F.2.28.TXW2 rosé

*built-up*

**5003F.3/.. - MAESTRO - TX** ~230V IP20 3m 0,5 m 05.20.02 CE



pendant - with 3m twisted textile cable and strain relief on lampholder's side  
 Pendelleuchte - mit 3m verdrehtem Textilkabel und Zugentlastung an Fassung

**Lamp type**  
 1x A60 E27 max. 10,5W **A** - **E** 230V

**Dimensions**  
 Ø45xH60 - Cable 3000

**Options**  
 P040 - STRAIN RELIEF - TREKONTLASTING

**Materials**  
 aluminium 14 | 1M | 2M  
 brass 4 | 13 | 16 | 23  
 red copper 28

**Ref**  
 5003F.3.1M.TXW1 white tex  
 5003F.3.2M.TXW2 black tex  
 5003F.3.2M.TXW3 black tex  
 5003F.3.4.TXW4 shiny gold  
 5003F.3.13.TXW8 bronze  
 5003F.3.14.TXW11 alu satin  
 5003F.3.16.TXW4 satin gold  
 5003F.3.23.TXW23 dark bronze  
 5003F.3.28.TXW2 rosé

*built-up*

**5003F.4/.. - MAESTRO - TX** ~230V IP20 4m 0,5 m 05.20.02 CE



pendant - with 4m twisted textile cable and strain relief on lampholder's side  
 Pendelleuchte - mit 4m verdrehtem Textilkabel und Zugentlastung an Fassung

**Lamp type**  
 1x A60 E27 max. 10,5W **A** - **E** 230V

**Dimensions**  
 Ø45xH60 - Cable 4000

**Options**  
 P040 - STRAIN RELIEF - TREKONTLASTING

**Materials**  
 aluminium 14 | 1M | 2M  
 brass 4 | 13 | 16 | 23  
 red copper 28

**Ref**  
 5003F.4.1M.TXW1 white tex  
 5003F.4.2M.TXW2 black tex  
 5003F.4.2M.TXW3 black tex  
 5003F.4.4.TXW4 shiny gold  
 5003F.4.13.TXW8 bronze  
 5003F.4.14.TXW11 alu satin  
 5003F.4.16.TXW4 satin gold  
 5003F.4.23.TXW23 dark bronze  
 5003F.4.28.TXW2 rosé

*built-up*

# INDOOR | Ceiling UP | Pendants | MAESTRO

All M10 spotlights and pendants can be combined with bases (built-in & built-up) and Juba bases as preferred.

Alle M10 Aufbaustrahler und Pendelleuchten können mit Rosetten (In- & Aufbau) und Juba Basen nach Wahl kombiniert werden.

PENDANTS

## 5016.1/.. - MAESTRO - TX

~230V



pendant - with 1m textile cable and strain relief on lampholder's side  
 Pendelleuchte - mit 1m Textilkabel und Zugentlastung an Fassung

### Lamptype

1x A60 E27 max. 10,5W A - E 230V

### Dimensions

Ø45xH110 - Cable 1000

### Materials

aluminium	14   1M   2M
brass	4   13   16   23
red copper	28

### Ref

5016.1.1M.TX1	white tex
5016.1.2M.TX2	black tex
5016.1.2M.TX3	black tex
5016.1.4.TX4	shiny gold
5016.1.14.TX11	alu satin
5016.1.16.TX4	satin gold
5016.1.13.TXG23	bronze
5016.1.16.TXM	satin gold
5016.1.23.TX23	dark bronze
5016.1.28.TX2	rosé
5016.1.28.TXRK	rosé

**built-up**

with longer lampholder - for CARET lamp  
 mit längerer Hülse - für CARET Leuchtmittel

## 5016.2/.. - MAESTRO - TX

~230V



pendant - with 2m textile cable and strain relief on lampholder's side  
 Pendelleuchte - mit 2m Textilkabel und Zugentlastung an Fassung

### Lamptype

1x A60 E27 max. 10,5W A - E 230V

### Dimensions

Ø45xH110 - Cable 2000

### Materials

aluminium	14   1M   2M
brass	4   13   16   23
red copper	28

### Ref

5016.2.1M.TX1	white tex
5016.2.2M.TX2	black tex
5016.2.2M.TX3	black tex
5016.2.4.TX4	shiny gold
5016.2.14.TX11	alu satin
5016.2.16.TX4	satin gold
5016.2.13.TXG23	bronze
5016.2.16.TXM	satin gold
5016.2.23.TX23	dark bronze
5016.2.28.TX2	rosé
5016.2.28.TXRK	rosé

**built-up**

with longer lampholder - for CARET lamp  
 mit längerer Hülse - für CARET Leuchtmittel

## 5016.3/.. - MAESTRO - TX

~230V



pendant - with 3m textile cable and strain relief on lampholder's side  
 Pendelleuchte - mit 3m Textilkabel und Zugentlastung an Fassung

### Lamptype

1x A60 E27 max. 10,5W A - E 230V

### Dimensions

Ø45xH110 - Cable 3000

### Materials

aluminium	14   1M   2M
brass	4   13   16   23
red copper	28

### Ref

5016.3.1M.TX1	white tex
5016.3.2M.TX2	black tex
5016.3.2M.TX3	black tex
5016.3.4.TX4	shiny gold
5016.3.14.TX11	alu satin
5016.3.16.TX4	satin gold
5016.3.13.TXG23	bronze
5016.3.16.TXM	satin gold
5016.3.23.TX23	dark bronze
5016.3.28.TX2	rosé
5016.3.28.TXRK	rosé

**built-up**

with longer lampholder - for CARET lamp  
 mit längerer Hülse - für CARET Leuchtmittel

## 5016.4/.. - MAESTRO - TX

~230V



pendant - with 4m textile cable and strain relief on lampholder's side  
 Pendelleuchte - mit 4m Textilkabel und Zugentlastung an Fassung

### Lamptype

1x A60 E27 max. 10,5W A - E 230V

### Dimensions

Ø45xH110 - Cable 4000

### Materials

aluminium	14   1M   2M
brass	4   13   16   23
red copper	28

### Ref

5016.4.1M.TX1	white tex
5016.4.2M.TX2	black tex
5016.4.2M.TX3	black tex
5016.4.4.TX4	shiny gold
5016.4.14.TX11	alu satin
5016.4.16.TX4	satin gold
5016.4.13.TXG23	bronze
5016.4.16.TXM	satin gold
5016.4.23.TX23	dark bronze
5016.4.28.TX2	rosé
5016.4.28.TXRK	rosé

**built-up**

with longer lampholder - for CARET lamp  
 mit längerer Hülse - für CARET Leuchtmittel



All M10 spotlights and pendants can be combined with bases (built-in & built-up) and Juba bases as preferred.

Alle M10 Aufbaustrahler und Pendelleuchten können mit Rosetten (In- & Aufbau) und Juba Basen nach Wahl kombiniert werden.

**5003C.1/.. - MAESTRO CARET - TX**

~230V IP20 1 m 0,3000 0,5 m 05.20.02 CE



pendant - with 1m textile cable and strain relief on lampholder's side  
 Pendelleuchte - mit 1m Textilkabel und Zugentlastung an Fassung

**Lamp type**  
 1x A60 E27 max. 10,5W **A** - **E** 230V

**Dimensions**  
 Ø45xH100 - Cable 1000

**Options**  
 P040 - STRAIN RELIEF - TREKONTLASTING

**Materials**  
 aluminium 14 | 1M | 2M  
 brass 4 | 13 | 16 | 23  
 red copper 28

Ref	
5003C.1.1M.TX1	white tex
5003C.1.2M.TX2	black tex
5003C.1.2M.TX3	black tex
5003C.1.4.TX4	shiny gold
5003C.1.14.TX11	alu satin
5003C.1.16.TX4	satin gold
5003C.1.13.TXG23	bronze
5003C.1.23.TX23	dark bronze
5003C.1.28.TX8	rosé
5003C.1.28.TXRK	rosé

*built-up*  
 with longer lampholder - for CARET lamp  
 mit längerer Hülse - für CARET Leuchtmittel

**5003C.2/.. - MAESTRO CARET - TX**

~230V IP20 2 m 0,2300 0,5 m 05.20.02 CE



pendant - with 2m textile cable and strain relief on lampholder's side  
 Pendelleuchte - mit 2m Textilkabel und Zugentlastung an Fassung

**Lamp type**  
 1x A60 E27 max. 10,5W **A** - **E** 230V

**Dimensions**  
 Ø45xH100 - Cable 2000

**Options**  
 P040 - STRAIN RELIEF - TREKONTLASTING

**Materials**  
 aluminium 14 | 1M | 2M  
 brass 4 | 13 | 16 | 23  
 red copper 28

Ref	
5003C.2.1M.TX1	white tex
5003C.2.2M.TX2	black tex
5003C.2.2M.TX3	black tex
5003C.2.4.TX4	shiny gold
5003C.2.14.TX11	alu satin
5003C.2.16.TX4	satin gold
5003C.2.13.TXG23	bronze
5003C.2.23.TX23	dark bronze
5003C.2.28.TX8	rosé
5003C.2.28.TXRK	rosé

*built-up*  
 with longer lampholder - for CARET lamp  
 mit längerer Hülse - für CARET Leuchtmittel

**5003C.3/.. - MAESTRO CARET - TX**

~230V IP20 3 m 0,2500 0,5 m 05.20.02 CE



pendant - with 3m textile cable and strain relief on lampholder's side  
 Pendelleuchte - mit 3m Textilkabel und Zugentlastung an Fassung

**Lamp type**  
 1x A60 E27 max. 10,5W **A** - **E** 230V

**Dimensions**  
 Ø45xH100 - Cable 3000

**Options**  
 P040 - STRAIN RELIEF - TREKONTLASTING

**Materials**  
 aluminium 14 | 1M | 2M  
 brass 4 | 13 | 16 | 23  
 red copper 28

Ref	
5003C.3.1M.TX1	white tex
5003C.3.2M.TX2	black tex
5003C.3.2M.TX3	black tex
5003C.3.4.TX4	shiny gold
5003C.3.14.TX11	alu satin
5003C.3.16.TX4	satin gold
5003C.3.13.TXG23	bronze
5003C.3.23.TX23	dark bronze
5003C.3.28.TX8	rosé
5003C.3.28.TXRK	rosé

*built-up*  
 with longer lampholder - for CARET lamp  
 mit längerer Hülse - für CARET Leuchtmittel

**5003C.4/.. - MAESTRO CARET - TX**

~230V IP20 4 m 0,3000 0,5 m 05.20.02 CE



pendant - with 4m textile cable and strain relief on lampholder's side  
 Pendelleuchte - mit 4m Textilkabel und Zugentlastung an Fassung

**Lamp type**  
 1x A60 E27 max. 10,5W **A** - **E** 230V

**Dimensions**  
 Ø45xH100 - Cable 4000

**Options**  
 P040 - STRAIN RELIEF - TREKONTLASTING

**Materials**  
 aluminium 14 | 1M | 2M  
 brass 4 | 13 | 16 | 23  
 red copper 28

Ref	
5003C.4.1M.TX1	white tex
5003C.4.2M.TX2	black tex
5003C.4.2M.TX3	black tex
5003C.4.4.TX4	shiny gold
5003C.4.14.TX11	alu satin
5003C.4.16.TX4	satin gold
5003C.4.13.TXG23	bronze
5003C.4.23.TX23	dark bronze
5003C.4.28.TX8	rosé
5003C.4.28.TXRK	rosé

*built-up*  
 with longer lampholder - for CARET lamp  
 mit längerer Hülse - für CARET Leuchtmittel

# INDOOR | Ceiling UP | Pendants | MAESTRO

All M10 spotlights and pendants can be combined with bases (built-in & built-up) and Juba bases as preferred.

Alle M10 Aufbaustrahler und Pendelleuchten können mit Rosetten (In- & Aufbau) und Juba Basen nach Wahl kombiniert werden.

PENDANTS

## 5003D.1/.. - MAESTRO CARET - TXW

~230V IP20 1 m 0,2000 0,5 m 05.20.02 CE



pendant - with 1m twisted textile cable and strain relief on lampholder's side  
 Pendelleuchte - mit 1m verdrehtem Textilkabel und Zugentlastung an Fassung

**Lamp type**  
 1x A60 E27 max. 10,5W **A** - **E** 230V

**Dimensions**  
 Ø45xH100 - Cable 1000

**Options**  
 P040 - STRAIN RELIEF - TREKONTLASTING

**Materials**

aluminium	14   1M   2M   46
brass	4   13   16   23
red copper	28

**Ref**

5003D.1.1M.TXW1	white tex
5003D.1.2M.TXW2	black tex
5003D.1.2M.TXW3	black tex
5003D.1.4.TXW4	shiny gold
5003D.1.13.TXG23	bronze
5003D.1.14.TXW11	alu satin
5003D.1.16.TXW4	satin gold
5003D.1.23.TXW23	dark bronze
5003D.1.28.TXW2	rosé
5003D.1.46.TXW23	grey-brown

**built-up**  
 with longer lampholder - for CARET lamp  
 mit längerer Hülse - für CARET Leuchtmittel

## 5003D.2/.. - MAESTRO CARET - TX

~230V IP20 2 m 0,5 m 05.20.02 CE



pendant - with 2m twisted textile cable and strain relief on lampholder's side  
 Pendelleuchte - mit 2m verdrehtem Textilkabel und Zugentlastung an Fassung

**Lamp type**  
 1x A60 E27 max. 10,5W **A** - **E** 230V

**Dimensions**  
 Ø45xH100 - Cable 2000

**Options**  
 P040 - STRAIN RELIEF - TREKONTLASTING

**Materials**

aluminium	14   1M   2M   46
brass	4   13   16   23
red copper	28

**Ref**

5003D.2.1M.TXW1	white tex
5003D.2.2M.TXW2	black tex
5003D.2.2M.TXW3	black tex
5003D.2.4.TXW4	shiny gold
5003D.2.13.TXW23	bronze
5003D.2.14.TXW11	alu satin
5003D.2.16.TXW4	satin gold
5003D.2.23.TXW23	dark bronze
5003D.2.28.TXW2	rosé
5003D.2.28.TXW8	rosé
5003D.2.46.TXW23	grey-brown

**built-up**  
 with longer lampholder - for CARET lamp  
 mit längerer Hülse - für CARET Leuchtmittel

## 5003D.3/.. - MAESTRO CARET - TX

~230V IP20 3 m 0,5 m 05.20.02 CE



pendant - with 3m twisted textile cable and strain relief on lampholder's side  
 Pendelleuchte - mit 3m verdrehtem Textilkabel und Zugentlastung an Fassung

**Lamp type**  
 1x A60 E27 max. 10,5W **A** - **E** 230V

**Dimensions**  
 Ø45xH100 - Cable 3000

**Options**  
 P040 - STRAIN RELIEF - TREKONTLASTING

**Materials**

aluminium	14   1M   2M   46
brass	4   13   16   23
red copper	28

**Ref**

5003D.3.1M.TXW1	white tex
5003D.3.2M.TXW2	black tex
5003D.3.2M.TXW3	black tex
5003D.3.4.TXW4	shiny gold
5003D.3.13.TXW23	bronze
5003D.3.14.TXW11	alu satin
5003D.3.16.TXW4	satin gold
5003D.3.23.TXW23	dark bronze
5003D.3.28.TXW2	rosé
5003D.3.28.TXW8	rosé
5003D.3.46.TXW23	grey-brown

**built-up**  
 with longer lampholder - for CARET lamp  
 mit längerer Hülse - für CARET Leuchtmittel

## 5003D.4/.. - MAESTRO CARET - TX

~230V IP20 4 m 0,5 m 05.20.02 CE



pendant - with 4m twisted textile cable and strain relief on lampholder's side  
 Pendelleuchte - mit 4m verdrehtem Textilkabel und Zugentlastung an Fassung

**Lamp type**  
 1x A60 E27 max. 10,5W **A** - **E** 230V

**Dimensions**  
 Ø45xH100 - Cable 4000

**Options**  
 P040 - STRAIN RELIEF - TREKONTLASTING

**Materials**

aluminium	14   1M   2M   46
brass	4   13   16   23
red copper	28

**Ref**

5003D.4.1M.TXW1	white tex
5003D.4.2M.TXW2	black tex
5003D.4.2M.TXW3	black tex
5003D.4.4.TXW4	shiny gold
5003D.4.13.TXW23	bronze
5003D.4.14.TXW11	alu satin
5003D.4.16.TXW4	satin gold
5003D.4.23.TXW23	dark bronze
5003D.4.28.TXW2	rosé
5003D.4.28.TXW8	rosé
5003D.4.46.TXW23	grey-brown

**built-up**  
 with longer lampholder - for CARET lamp  
 mit längerer Hülse - für CARET Leuchtmittel

All M10 spotlights and pendants can be combined with bases (built-in & built-up) and Juba bases as preferred.

Alle M10 Aufbaustrahler und Pendelleuchten können mit Rosetten (In- & Aufbau) und Juba Basen nach Wahl kombiniert werden.

5003.E27.B3/.. - MAESTRO - B3

~230V



IP20



0,8 m



0,2000



0,5 m



pendant with swivel - rod can be shortened  
Pendelleuchte mit Kugelgelenk - kürzbare Stange

Lamp type

1x A60 E27 max. 10,5W ▶ ▶ 230V

Dimensions

Ø45xH60 - Bar 800

Materials

aluminium	14   1M   2M   46
brass	4   13   16   23
red copper	28

Ref

5003.E27.B3.1M	white tex
5003.E27.B3.2M	black tex
5003.E27.B3.4	shiny gold
5003.E27.B3.13	bronze
5003.E27.B3.14	alu satin
5003.E27.B3.16	satin gold
5003.E27.B3.23	dark bronze
5003.E27.B3.28.2M	rosé
5003.E27.B3.46	grey-brown

built-up

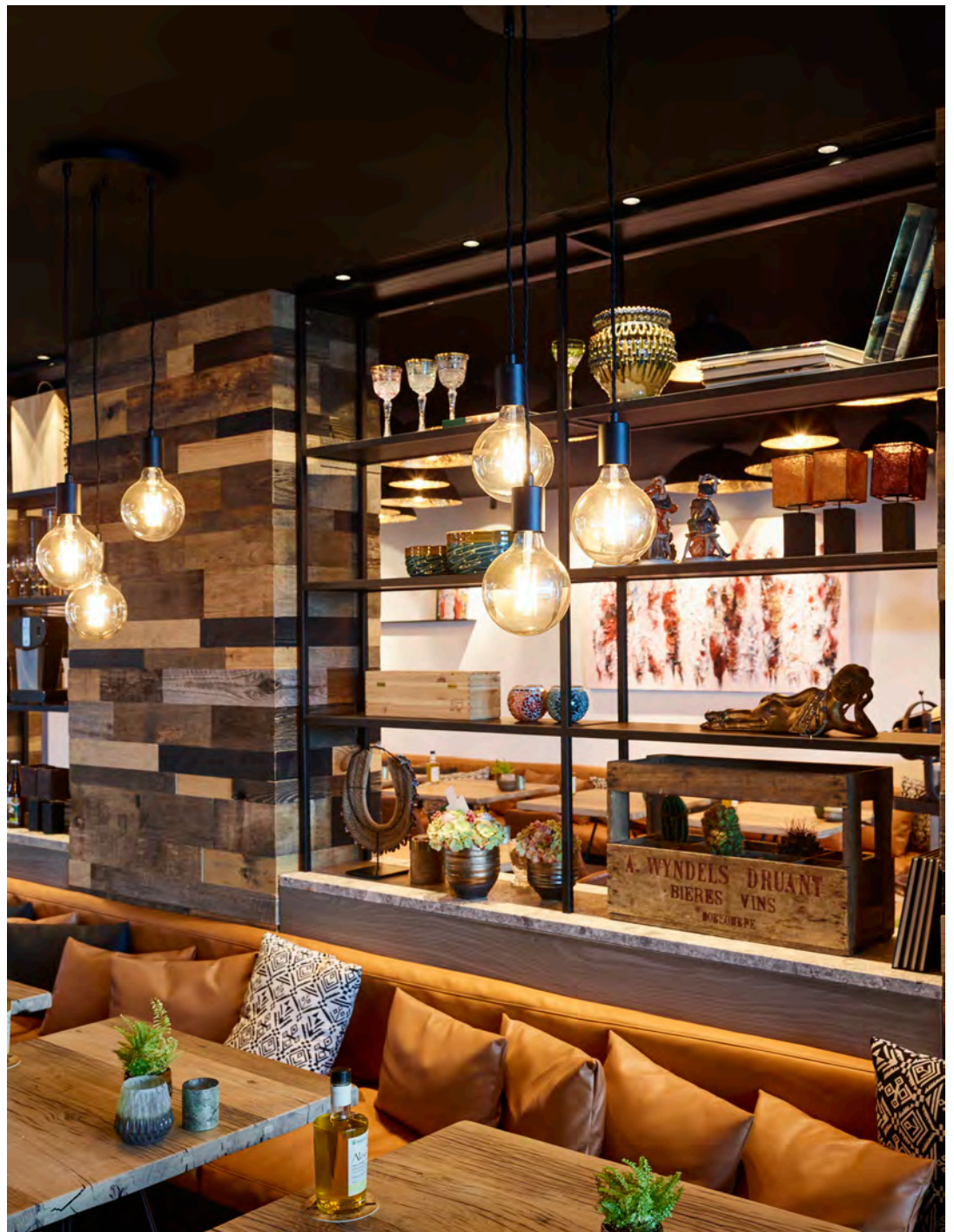



# INDOOR | Ceiling UP | Pendants | MAESTRO

All M10 spotlights and pendants can be combined with bases (built-in & built-up) and Juba bases as preferred.

Alle M10 Aufbaustrahler und Pendelleuchten können mit Rosetten (In- & Aufbau) und Juba Basen nach Wahl kombiniert werden.

PENDANTS

## 5003A.1.E40/.. - MAESTRO E40 - TX

~230V IP20 1 m 0,3500 0,5 m 05.20.02 CE



pendant - E40 LAMPHOLDER - with 1m textile cable and strain relief on lampholder's side  
 Pendelleuchte - E40 FASSUNG - mit 1m Textilkabel und Zugentlastung an Fassung

### Lamp type

1x A200 E40 max. 11W 230V

### Dimensions

Ø45xH60 - Cable 1000

### Options

P040 - STRAIN RELIEF - TREKONTLASTING

### Materials

aluminium 14 | 1M | 2M | 46

### Ref

5003A.1.E40.1M.TX1 white tex  
 5003A.1.E40.2M.TX2 black tex  
 5003A.1.E40.2M.TX9 black tex  
 5003A.1.E40.14.TX11 alu satin  
 5003A.1.E40.46.TXG23 grey-brown

built-up

## 5003A.2.E40/.. - MAESTRO E40 - TX

~230V IP20 2 m 0,6400 0,5 m 05.20.02 CE



pendant - E40 LAMPHOLDER - with 2m textile cable and strain relief on lampholder's side  
 Pendelleuchte - E40 FASSUNG - mit 2m Textilkabel und Zugentlastung an Fassung

### Lamp type

1x A200 E40 max. 11W 230V

### Dimensions

Ø45xH60 - Cable 2000

### Options

P040 - STRAIN RELIEF - TREKONTLASTING

### Materials

aluminium 14 | 1M | 2M | 46

### Ref

5003A.2.E40.1M.TX1 white tex  
 5003A.2.E40.2M.TX2 black tex  
 5003A.2.E40.2M.TX9 black tex  
 5003A.2.E40.14.TX11 alu satin  
 5003A.2.E40.46.TXG23 grey-brown

built-up

## 5003A.3.E40/.. - MAESTRO E40 - TX

~230V IP20 3 m 0,7200 0,5 m 05.20.02 CE



pendant - E40 LAMPHOLDER - with 3m textile cable and strain relief on lampholder's side  
 Pendelleuchte - E40 Fassung - mit 3m Textilkabel und Zugentlastung an Fassung

### Lamp type

1x A200 E40 max. 11W 230V

### Dimensions

Ø45xH60 - Cable 3000

### Options

P040 - STRAIN RELIEF - TREKONTLASTING

### Materials

aluminium 14 | 1M | 2M | 46

### Ref

5003A.3.E40.1M.TX1 white tex  
 5003A.3.E40.2M.TX2 black tex  
 5003A.3.E40.2M.TX9 black tex  
 5003A.3.E40.14.TX11 alu satin  
 5003A.3.E40.46.TXG23 grey-brown

built-up

## 5003A.4.E40/.. - MAESTRO E40 - TX

~230V IP20 4 m 0,7400 0,5 m 05.20.02 CE



pendant - E40 LAMPHOLDER - with 4m textile cable and strain relief on lampholder's side  
 Pendelleuchte - E40 FASSUNG - mit 4m Textilkabel und Zugentlastung an Fassung

### Lamp type

1x A200 E40 max. 11W 230V

### Dimensions

Ø45xH60 - Cable 4000

### Options

P040 - STRAIN RELIEF - TREKONTLASTING

### Materials

aluminium 14 | 1M | 2M | 46

### Ref

5003A.4.E40.1M.TX1 white tex  
 5003A.4.E40.2M.TX2 black tex  
 5003A.4.E40.2M.TX9 black tex  
 5003A.4.E40.14.TX11 alu satin  
 5003A.4.E40.46.TXG23 grey-brown

built-up

5059/.. - MAESTRO

~230V



pendant with twisted textile cable and strain relief - with 3 x cable 1m and 2 x cable 2m  
 Pendelleuchte mit Textilkabel und Zugentlastung - mit 3 x Kabel 1m und 2 x Kabel 2m

Ref

5059.1M.TXW1  
 5059.2M.TXW2

white tex  
 black tex

Lamp type

5x G125 E27 max. 8W A+ - E 230V

Dimensions

Ø350xH30-1280

Ø320xH28

Materials

aluminium 1M | 2M

**built-up**  
 pendants are delivered separately  
 Pendelleuchten werden separat geliefert

5065/.. - MAESTRO

~230V



pendant with twisted textile cable and strain relief - with 10 x cable 1m and 1 x cable 2m  
 Pendelleuchte mit Textilkabel und Zugentlastung - mit 10 x Kabel 1m und 1 x Kabel 2m

Ref

5065.1M.TXW1  
 5065.2M.TXW2

white tex  
 black tex

Lamp type

11x G125 E27 max. 8W A+ - E 230V

Dimensions

Ø500xH28

Ø470

Materials

aluminium 1M | 2M

**built-up**  
 pendants are delivered separately  
 Pendelleuchten werden separat geliefert

5066/.. - MAESTRO

~230V



pendant with twisted textile cable and strain relief - with 9 x cable 1m  
 Pendelleuchte mit Textilkabel und Zugentlastung - mit 9 x Kabel 1m

Ref

5066.1M.TXW1  
 5066.2M.TXW2

white tex  
 black tex

Lamp type

9x G125 E27 max. 8W A+ - E 230V

Dimensions

L400xB400xH30

L370xB370

Materials

aluminium 1M | 2M

**built-up**  
 pendants are delivered separately  
 Pendelleuchten werden separat geliefert



5067.5/.. - MAESTRO

~230V



IP20



1 m



3,9100



0,5 m



05.20.02

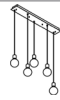

pendant - base 900mm - with 5x cable 1m  
 Pendelleuchte - Basis 900mm - mit 5x Kabel 1M

Lamp type

5x G125 E27 max. 6W A+ - E 230V

Dimensions

L900xB120xH1045 - Cable 1000

L880xB100

Materials

aluminium 2M

Ref

5067.5.2M.TX2 black tex

5067.5.2M.TXW2 black tex

built-up

5067.7/.. - MAESTRO

~230V



IP20



1 m



4,3500



0,5 m



05.20.02

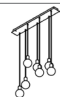

pendant - base 900mm - with 7x cable 1m  
 Pendelleuchte - Basis 900mm - mit 7 x Kabel 1M

Lamp type

7x G125 E27 max. 6W A+ - E 230V

Dimensions

L900xB120xH1045 - Cable 1000

L880xB100

Materials

aluminium 2M

Ref

5067.7.2M.TX2 black tex

5067.7.2M.TXW2 black tex

built-up

5067.9/.. - MAESTRO

~230V



IP20



1 m



6,0000



0,5 m



05.20.02



pendant - base 1200mm - with 9x cable 1 meter  
 Pendelleuchte - Basis 1200mm - mit 9x Kabel 1M

Lamp type

9x G125 E27 max. 6W A+ - E 230V

Dimensions

L1200xB120xH1045 - Cable 1000

L1180xB100

Materials

aluminium 2M

Ref

5067.9.2M.TX2 black tex

5067.9.2M.TXW2 black tex

built-up

5018.5/.. - MAESTRO - B3

~230V IP20 0,8 m 3,1500 0,5 m 05.20.02 CE

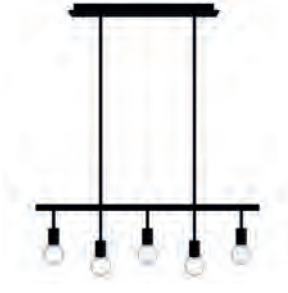

pendant with swivel - rod can be shortened - on bar with 3 x E27 lampholder on rod 7,5cm and 2 x E27 lampholder on rod 15cm  
 Pendelleuchte mit Kugelgelenk - kürzbare Stange - auf Basis mit 3x Fassung E27 auf Stange 7,5cm und 2x Fassung E27 auf Stange 15cm

Ref	
5018.5.1M	white tex
5018.5.2M	black tex

**Lamptype**  
 5x G95 E27 max. 10,5W A+ - E 230V

**Dimensions**  
 L800xB25xH25 - Bar 800  
 L560xB60  
 Base - L600xB100xH35

**Materials**  
 aluminium 1M | 2M

built-up

5019.5/.. - MAESTRO

~230V IP20 1 m 2,9000 0,5 m 05.20.02 CE

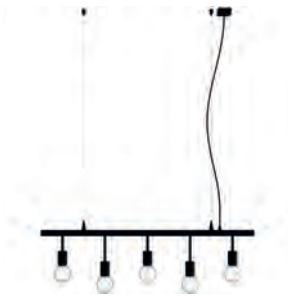

pendant with cable and height controller - on bar with 3 x E27 lampholder on rod 7,5cm and 2 x E27 lampholder on rod 15cm  
 Pendelleuchte mit Kabel und Höheregler - auf Basis mit 3x Fassung E27 auf Stange 7,5cm und 2x Fassung E27 auf Stange 15cm

Ref	
5019.5.1M	white tex
5019.5.2M	black tex

**Lamptype**  
 5x G95 E27 max. 10,5W A+ - E 230V

**Dimensions**  
 L900xB25xH25 - Cable 1000  
 Base - L60xB60xH25

**Materials**  
 aluminium 1M | 2M

built-up

5019.9/.. - MAESTRO

~230V IP20 1 m 0,5 m 05.20.02 CE

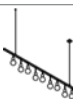
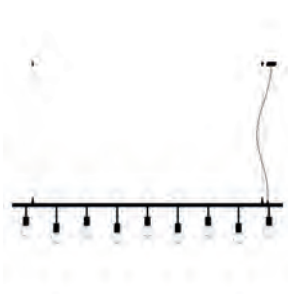

pendant with cable and height controller - on bar with 5 x E27 lampholder on rod 7,5cm and 4 x E27 lampholder on rod 15cm  
 Pendelleuchte mit Kabel und Höheregler - auf Basis mit 5x Fassung E27 auf Stange 7,5cm und 4x Fassung E27 auf Stange 15cm

Ref cat (LONG)	
5019.9.1M	white tex
5019.9.2M	black tex

**Lamptype**  
 5x G95 E27 max. 10,5W A+ - E 230V

**Dimensions**  
 L2000xB25xH25 - Cable 1000  
 Base - L60xB60xH25

**Materials**  
 aluminium 1M | 2M

built-up

5147.7/.. - MAESTRO SPIN - B3

~230V



IP20



2 m



0,5 m



05.20.02



pendant - with 7x textile cable and 6x cable support  
 Pendelleuchte - mit 7x Textilkabel und 6x Kabelhalter

**Lamp type**

7x G95 E27 max. 10,5W **A+** - **E** **230V**

Base - Ø104xH34

**Materials**

aluminium **1M | 2M**

**Ref**

5147.7.1M.TX1	white tex
5147.7.2M.TX2	black tex
5147.7.1M.TXW1	white tex
5147.7.2M.TXW2	black tex

built-up

PENDANTS

5149.9/.. - MAESTRO SPIN - B3

~230V



IP20



2 m



0,5 m



05.20.02



pendant - with 9x textile cable and 8x cable support  
 Pendelleuchte - mit 9x Textilkabel und 8x Kabelhalter

**Lamp type**

9x G95 E27 max. 10,5W **A+** - **E** **230V**

Base - Ø100xH52

**Materials**

aluminium **1M | 2M**

**Ref**

5149.9.1M.TX1	white tex
5149.9.2M.TX2	black tex
5149.9.1M.TXW1	white tex
5149.9.2M.TXW2	black tex

built-up



5001.E27.B3/.. - MAESTRO FOR SHADE - B3

~230V IP20 0,8 m 0,7500 0,5 m 05.20.02 CE



pendant with swivel - rod can be shortened - for shade  
 Pendelleuchte mit Kugelgelenk - kürzbare Stange - für Lampenschirm

Lamp type

1x A60 E27 max. 52W **A** - **E** 230V

Bar - Ø12xH800

Materials

aluminium 14 | 1M | 2M  
 brass 13 | 23

Ref

5001.E27.B3.1M	white tex
5001.E27.B3.2M	black tex
5001.E27.B3.13	bronze
5001.E27.B3.14	alu satin
5001.E27.B3.23	dark bronze

built-up  
 shade not included  
 Lampenschirm nicht einbegriffen

5001.E27.033/.. - MAESTRO FOR SHADE - B3

~230V IP20 0,8 m 0,5 m 05.20.02 CE



pendant with swivel and built-up base - for shade  
 Pendelleuchte mit Kugelgelenk und Aufbaurosette - für Lampenschirm

Lamp type

1x A60 E27 max. 52W **A** - **E** 230V

Dimensions

Ø60xH40 - Bar 800

Materials

aluminium 14 | 1M | 2M  
 brass 4 | 13 | 16 | 23

Ref

5001.E27.033.1M	white tex
5001.E27.033.2M	black tex
5001.E27.033.4	shiny gold
5001.E27.033.13	bronze
5001.E27.033.14	alu satin
5001.E27.033.16	satin gold
5001.E27.033.23	dark bronze

built-up  
 shade not included  
 Lampenschirm nicht einbegriffen

5001.E27.037/.. - MAESTRO FOR SHADE - B3

~230V IP20 0,8 m 0,5500 0,5 m 05.20.02 CE



pendant with swivel and built-up base - for shade  
 Pendelleuchte mit Kugelgelenk und Aufbaurosette - für Lampenschirm

Lamp type

1x A60 E27 max. 52W **A** - **E** 230V

Dimensions

Ø100xH32 - Bar 800

Ø75

Materials

aluminium 14 | 1M | 2M  
 brass 4 | 13 | 16 | 23

Ref

5001.E27.037.1M	white tex
5001.E27.037.2M	black tex
5001.E27.037.4	shiny gold
5001.E27.037.13	bronze
5001.E27.037.14	alu satin
5001.E27.037.16	satin gold
5001.E27.037.23	dark bronze

built-up  
 shade not included  
 Lampenschirm nicht einbegriffen

5007/.. - MAESTRO FOR SHADE

~230V IP20 1,5 m 0,5 m 05.20.02 CE



pendant with cable and height controller - for shade  
 Pendelleuchte mit Kabel und Höheregler - für Lampenschirm

Lamp type

1x A60 E27 max. 60W **A** - **E** 230V

Dimensions

Ø100xH32 - Cable 1500

Ø75

Materials

aluminium 14 | 1M | 2M | 46

Ref

5007.1M.C1	white tex
5007.2M.C2	black tex
5007.14.CT	alu satin
5007.46.C2	grey-brown

built-up  
 shade not included  
 Lampenschirm nicht einbegriffen

5005A/.. - MAESTRO FOR SHADE

~230V IP20 1,5 m 0,5 m 05.20.02 CE



pendant with textile cable and stain relief - with square base  
- for shade  
Pendelleuchte mit Textilkabel und Zugentlastung - mit  
quadratischem Basis - für Lampenschirm

Lamp type

1x A60 E27 max. 42W **A** - **E** 230V

Dimensions

L60xB60xH25 - Cable 1500

Materials

aluminium 14 | 1M | 2M | 46

Ref

5005A.1M.TX1	white tex
5005A.2M.TX2	black tex
5005A.14.TX11	alu satin
5005A.46.TX23	grey-brown

built-up  
for light shade  
für leichten Lampenschirm

5005B/.. - MAESTRO FOR SHADE

~230V IP20 1,5 m 0,2800 0,5 m 05.20.02 CE



pendant with textile cable and stain relief - with round base  
- for shade  
Pendelleuchte mit Textilkabel und Zugentlastung - mit  
rundem Basis - für Lampenschirm

Lamp type

1x A60 E27 max. 42W **A** - **E** 230V

Dimensions

Ø60xH25 - Cable 1500

Materials

aluminium 14 | 1M | 2M | 46

Ref

5005B.1M.TX1	white tex
5005B.2M.TX2	black tex
5005B.14.TX11	alu satin
5005B.46.TX23	grey-brown

built-up  
for light shade  
für leichten Lampenschirm





5002.E27.B3/.. - MAESTRO FOR SHADE - B3

~230V



IP20



0,8 m



0,5 m



pendant with swivel and built-up base - for shade  
 Pendelleuchte mit Kugelgelenk und Aufbaurosette - für  
 Lampenschirm

Lamp type

2x A60 E27 max. 60W A - E 230V

Dimensions

Bar 800

Ø75

Base - Ø100xH32

Materials

aluminium 14 | 1M | 2M | 46

Ref

5002.E27.B3.1M	white tex
5002.E27.B3.2M	black tex
5002.E27.B3.14	alu satin
5002.E27.B3.46	grey-brown

built-up  
 shade not included  
 Lampenschirm nicht einbegriffen

5004.E27.B3/.. - MAESTRO FOR SHADE - B3

~230V



IP20



0,8 m



0,5 m



pendant with swivel and built-up base - for shade  
 Pendelleuchte mit Kugelgelenk und Aufbaurosette - für  
 Lampenschirm

Lamp type

4x A60 E27 max. 60W A - E 230V

Dimensions

Bar 800

Ø75

Base - Ø100xH32

Materials

aluminium 2 | 14 | 1M | 2M | 46

Ref

5004.E27.B3.1M	white tex
5004.E27.B3.2	black
5004.E27.B3.2M	black tex
5004.E27.B3.14	alu satin
5004.E27.B3.46	grey-brown

built-up  
 shade not included  
 Lampenschirm nicht einbegriffen



5012../.. - MAESTRO FOR SHADE - B3

~230V



IP20



0,8 m



0,5 m



pendant with swivel - rod can be shortened - for shade  
 Pendelleuchte mit Kugelgelenk - kürzbare Stange - für  
 Lampenschirm

Lamp type

2x A60 E27 max. 60W A - E **230V**

Dimensions

L600xB100xH35 - Bar 800

L560xB60

Materials

aluminium 14 | 1M | 2M | 46  
 brass 23

Ref

5012.1M	white tex
5012.2M	black tex
5012.14	alu satin
5012.23	dark bronze
5012.46	grey-brown

built-up  
 shades not included  
 Lampenschirme nicht einbegriffen

5013../.. - MAESTRO FOR SHADE - B3

~230V



IP20



0,8 m



0,5 m



pendant with swivel - rod can be shortened - for shade  
 Pendelleuchte mit Kugelgelenk - kürzbare Stange - für  
 Lampenschirm

Lamp type

3x A60 E27 max. 60W A - E **230V**

Dimensions

L900xB80xH30 - Bar 800

L860xB60

Materials

aluminium 14 | 1M | 2M | 46  
 brass 23

Ref

5013.1M	white tex
5013.2M	black tex
5013.14	alu satin
5013.23	dark bronze
5013.46	grey-brown

built-up  
 shades not included  
 Lampenschirme nicht einbegriffen

5015.2../.. - MAESTRO FOR SHADE - B3

~230V



IP20



0,8 m



0,5 m

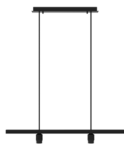

pendant with swivel - rod can be shortened  
 Pendelleuchte mit Kugelgelenk - kürzbare Stange

Lamp type

2x A60 E27 max. 60W A - E **230V**

Dimensions

L800xB25xH25 - Bar 800

L560xB60

Base - L600xB100xH35

Materials

aluminium 14 | 1M | 2M | 46

Ref

5015.2.1M	white tex
5015.2.2M	black tex
5015.2.14	alu satin
5015.2.46	grey-brown

built-up  
 shades not included  
 Lampenschirme nicht einbegriffen

5015.3../.. - MAESTRO FOR SHADE

~230V



IP20



0,8 m



0,5 m



pendant with swivel - rod can be shortened  
 Pendelleuchte mit Kugelgelenk - kürzbare Stange

Lamp type

3x A60 E27 max. 60W A - E **230V**

Dimensions

L1000xB25xH25 - Bar 800

L560xB60

Base - L600xB100xH35

Materials

aluminium 14 | 1M | 2M | 46

Ref

5015.3.1M	white tex
5015.3.2M	black tex
5015.3.14	alu satin
5015.3.46	grey-brown

built-up  
 shades not included  
 Lampenschirme nicht einbegriffen

5015.4/.. - MAESTRO FOR SHADE

~230V IP20 0,8 m 0,5 m 05.20.02 CE

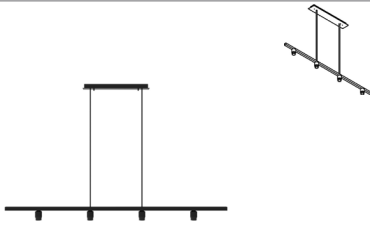

pendant with swivel - rod can be shortened  
 Pendelleuchte mit Kugelgelenk - kürzbare Stange

**Lamp type**  
 4x A60 E27 max. 60W **A** - **E** 230V

**Dimensions**  
 L1500xB25xH25 - Bar 800  
 L560xB60  
 Base - L600xB100xH35

**Materials**  
 aluminium 14 | 1M | 2M | 46

Ref	
5015.4.1M	white tex
5015.4.2M	black tex
5015.4.14	alu satin
5015.4.46	grey-brown

built-up  
 shades not included  
 Lampenschirme nicht einbegriffen

5015.5/.. - MAESTRO FOR SHADE

~230V IP20 0,8 m 3,350 0,5 m 05.20.02 CE

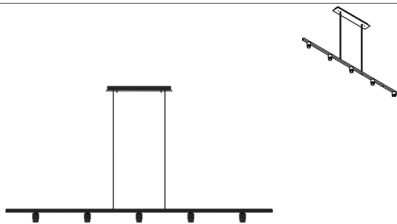

pendant with swivel - rod can be shortened  
 Pendelleuchte mit Kugelgelenk - kürzbare Stange

**Lamp type**  
 5x A60 E27 max. 60W **A** - **E** 230V

**Dimensions**  
 L1800xB25xH25 - Bar 800  
 L560xB60  
 Base - L600xB100xH35

**Materials**  
 aluminium 14 | 1M | 2M | 46

Ref cat (LONG)	
5015.5.1M	white tex
5015.5.2M	black tex
5015.5.14	alu satin
5015.5.46	grey-brown

built-up  
 shades not included  
 Lampenschirme nicht einbegriffen

5017.3/.. - MAESTRO FOR SHADE

~230V IP20 1,5 m 0,5 m 05.20.02 CE



pendant - with cable suspension  
 Pendelleuchte - mit Kabelaufhängung

**Lamp type**  
 3x A60 E27 max. 60W **A** - **E** 230V

**Dimensions**  
 L1000xB25xH25  
 Base - L600xB60xH25

**Materials**  
 aluminium 14 | 1M | 2M | 46

Ref	
5017.3.1M	white tex
5017.3.2M	black tex
5017.3.14	alu satin
5017.3.46	grey-brown

built-up  
 shades not included  
 Lampenschirme nicht einbegriffen



PENDANTS



5081.16/.. - GALAXY

~230V  IP20    0,5 m  

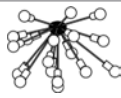

built-up ceiling light - fixed  
Aufbau Deckenleuchte - fest

**Lamp type**  
16x G95 E27 max. 6,5W  230V

**Dimensions**  
Ø1200xH520  
Base - Ø123xH60  
Bar - L150  
Bar - L200  
Bar - L300  
Bar - L400  
Bar - L600

**Materials**  
aluminium 1M | 2M | 45

**Ref**  
5081.16.1M white tex  
5081.16.2M black tex  
5081.16.45 sun gold

built-up

5080.19/.. - GALAXY - B3

~230V  IP 20    0,8 m  



pendant - fixed  
Pendelleuchte - fest

**Lamp type**  
19x G80 E27 max. 40W  230V

**Dimensions**  
Ø1000xH1200 - Bar 600  
Base - Ø125xH37  
Bar - L150  
Bar - L200  
Bar - L300  
Bar - L400  
Bar - L600

**Materials**  
aluminium 1M | 2M | 45

**Ref**  
5080.19.1M white tex  
5080.19.2M black tex  
5080.19.45 sun gold

built-up

5080.31/.. - GALAXY

~230V  IP 20    0,8 m  



pendant - fixed  
Pendelleuchte - fest

**Lamp type**  
31x G80 E27 max. 40W  230V

**Dimensions**  
Ø1300xH1200 - Bar 600  
Bar - L600  
Base - Ø125xH37  
Bar - L150  
Bar - L200  
Bar - L300  
Bar - L400

**Materials**  
aluminium 1M | 2M | 45

**Ref**  
5080.31.1M white tex  
5080.31.2M black tex  
5080.31.45 sun gold

built-up

5085.40/.. - GALAXY WHEEL

~230V  IP 20    2 m  



pendant - fixed  
Pendelleuchte - fest

**Lamp type**  
40x G80 E27 max. 40W  230V  
or 40x G120 E27 max. 40W  230V

**Dimensions**  
Ø620xH2000 - Cable 2000  
Base - Ø50xH40

**Materials**  
aluminium 1M | 2M | 45

**Ref cat (LONG)**  
5085.40.1M white tex  
5085.40.2M black tex  
5085.40.45 sun gold

built-up



4980.E27/.. - ANGELO

~230V IP20 1,5 m 0,2300 0,5 m 05.20.02 CE



built-up

pendant - round - with 1,5m textile cable and strain relief on lampholder's side  
 Pendelleuchte - rund - mit 1,5m Textilkabel und Zugentlastung an Fassung

**Lamp type**  
 1x A60 E27 max. 10,5W **A** - **E** 230V  
 or 1x G80 E27 max. 40W **A** - **E** 230V

**Dimensions**  
 Ø150xH70 - Cable 1500

**Materials**  
 aluminium 1M | 2M | 45 | 74 | 80 | 84  
 brass 16

**Ref**

4980.E27.1M.TX1	white tex
4980.E27.2M.TX2	black tex
4980.E27.16.TXM	satın gold
4980.E27.45.TXM	sun gold
4980.E27.74.TXG13	noble bronze
4980.E27.84.TXRK2	copper metallic
4980.E27.80.TXRK	pastel copper

4981.E27/.. - ANGELO

~230V IP20 1,5 m 0,2300 0,5 m 05.20.02 CE

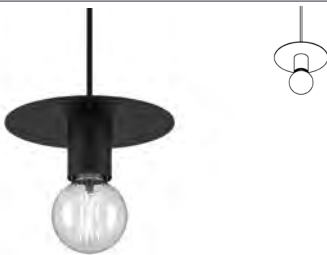

built-up

pendant - round - with 1,5m textile cable and strain relief on lampholder's side  
 Pendelleuchte - rund - mit 1,5m Textilkabel und Zugentlastung an Fassung

**Lamp type**  
 1x A60 E27 max. 10,5W **A** - **E** 230V  
 or 1x G80 E27 max. 40W **A** - **E** 230V

**Dimensions**  
 Ø180xH70 - Cable 1500

**Materials**  
 aluminium 1M | 2M | 45 | 74 | 80 | 84  
 brass 16

**Ref**

4981.E27.1M.TX1	white tex
4981.E27.2M.TX2	black tex
4981.E27.16.TXM	satın gold
4981.E27.45.TXM	sun gold
4981.E27.74.TXG13	noble bronze
4981.E27.84.TXRK2	copper metallic
4981.E27.80.TXRK	pastel copper

4982.E27/.. - ANGELO

~230V IP20 1,5 m 0,2300 0,5 m 05.20.02 CE



built-up

pendant - round - with 1,5m textile cable and strain relief on lampholder's side  
 Pendelleuchte - rund - mit 1,5m Textilkabel und Zugentlastung an Fassung

**Lamp type**  
 1x A60 E27 max. 10,5W **A** - **E** 230V  
 or 1x G80 E27 max. 40W **A** - **E** 230V

**Dimensions**  
 Ø250xH70 - Cable 1500

**Materials**  
 aluminium 1M | 2M | 45 | 74 | 80 | 84  
 brass 16

**Ref**

4982.E27.1M.TX1	white tex
4982.E27.2M.TX2	black tex
4982.E27.16.TXM	satın gold
4982.E27.45.TXM	sun gold
4982.E27.74.TXG13	noble bronze
4982.E27.84.TXRK2	copper metallic
4982.E27.80.TXRK	pastel copper

4983.E27/.. - ANGELO

~230V IP20 1,5 m 0,2300 0,5 m 05.20.02 CE



built-up

pendant - round - with 1,5m textile cable and strain relief on lampholder's side  
 Pendelleuchte - rund - mit 1,5m Textilkabel und Zugentlastung an Fassung

**Lamp type**  
 1x A60 E27 max. 10,5W **A** - **E** 230V  
 or 1x G80 E27 max. 40W **A** - **E** 230V

**Dimensions**  
 Ø300xH70 - Cable 1500

**Materials**  
 aluminium 1M | 2M | 45 | 74 | 80 | 84  
 brass 16

**Ref**

4983.E27.1M.TX1	white tex
4983.E27.2M.TX2	black tex
4983.E27.16.TXM	satın gold
4983.E27.45.TXM	sun gold
4983.E27.74.TXG13	noble bronze
4983.E27.84.TXRK2	copper metallic
4983.E27.80.TXRK	pastel copper



4984.SH.E27/.. - ANGELO

~230V IP20 1,5 m 0,5 m 05.20.02 CE



pendant - round - with 1,5m textile cable and strain relief on lampholder's side  
 Pendelleuchte - rund - mit 1,5m Textilkabel und Zugentlastung an Fassung

Lamp type

- 1x A60 E27 max. 10,5W A - E 230V
- 1x G80 E27 max. 40W A - E 230V

Dimensions

Ø150xH70 - Cable 1500

Materials

aluminium 1M | 2M | 45 | 74 | 80 | 84  
 brass 16

Ref

- 4984.SH.E27.1M.TX1 white tex
- 4984.SH.E27.2M.TX2 black tex
- 4984.SH.E27.16.TXM satin gold
- 4984.SH.E27.45.TXM sun gold
- 4984.SH.E27.74.TXG13 noble bronze
- 4984.SH.E27.84.TXRK2 copper metallic
- 4984.SH.E27.80.TXRK pastel copper

built-up

4985.SH.E27/.. - ANGELO

~230V IP20 1,5 m 0,5 m 05.20.02 CE



pendant - round - with 1,5m textile cable and strain relief on lampholder's side  
 Pendelleuchte - rund - mit 1,5m Textilkabel und Zugentlastung an Fassung

Lamp type

- 1x A60 E27 max. 10,5W A - E 230V
- 1x G80 E27 max. 40W A - E 230V

Dimensions

Ø180xH70 - Cable 1500

Materials

aluminium 1M | 2M | 45 | 74 | 80 | 84  
 brass 16

Ref

- 4985.SH.E27.1M.TX1 white tex
- 4985.SH.E27.2M.TX2 black tex
- 4985.SH.E27.16.TXM satin gold
- 4985.SH.E27.45.TXM sun gold
- 4985.SH.E27.74.TXG13 noble bronze
- 4985.SH.E27.84.TXRK2 copper metallic
- 4985.SH.E27.80.TXRK pastel copper

built-up

4986.SH.E27/.. - ANGELO

~230V IP20 1,5 m 0,5 m 05.20.02 CE



pendant - round - with 1,5m textile cable and strain relief on lampholder's side  
 Pendelleuchte - rund - mit 1,5m Textilkabel und Zugentlastung an Fassung

Lamp type

- 1x A60 E27 max. 10,5W A - E 230V
- 1x G80 E27 max. 40W A - E 230V

Dimensions

Ø250xH70 - Cable 1500

Materials

aluminium 1M | 2M | 45 | 74 | 80 | 84  
 brass 16

Ref

- 4986.SH.E27.1M.TX1 white tex
- 4986.SH.E27.2M.TX2 black tex
- 4986.SH.E27.16.TXM satin gold
- 4986.SH.E27.45.TXM sun gold
- 4986.SH.E27.74.TXG13 noble bronze
- 4986.SH.E27.84.TXRK2 copper metallic
- 4986.SH.E27.80.TXRK pastel copper

built-up

4987.SH.E27/.. - ANGELO

~230V IP20 1,5 m 0,5 m 05.20.02 CE



pendant - round - with 1,5m textile cable and strain relief on lampholder's side  
 Pendelleuchte - rund - mit 1,5m Textilkabel und Zugentlastung an Fassung

Lamp type

- 1x A60 E27 max. 10,5W A - E 230V
- 1x G80 E27 max. 40W A - E 230V

Dimensions

Ø300xH70 - Cable 1500

Materials

aluminium 1M | 2M | 45 | 74 | 80 | 84  
 brass 16

Ref

- 4987.SH.E27.1M.TX1 white tex
- 4987.SH.E27.2M.TX2 black tex
- 4987.SH.E27.16.TXM satin gold
- 4987.SH.E27.45.TXM sun gold
- 4987.SH.E27.74.TXG13 noble bronze
- 4987.SH.E27.84.TXRK2 copper metallic
- 4987.SH.E27.80.TXRK pastel copper

built-up

4990.E27/.. - SKIVVE

~230V IP20 1,5 m 0,2300 0,5 m 05.20.02 CE



pendant - round - with 1,5m textile cable and strain relief on lampholder's side  
 Pendelleuchte - rund - mit 1,5m Textilkabel und Zugentlastung an Fassung

Lamp type

1x A60 E27 max. 10,5W A - E 230V

Dimensions

Ø180xH135 - Cable 1500

Materials

aluminium 1M | 29 | 2M | 47 | 49

Ref

4990.E27.1M.TX1	white tex
4990.E27.2M.TX2	black tex
4990.E27.29.TX2	black - gold in
4990.E27.47.TX2	black - white in
4990.E27.49.TX2	white - gold in

built-up

4991.E27/.. - SKIVVE

~230V IP20 1,5 m 0,2300 0,5 m 05.20.02 CE



pendant - round - with 1,5m textile cable and strain relief on lampholder's side  
 Pendelleuchte - rund - mit 1,5m Textilkabel und Zugentlastung an Fassung

Lamp type

1x A60 E27 max. 10,5W A - E 230V

or 1x G80 E27 max. 40W A - E 230V

Dimensions

Ø250xH135 - Cable 1500

Materials

aluminium 1M | 29 | 2M | 47 | 49

Ref

4991.E27.1M.TX1	white tex
4991.E27.2M.TX2	black tex
4991.E27.29.TX2	black - gold in
4991.E27.47.TX2	black - white in
4991.E27.49.TX2	white - gold in

built-up

4992.E27/.. - SKIVVE

~230V IP20 1,5 m 0,2300 0,5 m 05.20.02 CE



with 1,5m textile cable and strain relief on lampholder's side  
 mit 1,5m Textilkabel und Zugentlastung an Fassung

Lamp type

1x A60 E27 max. 10,5W A - E 230V

or 1x G80 E27 max. 40W A - E 230V

Dimensions

Ø350xH135 - Cable 1500

Materials

aluminium 1M | 29 | 2M | 47 | 49

Ref

4992.E27.1M.TX1	white tex
4992.E27.2M.TX2	black tex
4992.E27.29.TX2	black - gold in
4992.E27.47.TX2	black - white in
4992.E27.49.TX2	white - gold in

built-up



1409/.. - C-LINE - TX

~230V IP20 1,5 m 0,5 m 05.20.02 CE



pendant - with 1,5m textile cable and strain relief on lampholder's side  
 Pendelleuchte - mit 1,5m Textilkabel und Zugentlastung an Fassung

**Lamp type**  
 1x A60 E27 max. 10,5W **A** - **E** 230V

**Dimensions**  
 Ø270 - Cable 1500

**Materials**  
 aluminium 1M | 2M

Ref	
1409.1M.1M.TX1	white tex
1409.1M.1M.TXW1	white tex
1409.2M.2M.TX2	black tex
1409.2M.2M.TXW2	black tex
1409.2M.16.TXW2	black tex
1409.2M.16.TXM	black tex
1409.2M.16.TX2	black tex
1409.2M.28.TX2	black tex
1409.2M.28.TX2	black tex
1409.2M.28.TX2	black tex

built-up

1410/.. - C-LINE - TX

~230V IP20 1,5 m 0,8100 0,5 m 05.20.02 CE



pendant - with 1,5m textile cable and strain relief on lampholder's side  
 Pendelleuchte - mit 1,5m Textilkabel und Zugentlastung an Fassung

**Lamp type**  
 1x A60 E27 max. 10,5W **A** - **E** 230V

**Dimensions**  
 Ø320 - Cable 1500

**Materials**  
 aluminium 1M | 2M

Ref	
1410.1M.1M.TX1	white tex
1410.1M.1M.TXW1	white tex
1410.2M.2M.TX2	black tex
1410.2M.2M.TXW2	black tex
1410.2M.16.TXW2	black tex
1410.2M.16.TXM	black tex
1410.2M.16.TX2	black tex
1410.2M.28.TX2	black tex
1410.2M.28.TXW2	black tex
1410.2M.28.TX2	black tex

built-up

1417/.. - C-LINE - TX

~230V IP20 1,5 m 0,8600 0,5 m 05.20.02 CE



pendant - with 1,5m textile cable and strain relief on lampholder's side  
 Pendelleuchte - mit 1,5m Textilkabel und Zugentlastung an Fassung

**Lamp type**  
 1x A60 E27 max. 10,5W **A** - **E** 230V

**Dimensions**  
 Ø270 - Cable 1500

**Materials**  
 aluminium 1M | 2M

Ref	
1417.1M.1M.TX1	white tex
1417.1M.1M.TXW1	white tex
1417.2M.2M.TX2	black tex
1417.2M.2M.TXW2	black tex
1417.2M.16.TXW2	black tex
1417.2M.16.TXM	black tex
1417.2M.16.TX2	black tex
1417.2M.28.TX2	black tex
1417.2M.28.TXW2	black tex
1417.2M.28.TX2	black tex

built-up

1418/.. - C-LINE - TX

~230V IP20 1,5 m 1,0200 0,5 m 05.20.02 CE



pendant - with 1,5m textile cable and strain relief on lampholder's side  
 Pendelleuchte - mit 1,5m Textilkabel und Zugentlastung an Fassung

**Lamp type**  
 1x A60 E27 max. 10,5W **A** - **E** 230V

**Dimensions**  
 Ø320 - Cable 1500

**Materials**  
 aluminium 1M | 2M

Ref	
1418.1M.1M.TX1	white tex
1418.1M.1M.TXW1	white tex
1418.2M.2M.TX2	black tex
1418.2M.2M.TXW2	black tex
1418.2M.16.TXW2	black tex
1418.2M.16.TXM	black tex
1418.2M.16.TX2	black tex
1418.2M.28.TX2	black tex
1418.2M.28.TXW2	black tex
1418.2M.28.TX2	black tex

built-up





 **DOVY**

*Made in  
Belgium*

Brevet GRATUIT de Dovy-Fabrics  
Visitez GRATUITEMENT l'usine de...





1363/.. - FARFALLE - TX

~230V



IP20



1,5 m



0,5 m



05.20.02



pendant - with 1,5m textile cable and strain relief on lampholder's side  
 Pendelleuchte - mit 1,5m Textilkabel und Zugentlastung an Fassung

**Lamptype**

1x A60 E27 max. 10,5W A - E 230V

**Dimensions**

Ø320xH70 - Cable 1500

**Materials**

aluminium 1M | 2M | 45 | 78 | 79 | 81 | 93

**Ref**

1363.1M.TX1	white tex
1363.2M.TX2	black tex
1363.2M.16.TX2	black tex
1363.45.TX4	sun gold
1363.93.TXJ	bronze-brown
1363.78.TX192	pastel blue
1363.79.TX30	pastel pink
1363.81.TX364	pastel green

built-up

1364/.. - FARFALLE

~230V



IP20



1,5 m



0,5 m



05.20.02

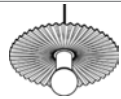

pendant - with 1,5m textile cable and strain relief on lampholder's side  
 Pendelleuchte - mit 1,5m Textilkabel und Zugentlastung an Fassung

**Lamptype**

1x A60 E27 max. 10,5W A - E 230V

**Dimensions**

Ø390xH70 - Cable 1500

**Materials**

aluminium 1M | 2M | 45 | 78 | 79 | 81 | 93







**Ref**



1364.1M.TX1	white tex
1364.2M.TX2	black tex
1364.2M.16.TX2	black tex
1364.45.TX4	sun gold
1364.93.TXJ	bronze-brown
1364.78.TX192	pastel blue
1364.79.TX30	pastel pink
1364.81.TX364	pastel green



All M10 spotlights and pendants can be combined with bases (built-in & built-up) and Juba bases as preferred.

Alle M10 Aufbaustrahler und Pendelleuchten können mit Rosetten (In- & Aufbau) und Juba Basen nach Wahl kombiniert werden.

**1821.E27.250/.. - MERO PENDEL - TX** ~230V  IP20   1,5 m  0,5 m  

pendant - round - with 1,5m textile cable and strain relief on lampholder's side  
 Pendelleuchte - rund - mit 1,5m Textilkabel und Zugentlastung an Fassung

**Lamp type**

 1x G125 E27 max. 4W A+ - E 240V

or  1x G95 E27 max. 10,5W A+ - E 230V

**Dimensions**

 Ø60xH250 - Cable 1500

**Options**

055B - ROSETTE for textile cable







**Materials**



aluminium 1M | 2M | 45

**Ref**

1821.E27.250.1M.TX1 white tex  
 1821.E27.250.2M.TX2 black tex  
 1821.E27.250.45.TX4 sun gold

*built-up*

**1821.E27.300/.. - MERO PENDEL - TX** ~230V  IP20   1,5 m  0,5 m  

pendant - round - with 1,5m textile cable and strain relief on lampholder's side  
 Pendelleuchte - rund - mit 1,5m Textilkabel und Zugentlastung an Fassung

**Lamp type**

 1x G125 E27 max. 6W A+ - E 230V

or  1x G95 E27 max. 6W A+ - E 230V

**Dimensions**

 Ø60xH300 - Cable 1500

**Options**

055B - ROSETTE for textile cable







**Materials**



aluminium 1M | 2M | 45

**Ref**

1821.E27.300.1M.TX1 white tex  
 1821.E27.300.2M.TX2 black tex  
 1821.E27.300.45.TX4 sun gold

*built-up*

**1821.E27.450/.. - MERO PENDEL - TX** ~230V  IP20   1,5 m  0,5 m  

pendant - round - with 1,5m textile cable and strain relief on lampholder's side  
 Pendelleuchte - rund - mit 1,5m Textilkabel und Zugentlastung an Fassung

**Lamp type**

 1x G125 E27 max. 4W A+ - E 240V

or  1x G95 E27 max. 10,5W A+ - E 230V

**Dimensions**

 Ø60xH450 - Cable 1500

**Options**

055B - ROSETTE for textile cable







**Materials**



aluminium 1M | 2M | 45

**Ref**

1821.E27.450.1M.TX1 white tex  
 1821.E27.450.2M.TX2 black tex  
 1821.E27.450.45.TX4 sun gold

*built-up*

**1821.E27.500/.. - MERO PENDEL - TX** ~230V  IP20   1,5 m  0,5 m  

pendant - round - with 1,5m textile cable and strain relief on lampholder's side  
 Pendelleuchte - rund - mit 1,5m Textilkabel und Zugentlastung an Fassung

**Lamp type**

 1x G125 E27 max. 4W A+ - E 240V

or  1x G95 E27 max. 10,5W A+ - E 230V

**Dimensions**

 Ø60xH500 - Cable 1500

**Options**

055B - ROSETTE for textile cable

**Materials**

aluminium 1M | 2M | 45

**Ref**

1821.E27.500.1M.TX1 white tex  
 1821.E27.500.2M.TX2 black tex  
 1821.E27.500.45.TX4 sun gold

*built-up*

PENDANTS

## INDOOR | Ceiling UP | Pendants | MERO

All M10 spotlights and pendants can be combined with bases (built-in & built-up) and Juba bases as preferred.

Alle M10 Aufbaustrahler und Pendelleuchten können mit Rosetten (In- & Aufbau) und Juba Basen nach Wahl kombiniert werden.

### 1838.ES50.250/.. - MERO PENDEL - TX

~230V  IP20    1,5 m  0,5700  0,5 m  05.20.02 



built-up

pendant - round - with 1,5m textile cable and strain relief on lampholder's side  
Pendelleuchte - rund - mit 1,5m Textilkabel und Zugentlastung an Fassung

**Ref**  
1838.ES50.250.1M.TX1 white tex  
1838.ES50.250.2M.TX2 black tex  
1838.ES50.250.45.TX4 sun gold

**Lamp type**  
 1x QPAR 51 GU10 max. 20W  -  230V

**Dimensions**  
 Ø60xH250 - Cable 1500

**Options**  
055B - ROSETTE for textile cable

**Materials**  
aluminium 1M | 2M | 45

### 1838.ES50.300/.. - MERO PENDEL - TX

~230V  IP20    1,5 m  0,6400  0,5 m  05.20.02 



built-up

pendant - round - with 1,5m textile cable and strain relief on lampholder's side  
Pendelleuchte - rund - mit 1,5m Textilkabel und Zugentlastung an Fassung

**Ref**  
1838.ES50.300.1M.TX1 white tex  
1838.ES50.300.2M.TX2 black tex  
1838.ES50.300.45.TX4 sun gold

**Lamp type**  
 1x QPAR 51 GU10 max. 20W  -  230V

**Dimensions**  
 Ø60xH300 - Cable 1500

**Options**  
055B - ROSETTE for textile cable

**Materials**  
aluminium 1M | 2M | 45

### 1838.ES50.450/.. - MERO PENDEL - TX

~230V  IP20    1,5 m  0,9000  0,5 m  05.20.02 



built-up

pendant - round - with 1,5m textile cable and strain relief on lampholder's side  
Pendelleuchte - rund - mit 1,5m Textilkabel und Zugentlastung an Fassung

**Ref**  
1838.ES50.450.1M.TX1 white tex  
1838.ES50.450.2M.TX2 black tex  
1838.ES50.450.45.TX4 sun gold

**Lamp type**  
 1x QPAR 51 GU10 max. 20W  -  230V

**Dimensions**  
 Ø60xH450 - Cable 1500

**Options**  
055B - ROSETTE for textile cable

**Materials**  
aluminium 1M | 2M | 45

### 1838.ES50.675/.. - MERO PENDEL - TX

~230V  IP20    1,5 m  1,1100  0,5 m  05.20.02 



built-up

pendant - round - with 1,5m textile cable and strain relief on lampholder's side  
Pendelleuchte - rund - mit 1,5m Textilkabel und Zugentlastung an Fassung

**Ref**  
1838.ES50.675.1M.TX1 white tex  
1838.ES50.675.2M.TX2 black tex  
1838.ES50.675.45.TX4 sun gold

**Lamp type**  
 1x QPAR 51 GU10 max. 20W  -  230V

**Dimensions**  
 Ø60xH675 - Cable 1500

**Options**  
055B - ROSETTE for textile cable

**Materials**  
aluminium 1M | 2M | 45

All M10 spotlights and pendants can be combined with bases (built-in & built-up) and Juba bases as preferred.

Alle M10 Aufbaustrahler und Pendelleuchten können mit Rosetten (In- & Aufbau) und Juba Basen nach Wahl kombiniert werden.

**1838.ES50.900/.. - MERO PENDEL - TX**

~230V



IP20



1,5 m



1,5300



0,5 m



05.20.02



pendant - round - with 1,5m textile cable and strain relief on lampholder's side  
 Pendelleuchte - rund - mit 1,5m Textilkabel und Zugentlastung an Fassung

**Ref**

- 1838.ES50.900.1M.TX1 white tex
- 1838.ES50.900.2M.TX2 black tex
- 1838.ES50.900.45.TX4 sun gold

**Lamp type**

1x QPAR 51 GU10 max. 20W A+ - E 230V

**Dimensions**

Ø60xH900 - Cable 1500

**Options**

055B - ROSETTE for textile cable

**Materials**

aluminium

1M | 2M | 45

*built-up*





# INDOOR | Ceiling UP | Pendants | MERO

All M10 spotlights and pendants can be combined with bases (built-in & built-up) and Juba bases as preferred.

Alle M10 Aufbaustrahler und Pendelleuchten können mit Rosetten (In- & Aufbau) und Juba Basen nach Wahl kombiniert werden.

## 1842.AC.250/.. - MERO PENDEL - TX

~230V  IP20   1,5 m  0,6800  0,5 m  



pendant - round - with 1,5m textile cable and strain relief on lampholder's side  
 Pendelleuchte - rund - mit 1,5m Textilkabel und Zugentlastung an Fassung

Ref	CW	NW	WW
1842C.250.1M.TX1			
1842C.250.2M.TX2			
1842C.250.45.TX4			

**Lamp type**  
 1x LED AC 700lm CRI92 max. 9,5W  230V

**Dimensions**  
 Ø60xH250  36 - Cable 1500

**Options**  
 055B - ROSETTE for textile cable

built-up



## 1842.AC.300/.. - MERO PENDEL - TX



~230V  IP20   1,5 m  0,8500  0,5 m  



pendant - round - with 1,5m textile cable and strain relief on lampholder's side  
 Pendelleuchte - rund - mit 1,5m Textilkabel und Zugentlastung an Fassung

Ref	CW	NW	WW
1842C.300.1M.TX1			
1842C.300.2M.TX2			
1842C.300.45.TX4			

**Lamp type**  
 1x LED AC 700lm CRI92 max. 9,5W  230V

**Dimensions**  
 Ø60xH300  36 - Cable 1500

**Options**  
 055B - ROSETTE for textile cable

built-up



## 1842.AC.450/.. - MERO PENDEL - TX



~230V  IP20   1,5 m  1,2500  0,5 m  



pendant - round - with 1,5m textile cable and strain relief on lampholder's side  
 Pendelleuchte - rund - mit 1,5m Textilkabel und Zugentlastung an Fassung

Ref	CW	NW	WW
1842C.450.1M.TX1			
1842C.450.2M.TX2			
1842C.450.45.TX4			

**Lamp type**  
 1x LED AC 700lm CRI92 max. 9,5W  230V

**Dimensions**  
 Ø60xH450  36 - Cable 1500

**Options**  
 055B - ROSETTE for textile cable

built-up

## 1842.AC.500/.. - MERO PENDEL - TX



~230V  IP20   1,5 m  0,5 m  



pendant - round - with 1,5m textile cable and strain relief on lampholder's side  
 Pendelleuchte - rund - mit 1,5m Textilkabel und Zugentlastung an Fassung

Ref	CW	NW	WW
1842C.500.1M.TX1			
1842C.500.2M.TX2			
1842C.500.45.TX4			

**Lamp type**  
 1x LED AC 700lm CRI92 max. 9,5W  230V

**Dimensions**  
 Ø60xH500  36 - Cable 1500

**Options**  
 055B - ROSETTE for textile cable

built-up



# INDOOR | Ceiling UP | Pendants | MERO

All M10 spotlights and pendants can be combined with bases (built-in & built-up) and Juba bases as preferred.

Alle M10 Aufbaustrahler und Pendelleuchten können mit Rosetten (In- & Aufbau) und Juba Basen nach Wahl kombiniert werden.

PENDANTS

## 1843.E27.250/.. - MERO PENDEL - TX

~230V



IP20



1,5 m



0,5 m



05.20.02



pendant - square - with 1,5m textile cable and strain relief on lampholder's side  
 Pendelleuchte - viereckig - mit 1,5m Textilkabel und Zugentlastung an Fassung

### Ref

1843.E27.250.1M.TX1 white tex  
 1843.E27.250.2M.TX2 black tex  
 1843.E27.250.45.TX4 sun gold

### Lamp type

1x G125 E27 max. 6W A+ - E 230V

or 1x G95 E27 max. 6W A+ - E 230V

### Dimensions

L60xB60xH250 - Cable 1500

### Options

055B - ROSETTE for textile cable

### Materials

aluminium 1M | 2M | 45

built-up

## 1843.E27.300/.. - MERO PENDEL - TX

~230V



IP20



1,5 m



0,5 m



05.20.02



pendant - square - with 1,5m textile cable and strain relief on lampholder's side  
 Pendelleuchte - viereckig - mit 1,5m Textilkabel und Zugentlastung an Fassung

### Ref

1843.E27.300.1M.TX1 white tex  
 1843.E27.300.2M.TX2 black tex  
 1843.E27.300.45.TX4 sun gold

### Lamp type

1x G125 E27 max. 6W A+ - E 230V

or 1x G95 E27 max. 6W A+ - E 230V

### Dimensions

L60xB60xH300 - Cable 1500

### Options

055B - ROSETTE for textile cable

### Materials

aluminium 1M | 2M | 45

built-up

## 1843.E27.450/.. - MERO PENDEL - TX

~230V



IP20



1,5 m



0,5 m



05.20.02



pendant - square - with 1,5m textile cable and strain relief on lampholder's side  
 Pendelleuchte - viereckig - mit 1,5m Textilkabel und Zugentlastung an Fassung

### Ref

1843.E27.450.1M.TX1 white tex  
 1843.E27.450.2M.TX2 black tex  
 1843.E27.450.45.TX4 sun gold

### Lamp type

1x G125 E27 max. 6W A+ - E 230V

or 1x G95 E27 max. 6W A+ - E 230V

### Dimensions

L60xB60xH450 - Cable 1500

### Options

055B - ROSETTE for textile cable







### Materials



aluminium 1M | 2M | 45

built-up

All M10 spotlights and pendants can be combined with bases (built-in & built-up) and Juba bases as preferred.

Alle M10 Aufbaustrahler und Pendelleuchten können mit Rosetten (In- & Aufbau) und Juba Basen nach Wahl kombiniert werden.

**1844.ES50.250/.. - MERO PENDEL - TX** ~230V  IP20   1,5 m  0,5 m  

pendant - square - with 1,5m textile cable and strain relief on lampholder's side  
 Pendelleuchte - viereckig - mit 1,5m Textilkabel und Zugentlastung an Fassung

**Lamp type**  
 1x QPAR 51 GU10 max. 20W A+ - E 230V







**Dimensions**  
 L60xB60xH250 - Cable 1500



**Options**  
 055B - ROSETTE for textile cable

**Materials**  
 aluminium 1M | 2M | 45

**Ref**  
 1844.ES50.250.1M.TX1 white tex  
 1844.ES50.250.2M.TX2 black tex  
 1844.ES50.250.45.TX4 sun gold

*built-up*

**1844.ES50.300/.. - MERO PENDEL - TX** ~230V  IP20   1,5 m  0,5 m  

pendant - square - with 1,5m textile cable and strain relief on lampholder's side  
 Pendelleuchte - viereckig - mit 1,5m Textilkabel und Zugentlastung an Fassung

**Lamp type**  
 1x QPAR 51 GU10 max. 20W A+ - E 230V







**Dimensions**  
 L60xB60xH300 - Cable 1500



**Options**  
 055B - ROSETTE for textile cable

**Materials**  
 aluminium 1M | 2M | 45

**Ref**  
 1844.ES50.300.1M.TX1 white tex  
 1844.ES50.300.2M.TX2 black tex  
 1844.ES50.300.45.TX4 sun gold

*built-up*

**1844.ES50.450/.. - MERO PENDEL - TX** ~230V  IP20   1,5 m  0,5 m  

pendant - square - with 1,5m textile cable and strain relief on lampholder's side  
 Pendelleuchte - viereckig - mit 1,5m Textilkabel und Zugentlastung an Fassung

**Lamp type**  
 1x QPAR 51 GU10 max. 20W A+ - E 230V

**Dimensions**  
 L60xB60xH450 - Cable 1500

**Options**  
 055B - ROSETTE for textile cable

**Materials**  
 aluminium 1M | 2M | 45

**Ref**  
 1844.ES50.450.1M.TX1 white tex  
 1844.ES50.450.2M.TX2 black tex  
 1844.ES50.450.45.TX4 sun gold

*built-up*

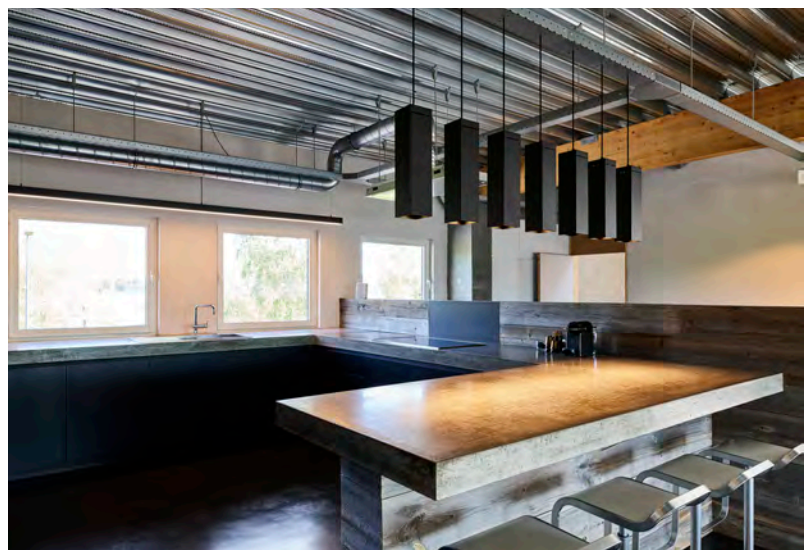

PENDANTS



## INDOOR | Ceiling UP | Pendants | MERO

All M10 spotlights and pendants can be combined with bases (built-in & built-up) and Juba bases as preferred.

Alle M10 Aufbaustrahler und Pendelleuchten können mit Rosetten (In- & Aufbau) und Juba Basen nach Wahl kombiniert werden.

### 1846.AC.250/.. - MERO PENDEL - TX



~230V  IP20    1,5 m  0,5 m  





pendant - square - with 1,5m textile cable and strain relief on lampholder's side  
 Pendelleuchte - viereckig - mit 1,5m Textilkabel und Zugentlastung an Fassung

Ref	CW	NW	WW
1846C.250.1M.TX1			
1846C.250.2M.TX2			
1846C.250.45.TX4			

#### Lamp type

 1x LED AC 700lm CRI92 max. 9,5W  230V

#### Dimensions

 L60xB60xH250  36 - Cable 1500

#### Options

055B - ROSETTE for textile cable

built-up

### 1846.AC.300/.. - MERO PENDEL - TX



~230V  IP20    1,5 m  0,5 m  



pendant - square - with 1,5m textile cable and strain relief on lampholder's side  
 Pendelleuchte - viereckig - mit 1,5m Textilkabel und Zugentlastung an Fassung

Ref	CW	NW	WW
1846C.300.1M.TX1			
1846C.300.2M.TX2			
1846C.300.45.TX4			

#### Lamp type

 1x LED AC 700lm CRI92 max. 9,5W  230V

#### Dimensions

 L60xB60xH300  36 - Cable 1500

#### Options

055B - ROSETTE for textile cable

built-up

### 1846.AC.450/.. - MERO PENDEL - TX

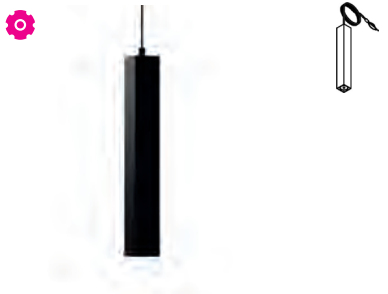

~230V  IP20    1,5 m  0,5 m  





pendant - square - with 1,5m textile cable and strain relief on lampholder's side  
 Pendelleuchte - viereckig - mit 1,5m Textilkabel und Zugentlastung an Fassung

Ref	CW	NW	WW
1846C.450.1M.TX1			
1846C.450.2M.TX2			
1846C.450.45.TX4			

#### Lamp type

 1x LED AC 700lm CRI92 max. 9,5W  230V

#### Dimensions

 L60xB60xH450  36 - Cable 1500







#### Options



055B - ROSETTE for textile cable

built-up

All M10 spotlights and pendants can be combined with bases (built-in & built-up) and Juba bases as preferred.



Alle M10 Aufbaustrahler und Pendelleuchten können mit Rosetten (In- & Aufbau) und Juba Basen nach Wahl kombiniert werden.



**1847.E27.250/.. - MERO PENDEL BRASS - TX** ~230V  IP20    1,5 m  0,5 m  

pendant - round - with 1,5m textile cable and strain relief on lampholder's side  
 Pendelleuchte - rund - mit 1,5m Textilkabel und Zugentlastung an Fassung

**Lamp type**

 1x G125 E27 max. 6W  -  230V

or  1x G95 E27 max. 10,5W  -  230V

**Dimensions**

 Ø54xH250 - Cable 1500

**Options**

055B - ROSETTE for textile cable







**Materials**



brass 16

**Ref**

1847.E27.250.16.TXM satin gold



*built-up*



**1847.E27.300/.. - MERO PENDEL BRASS - TX** ~230V  IP20    1,5 m  0,5 m  

pendant - round - with 1,5m textile cable and strain relief on lampholder's side  
 Pendelleuchte - rund - mit 1,5m Textilkabel und Zugentlastung an Fassung

**Lamp type**

 1x G125 E27 max. 6W  -  230V

or  1x G95 E27 max. 10,5W  -  230V

**Dimensions**

 Ø54xH300 - Cable 1500

**Options**

055B - ROSETTE for textile cable







**Materials**



brass 16

**Ref**

1847.E27.300.16.TXM satin gold



*built-up*



**1847.E27.450/.. - MERO PENDEL BRASS - TX** ~230V  IP20    1,5 m  0,5 m  

pendant - round - with 1,5m textile cable and strain relief on lampholder's side  
 Pendelleuchte - rund - mit 1,5m Textilkabel und Zugentlastung an Fassung

**Lamp type**

 1x G125 E27 max. 6W  -  230V

or  1x G95 E27 max. 10,5W  -  230V

**Dimensions**

 Ø54xH450 - Cable 1500

**Options**

055B - ROSETTE for textile cable

**Materials**

brass 16

**Ref**

1847.E27.450.16.TXM satin gold

*built-up*

## INDOOR | Ceiling UP | Pendants | MERO

All M10 spotlights and pendants can be combined with bases (built-in & built-up) and Juba bases as preferred.

Alle M10 Aufbaustrahler und Pendelleuchten können mit Rosetten (In- & Aufbau) und Juba Basen nach Wahl kombiniert werden.

### 1833.ES50.125/.. - MERO PENDEL BRASS - TX

~230V



IP20



1,5 m



0,5 m



pendant - round - with 1,5m textile cable and strain relief on lampholder's side  
 Pendelleuchte - rund - mit 1,5m Textilkabel und Zugentlastung an Fassung

Ref

1833.ES50.125.16.TXM satin gold

#### Lamp type

1x QPAR 51 GU10 max. 20W A+ - E 230V

#### Dimensions

Ø54xH125 - Cable 1500

#### Options

055B - ROSETTE for textile cable

#### Materials

brass 16

built-up

### 1833.ES50.250/.. - MERO PENDEL BRASS - TX

~230V



IP20



1,5 m



0,5 m



pendant - round - with 1,5m textile cable and strain relief on lampholder's side  
 Pendelleuchte - rund - mit 1,5m Textilkabel und Zugentlastung an Fassung

Ref

1833.ES50.250.16.TXM satin gold

#### Lamp type

1x QPAR 51 GU10 max. 20W A+ - E 230V

#### Dimensions

Ø54xH250 - Cable 1500

#### Options

055B - ROSETTE for textile cable

#### Materials

brass 16

built-up

### 1833.ES50.300/.. - MERO PENDEL BRASS - TX

~230V



IP20



1,5 m



1,500



0,5 m



pendant - round - with 1,5m textile cable and strain relief on lampholder's side  
 Pendelleuchte - rund - mit 1,5m Textilkabel und Zugentlastung an Fassung

Ref

1833.ES50.300.16.TXM satin gold

#### Lamp type

1x QPAR 51 GU10 max. 20W A+ - E 230V

#### Dimensions

Ø54xH300 - Cable 1500

#### Options

055B - ROSETTE for textile cable

#### Materials

brass 16

built-up

### 1833.ES50.450/.. - MERO PENDEL BRASS - TX

~230V



IP20



1,5 m



1,2000



0,5 m



pendant - round - with 1,5m textile cable and strain relief on lampholder's side  
 Pendelleuchte - rund - mit 1,5m Textilkabel und Zugentlastung an Fassung

Ref

1833.ES50.450.16.TXM satin gold

#### Lamp type

1x QPAR 51 GU10 max. 20W A+ - E 230V

#### Dimensions

Ø54xH450 - Cable 1500

#### Options

055B - ROSETTE for textile cable









#### Materials

brass 16

built-up

All M10 spotlights and pendants can be combined with bases (built-in & built-up) and Juba bases as preferred.

Alle M10 Aufbaustrahler und Pendelleuchten können mit Rosetten (In- & Aufbau) und Juba Basen nach Wahl kombiniert werden.

**1833.ES50.500/.. - MERO PENDEL BRASS - TX** ~230V  IP20    1,5 m  0,9200  0,5 m  05.20.02 







*built-up*



pendant - round - with 1,5m textile cable and strain relief on lampholder's side  
 Pendelleuchte - rund - mit 1,5m Textilkabel und Zugentlastung an Fassung









**Ref**  
1833.ES50.500.16.TXM satin gold

**Lamp type**  
 1x QPAR 51 GU10 max. 20W  -  230V

**Dimensions**  
 Ø54xH500 - Cable 1500

**Options**  
055B - ROSETTE for textile cable

**Materials**  
brass 16

**1833.ES50.675/.. - MERO PENDEL BRASS - TX** ~230V  IP20    1,5 m  0,9200  0,5 m  05.20.02 







*built-up*



pendant - round - with 1,5m textile cable and strain relief on lampholder's side  
 Pendelleuchte - rund - mit 1,5m Textilkabel und Zugentlastung an Fassung









**Ref**  
1833.ES50.675.16.TXM satin gold

**Lamp type**  
 1x QPAR 51 GU10 max. 20W  -  230V

**Dimensions**  
 Ø54xH675 - Cable 1500

**Options**  
055B - ROSETTE for textile cable

**Materials**  
brass 16

**1833.ES50.900/.. - MERO PENDEL BRASS - TX** ~230V  IP20    1,5 m  0,9200  0,5 m  05.20.02 







*built-up*



pendant - round - with 1,5m textile cable and strain relief on lampholder's side  
 Pendelleuchte - rund - mit 1,5m Textilkabel und Zugentlastung an Fassung

**Ref**  
1833.ES50.900.16.TXM satin gold

**Lamp type**  
 1x QPAR 51 GU10 max. 20W  -  230V

**Dimensions**  
 Ø54xH900 - Cable 1500

**Options**  
055B - ROSETTE for textile cable

**Materials**  
brass 16



# INDOOR | Ceiling UP | Pendants | MERO

All M10 spotlights and pendants can be combined with bases (built-in & built-up) and Juba bases as preferred.

Alle M10 Aufbaustrahler und Pendelleuchten können mit Rosetten (In- & Aufbau) und Juba Basen nach Wahl kombiniert werden.

## 1823.AC.125/.. - MERO PENDEL BRASS - TX

~230V



IP20



1,5 m



0,5 m



pendant - round - with 1,5m textile cable and strain relief on lampholder's side  
 Pendelleuchte - rund - mit 1,5m Textilkabel und Zugentlastung an Fassung

Ref

1823C.125.16.TXM

CW | NW | WW

### Lamp type

1x LED AC 700lm CRI92 max. 9,5W **A+** 230V

### Dimensions

Ø54xH125 / 36 - Cable 1500

### Options

055B - ROSETTE for textile cable

built-up

## 1823.AC.250/.. - MERO PENDEL BRASS - TX

~230V



IP20



1,5 m



0,5 m



pendant - round - with 1,5m textile cable and strain relief on lampholder's side  
 Pendelleuchte - rund - mit 1,5m Textilkabel und Zugentlastung an Fassung

Ref

1823C.250.16.TXM

CW | NW | WW

### Lamp type

1x LED AC 700lm CRI92 max. 9,5W **A+** 230V

### Dimensions

Ø54xH250 / 36 - Cable 1500

### Options

055B - ROSETTE for textile cable

built-up

## 1823.AC.300/.. - MERO PENDEL BRASS - TX

~230V



IP20



1,5 m



0,5 m



pendant - round - with 1,5m textile cable and strain relief on lampholder's side  
 Pendelleuchte - rund - mit 1,5m Textilkabel und Zugentlastung an Fassung

Ref

1823C.300.16.TXM

CW | NW | WW

### Lamp type

1x LED AC 700lm CRI92 max. 9,5W **A+** 230V

### Dimensions

Ø54xH300 / 36 - Cable 1500

### Options

055B - ROSETTE for textile cable

built-up

## 1823.AC.450/.. - MERO PENDEL BRASS - TX

~230V



IP20



1,5 m



1,3000



0,5 m



pendant - round - with 1,5m textile cable and strain relief on lampholder's side  
 Pendelleuchte - rund - mit 1,5m Textilkabel und Zugentlastung an Fassung

Ref

1823C.450.16.TXM

CW | NW | WW

### Lamp type

1x LED AC 700lm CRI92 max. 9,5W **A+** 230V

### Dimensions

Ø54xH450 / 36 - Cable 1500

### Options

055B - ROSETTE for textile cable

built-up

All M10 spotlights and pendants can be combined with bases (built-in & built-up) and Juba bases as preferred.

Alle M10 Aufbaustrahler und Pendelleuchten können mit Rosetten (In- & Aufbau) und Juba Basen nach Wahl kombiniert werden.

**1823.AC.500/.. - MERO PENDEL BRASS - TX**

~230V  IP20  1,5 m  05.20.50 



pendant - round - with 1,5m textile cable and strain relief on lampholder's side  
 Pendelleuchte - rund - mit 1,5m Textilkabel und Zugentlastung an Fassung

**Ref**  
 1823C.500.16.TXM CW | NW | WW

**Lamptype**  
 1x LED AC 700lm CRI92 max. 9,5W  230V

**Dimensions**  
 Ø54xH500  36 - Cable 1500

**Options**  
 055B - ROSETTE for textile cable

built-up

**1823.AC.675/.. - MERO PENDEL BRASS - TX**



~230V  IP20  1,5 m  05.20.50 



pendant - round - with 1,5m textile cable and strain relief on lampholder's side  
 Pendelleuchte - rund - mit 1,5m Textilkabel und Zugentlastung an Fassung

**Ref**  
 1823C.675.16.TXM CW | NW | WW

**Lamptype**  
 1x LED AC 700lm CRI92 max. 9,5W  230V

**Dimensions**  
 Ø54xH675  36 - Cable 1500

**Options**  
 055B - ROSETTE for textile cable

built-up



**1823.AC.900/.. - MERO PENDEL BRASS - TX**



~230V  IP20  1,5 m  05.20.50 



pendant - round - with 1,5m textile cable and strain relief on lampholder's side  
 Pendelleuchte - rund - mit 1,5m Textilkabel und Zugentlastung an Fassung

**Ref**  
 1823C.900.16.TXM CW | NW | WW

**Lamptype**  
 1x LED AC 700lm CRI92 max. 9,5W  230V

**Dimensions**  
 Ø54xH900  36 - Cable 1500

**Options**  
 055B - ROSETTE for textile cable

built-up

1907.3/.. - MERO

~230V



IP20



1,5 m



0,5 m



pendant - round - with 3x Mero on base Juba  
 Pendelleuchte - rund - mit 3x Mero auf Basis Juba

Lamp type

3x LED AC 700lm CRI92 max. 9,5W **A+** 230V

Dimensions

L900xB60xH1845 - Cable 1500

Base - L900xB45xH45

Tube - Ø60xH300

Ref

1907.3.1M.TX1	CW   NW   WW
1907.3.2M.TX2	CW   NW   WW
1907.3.16.TXM	CW   NW   WW
1907.3.216.TX2	CW   NW   WW
1907.3.216.TXM	CW   NW   WW

built-up

1908.5/.. - MERO

~230V



IP20



1,5 m



0,5 m



pendant - round - with 5x Mero on base Juba  
 Pendelleuchte - rund - mit 5x Mero auf Basis Juba

Lamp type

5x LED AC 700lm CRI92 max. 9,5W **A+** 230V

Dimensions

L1200xB60xH1845 - Cable 1500

Base - L1200xB45xH45

Tube - Ø60xH300





Ref

1908.5.1M.TX1	CW   NW   WW
1908.5.2M.TX2	CW   NW   WW
1908.5.16.TXM	CW   NW   WW
1908.5.216.TX2	CW   NW   WW
1908.5.216.TXM	CW   NW   WW

built-up





1909.5/.. - MERO

~230V  IP20  1,5 m   



pendant - round - with 5x Mero on base Rondobox  
Pendelleuchte - rund - mit 5x Mero auf Basis Rondobox

Lamptype

 5x LED AC 700lm CRI92 max. 9,5W  230V

Dimensions

→ Ø350xH1828 - Cable 1500  
Base - Ø350xH28  
Tube - Ø60xH300

Ref

1909.5.1M.TX1	CW   NW   WW
1909.5.2M.TX2	CW   NW   WW
1909.5.216.TX2	CW   NW   WW
1909.5.216.TXM	CW   NW   WW

built-up



1910.7/.. - MERO

~230V  IP20  1,5 m   



pendant - round - with 7x Mero on base Rondobox  
Pendelleuchte - rund - mit 7x Mero auf Basis Rondobox

Lamptype

 7x LED AC 700lm CRI92 max. 9,5W  230V

Dimensions

→ Ø400xH1828 - Cable 1500  
Base - Ø400xH28  
Tube - Ø60xH300

Ref

1910.7.1M.TX1	CW   NW   WW
1910.7.2M.TX2	CW   NW   WW
1910.7.216.TX2	CW   NW   WW
1910.7.216.TXM	CW   NW   WW

built-up





1916.5/.. - MERO

~230V  IP20  1,5 m   



pendant - round - with 5x Mero on base Rondobox  
Pendelleuchte - rund - mit 5x Mero auf Basis Rondobox

Lamptype

 2x LED AC 700lm CRI92 max. 9,5W  230V  
 3x G95 E27 max. 10,5W  -  230V

Dimensions

→ Ø400xH1828 - 1500  
Base - Ø400xH28  
Tube - Ø60xH300

Materials

aluminium 1M | 2M

Ref

1916.5.1M.TX1.CW	white tex
1916.5.1M.TX1.NW	white tex
1916.5.1M.TX1.WW	white tex
1916.5.2M.TX2.CW	black tex
1916.5.2M.TX2.NW	black tex
1916.5.2M.TX2.WW	black tex
1916.5.216.TXM.CW	black - gold
1916.5.216.TXM.NW	black - gold
1916.5.216.TXM.WW	black - gold

built-up





1927.11/.. - MERO

~230V  IP20  1,5 m   



pendant - round - with 11x Mero on base Rondobox  
Pendelleuchte - rund - mit 11x Mero auf Basis Rondobox

Lamptype

 6x LED AC 700lm CRI92 max. 9,5W  230V  
 5x G95 E27 max. 10,5W  -  230V

Dimensions

→ Ø500xH1828 - 1500  
Base - Ø500xH27  
Tube - Ø60xH300

Materials

aluminium 1M | 2M

Ref

1927.11.1M.TX1.CW	white tex
1927.11.1M.TX1.NW	white tex
1927.11.1M.TX1.WW	white tex
1927.11.2M.TX2.CW	black tex
1927.11.2M.TX2.NW	black tex
1927.11.2M.TX2.WW	black tex
1927.11.216.TXM.CW	black - gold
1927.11.216.TXM.NW	black - gold
1927.11.216.TXM.WW	black - gold

built-up

5157.2E.3M/.. - MOBY GLASS

~230V IP20 1,5 m 0,5 m 05.20.50 CE



pendant - combination 2x Moby and 3x Mero - 1,5m textile cable  
 Pendelleuchte - Kombination 2x Moby und 3x Mero - 1,5m Textilkabel

Lamp type

- 2x A60 E27 max. 60W **A** - **E** 230V
- 3x LED AC 700lm CRI92 max. 9,5W **A+** 230V

Dimensions

L1400xB250xH1755 - Cable 1500  
 Base - L1400xB50xH40  
 Glass - Ø200  
 Tube - Ø60xH300

Materials

aluminium 1M | 2M  
 brass 16

Ref cat (LONG)

- 5157.2E.3M.1M.TR.TX1 white tex
- 5157.2E.3M.1M.ST.TX1 white tex
- 5157.2E.3M.2M.TR.TX2 black tex
- 5157.2E.3M.2M.ST.TX2 black tex
- 5157.2E.3M.16.TR.TXM satin gold
- 5157.2E.3M.216.TR.TX2 black - gold
- 5157.2E.3M.216.TR.TXM black - gold

built-up

5158.2C.3M/.. - MOBY GLASS

~230V IP20 1,5 m 0,5 m 05.20.50 CE

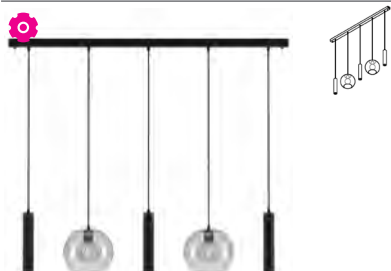

pendant - combination 2x Moby and 3x Mero - 1,5m textile cable  
 Pendelleuchte - Kombination 2x Moby und 3x Mero - 1,5m Textilkabel

Lamp type

- 2x A60 E27 max. 60W **A** - **E** 230V
- 3x LED AC 700lm CRI92 max. 9,5W **A+** 230V

Dimensions

L1400xB250xH1755 - Cable 1500  
 Base - L1400xB50xH40  
 Glass - Ø250  
 Glass - Ø180

Materials

aluminium 1M | 2M  
 brass 16

Ref

- 5158.2C.3M.1M.TR.TX1 white tex
- 5158.2C.3M.1M.ST.TX1 white tex
- 5158.2C.3M.2M.TR.TX2 black tex
- 5158.2C.3M.2M.ST.TX2 black tex
- 5158.2C.3M.16.TR.TXM satin gold
- 5158.2C.3M.216.TR.TX2 black - gold
- 5158.2C.3M.216.TR.TXM black - gold

built-up





All M10 spotlights and pendants can be combined with bases (built-in & built-up) and Juba bases as preferred.

Alle M10 Aufbaustrahler und Pendelleuchten können mit Rosetten (In- & Aufbau) und Juba Basen nach Wahl kombiniert werden.

**3987.M.B3/.. - JACOB M - B3**

=350mA    IP20    0,8 m  0,5 m  



pendant with swivel - without LED driver  
Pendelleuchte mit Kugelgelenk - ohne Driver LED

**Lamp type**  
1x led 467lm CRI80 max. 3,8W  -  350mA

**Dimensions**  
Ø40xH85  48° reflector - Bar 800

**Options**  
020.B3.D8,3 - ROSETTE

Ref	
3987.M.B3.1M	NW   WW
3987.M.B3.2M	NW   WW
3987.M.B3.14	NW   WW

built-up

**3987.M.TX/.. - JACOB M - TX**

=350mA    IP20    2 m  0,2600  0,5 m  



pendant - with 2m textile cable and strain relief on lampholder's side - without LED driver  
Pendelleuchte - ohne Driver LED

**Lamp type**  
1x led 467lm CRI80 max. 3,8W  -  350mA

**Dimensions**  
Ø40xH85  48° reflector - Cable 2000

**Options**  
055B - ROSETTE for textile cable

Ref	
3987.M.TX.1M.TX1	NW   WW
3987.M.TX.2M.TX2	NW   WW
3987.M.TX.14.TX11	NW   WW

built-up



PENDANTS

# INDOOR | Ceiling UP | Pendants | JACOB

All M10 spotlights and pendants can be combined with bases (built-in & built-up) and Juba bases as preferred.

Alle M10 Aufbaustrahler und Pendelleuchten können mit Rosetten (In- & Aufbau) und Juba Basen nach Wahl kombiniert werden.



## 3988.300/.. - JACOB PENDEL - TX

=350mA  IP20   1,5 m  0,7500  0,5 m  



pendant - round - with 1,5m textile cable and strain relief on lampholder's side - without LED driver  
 Pendelleuchte - rund - mit 1,5m Textilkabel und Zugentlastung an Fassung - ohne Driver LED

### Lamp type

 1x led 467lm CRI80 max. 3,8W  -  350mA

### Dimensions

 Ø40xH300  48° reflector - Cable 1500

### Ref

3988.300.1M.TX1	NW   WW
3988.300.2M.TX2	NW   WW
3988.300.29.TX2	NW   WW
3988.300.49.TX1	NW   WW

built-up



## 3988.400/.. - JACOB PENDEL - TX

=350mA  IP20   1,5 m  0,8500  0,5 m  



pendant - round - with 1,5m textile cable and strain relief on lampholder's side - without LED driver  
 Pendelleuchte - rund - mit 1,5m Textilkabel und Zugentlastung an Fassung - ohne Driver LED

### Lamp type

 1x led 467lm CRI80 max. 3,8W  -  350mA

### Dimensions

 Ø40xH400  48° reflector - Cable 1500

### Ref

3988.400.1M.TX1	NW   WW
3988.400.2M.TX2	NW   WW
3988.400.29.TX2	NW   WW
3988.400.49.TX1	NW   WW

built-up



## 3988.500/.. - JACOB PENDEL - TX

=350mA  IP20   1,5 m  1,6000  0,5 m  



pendant - round - with 1,5m textile cable and strain relief on lampholder's side - without LED driver  
 Pendelleuchte - rund - mit 1,5m Textilkabel und Zugentlastung an Fassung - ohne Driver LED

### Lamp type

 1x led 467lm CRI80 max. 3,8W  -  350mA

### Dimensions

 Ø40xH500  48° reflector - Cable 1500

### Ref

3988.500.1M.TX1	NW   WW
3988.500.2M.TX2	NW   WW
3988.500.29.TX2	NW   WW
3988.500.49.TX1	NW   WW

built-up

All M10 spotlights and pendants can be combined with bases (built-in & built-up) and Juba bases as preferred.

Alle M10 Aufbaustrahler und Pendelleuchten können mit Rosetten (In- & Aufbau) und Juba Basen nach Wahl kombiniert werden.



**3980.300/.. - JACOB BRASS - TX**

=350mA  IP20    1,5 m  0,9700  0,5 m  05.20.50 



pendant - round - with 1,5m textile cable and strain relief on lampholder's side - without LED driver  
 Pendelleuchte - rund - mit 1,5m Textilkabel und Zugentlastung an Fassung - ohne Driver LED

**Ref**  
 3980.300.16.TXM NW | WW

**Lamp type**  
 1x led 467lm CRI80 max. 3,8W  - **350mA**

**Dimensions**  
 Ø40xH300  48° reflector - Cable 1500

built-up



**3980.400/.. - JACOB BRASS - TX**

=350mA  IP20    1,5 m  0,9700  0,5 m  05.20.50 



pendant - round - with 1,5m textile cable and strain relief on lampholder's side - without LED driver  
 Pendelleuchte - rund - mit 1,5m Textilkabel und Zugentlastung an Fassung - ohne Driver LED

**Ref**  
 3980.400.16.TXM NW | WW

**Lamp type**  
 1x led 467lm CRI80 max. 3,8W  - **350mA**

**Dimensions**  
 Ø40xH400  48° reflector - Cable 1500

built-up



**3980.500/.. - JACOB BRASS - TX**

=350mA  IP20    1,5 m  1,5000  0,5 m  05.20.50 



pendant - round - with 1,5m textile cable and strain relief on lampholder's side - without LED driver  
 Pendelleuchte - rund - mit 1,5m Textilkabel und Zugentlastung an Fassung - ohne Driver LED





**Ref**  
 3980.500.16.TXM NW | WW

**Lamp type**  
 1x led 467lm CRI80 max. 3,8W  - **350mA**

**Dimensions**  
 Ø40xH500  48° reflector - Cable 1500

built-up

1922.3/.. - JACOB

~230V  IP20   



built-up

pendant - with 3x Jacob on base Juba - with LED driver  
 Pendelleuchte - mit 3x Jacob auf Basis Juba - mit Driver LED



**Lamp type**  
 3x led 639lm CRI80 max. 5,6W A - A+ 500mA

**Dimensions**  
 L900xB45xH1945 - Cable 1500  
 Base - L900xB45xH45  
 Tube - Ø40xH400

**Materials**  
 aluminium 1M | 2M  
 brass 16

Ref	
1922.3.1M.TX1.NW	white tex
1922.3.1M.TX1.WW	white tex
1922.3.2M.TX2.WW	black tex
1922.3.2M.TX2.NW	black tex
1922.3.16.TXM.NW	satin gold
1922.3.16.TXM.WW	satin gold
1922.3.216.TX2.NW	black - gold
1922.3.216.TX2.WW	black - gold
1922.3.216.TXM.NW	black - gold
1922.3.216.TXM.WW	black - gold

1923.5/.. - JACOB

~230V  IP20   



built-up

pendant - with 5x Jacob on base Juba - with LED driver  
 Pendelleuchte - mit 5x Jacob auf Basis Juba - mit Driver LED



**Lamp type**  
 5x led 639lm CRI80 max. 5,6W A - A+ 500mA

**Dimensions**  
 L1200xB45xH1945 - Cable 1500  
 Base - L1200xB45xH45  
 Tube - Ø40xH400

**Materials**  
 aluminium 1M | 2M  
 brass 16

Ref	
1923.5.1M.TX1.NW	white tex
1923.5.1M.TX1.WW	white tex
1923.5.2M.TX2.WW	black tex
1923.5.2M.TX2.NW	black tex
1923.5.16.TXM.NW	satin gold
1923.5.16.TXM.WW	satin gold
1923.5.216.TX2.NW	black - gold
1923.5.216.TX2.WW	black - gold
1923.5.216.TXM.NW	black - gold
1923.5.216.TXM.WW	black - gold

1924.7/.. - JACOB

~230V  IP20   

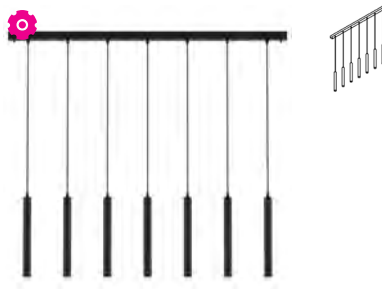

built-up

pendant - with 7x Jacob on base Juba - with LED driver  
 Pendelleuchte - mit 7x Jacob auf Basis Juba - mit Driver LED







**Lamp type**  
 7x led 639lm CRI80 max. 5,6W A - A+ 500mA

**Dimensions**  
 L1400xB45xH1945 - Cable 1500  
 Base - L1400xB45xH45  
 Tube - Ø40xH400

**Materials**  
 aluminium 1M | 2M  
 brass 16

Ref	
1924.7.1M.TX1.NW	white tex
1924.7.1M.TX1.WW	white tex
1924.7.2M.TX2.WW	black tex
1924.7.2M.TX2.NW	black tex
1924.7.16.TXM.NW	satin gold
1924.7.16.TXM.WW	satin gold
1924.7.216.TX2.NW	black - gold
1924.7.216.TX2.WW	black - gold
1924.7.216.TXM.NW	black - gold
1924.7.216.TXM.WW	black - gold

1925.5/.. - JACOB

~230V   IP20     



pendant - with 5x Jacob on base Rondobox - with LED driver  
 Pendelleuchte - mit 5x Jacob auf Basis Rondobox - mit Driver LED

**Lamp type**  
 5x led 639lm CRI80 max. 5,6W  -  500mA





**Dimensions**  
 Ø350xH1945 - Cable 1500  
 Base - Ø350xH28  
 Tube - Ø40xH400

**Materials**  
 aluminium 1M | 2M

Ref	
1925.5.1M.TX1.NW	white tex
1925.5.1M.TX1.WW	white tex
1925.5.2M.TX2.NW	black tex
1925.5.2M.TX2.WW	black tex
1925.5.216.TX2.NW	black - gold
1925.5.216.TX2.WW	black - gold
1925.5.216.TXM.NW	black - gold
1925.5.216.TXM.WW	black - gold

built-up

1926.7/.. - JACOB

~230V   IP20     



pendant - with 7x Jacob on base Rondobox - with LED driver  
 Pendelleuchte - mit 7x Jacob auf Basis Rondobox - mit Driver LED

**Lamp type**  
 5x led 639lm CRI80 max. 5,6W  -  500mA

**Dimensions**  
 Ø400xH1945 - Cable 1500  
 Base - Ø400xH28  
 Tube - Ø40xH400

**Materials**  
 aluminium 1M | 2M

Ref	
1926.7.1M.TX1.NW	white tex
1926.7.1M.TX1.WW	white tex
1926.7.2M.TX2.NW	black tex
1926.7.2M.TX2.WW	black tex
1926.7.216.TX2.NW	black - gold
1926.7.216.TX2.WW	black - gold
1926.7.216.TXM.NW	black - gold
1926.7.216.TXM.WW	black - gold

built-up



PENDANTS



4977.7.LED/.. - BACH



~230V   IP20   1,5 m   



pendant - oval base with 7 pendants - with LED driver  
 Pendelleuchte - ovale Basis mit 7 Hängelampen - mit Driver LED

Lamp type

4x LED AC 700lm CRI92 max. 9,5W  230V

3x led 1055lm CRI90 max. 13W  -  1050mA

Dimensions

g 38° reflector L800xB270xH30

△ 38° reflector L800xB270xH30

Base - L800xB270xH30

Cable - L1500

Materials aluminium 1M | 2M

Ref

4977.7.LED.1M.1M.NW	white tex
4977.7.LED.1M.1M.WW	white tex
4977.7.LED.1M.16.NW	white tex
4977.7.LED.1M.16.WW	white tex
4977.7.LED.2M.2M.NW	black tex
4977.7.LED.2M.2M.WW	black tex
4977.7.LED.2M.16.NW	black tex
4977.7.LED.2M.16.WW	black tex

built-up

PENDANTS

4977.13.LED/.. - BACH



~230V   IP20   1,5 m   



pendant - oval base with 13 pendants - with LED driver  
 Pendelleuchte - ovale Basis mit 13 Hängelampen - mit Driver LED

Lamp type

7x LED AC 700lm CRI92 max. 9,5W  230V

6x led 1055lm CRI90 max. 13W  -  1050mA

Dimensions

g 38° reflector L800xB270xH30

△ 38° reflector L800xB270xH30

Base - L800xB270xH30

Cable - L1500

Materials aluminium 1M | 2M

Ref

4977.13.LED.1M.NW	white tex
4977.13.LED.1M.WW	white tex
4977.13.LED.1M.16.NW	white tex
4977.13.LED.1M.16.WW	white tex
4977.13.LED.2M.NW	black tex
4977.13.LED.2M.WW	black tex
4977.13.LED.2M.16.NW	black tex
4977.13.LED.2M.16.WW	black tex

built-up



5227.200/.. - FLOU - TX

~230V  IP20   1,5 m  0,9600  0,5 m  



built-up

pendant - round - down - with 1,5m textile cable and strain relief on lampholder's side  
 Pendelleuchte - rund - down - mit 1,5m Textilkabel und Zugentlastung an Fassung

**Lamp type**  
 1x LED 850lm CRI90 max. 10W 230V

**Dimensions**  
 Ø90xH200  $\wedge$  30° reflector - Cable 1500

**Options**  
 054B - ROSETTE for textile cable  
 055B - ROSETTE for textile cable

**Ref**

5227.200.1M.TX1	TX1   TX1
5227.200.2M.1M.TX2	TX2   TX2
5227.200.2M.TX2	TX2   TX2
5227.200.2M.45.TX2	TX2   TX2
5227.200.45.45.TX4	TX4   TX4

5227.300/.. - FLOU - TX

~230V  IP20   1,5 m  1,1000  0,5 m  



built-up

pendant - round - down - with 1,5m textile cable and strain relief on lampholder's side  
 Pendelleuchte - rund - down - mit 1,5m Textilkabel und Zugentlastung an Fassung

**Lamp type**  
 1x LED 850lm CRI90 max. 10W 230V

**Dimensions**  
 Ø90xH300  $\wedge$  30° reflector - Cable 1500

**Options**  
 054B - ROSETTE for textile cable  
 055B - ROSETTE for textile cable

**Ref**

5227.300.1M.TX1	TX1   TX1
5227.300.2M.1M.TX2	TX2   TX2
5227.300.2M.TX2	TX2   TX2
5227.300.2M.45.TX2	TX2   TX2
5227.300.45.45.TX4	TX4   TX4

5227.400/.. - FLOU - TX

~230V  IP20   1,5 m  1,2000  0,5 m  



built-up

pendant - round - down - with 1,5m textile cable and strain relief on lampholder's side  
 Pendelleuchte - rund - down - mit 1,5m Textilkabel und Zugentlastung an Fassung

**Lamp type**  
 1x LED 850lm CRI90 max. 10W 230V

**Dimensions**  
 Ø90xH400  $\wedge$  30° reflector - Cable 1500

**Options**  
 054B - ROSETTE for textile cable  
 055B - ROSETTE for textile cable

**Ref**

5227.400.1M.TX1	TX1   TX1
5227.400.2M.1M.TX2	TX2   TX2
5227.400.2M.TX2	TX2   TX2
5227.400.2M.45.TX2	TX2   TX2
5227.400.45.45.TX4	TX4   TX4

1836.300.ES50/.. - BACCHUS - TX

~230V IP20 1,5 m 0,8450 0,5 m 05.20.02 CE

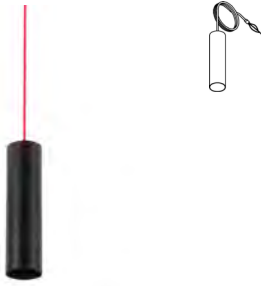

built-up

pendant - with 1,5m textile cable and strain relief on lampholder's side  
 Pendelleuchte - mit 1,5m Textilkabel und Zugentlastung an Fassung

**Ref**  
 1836.300.ES50.1M.TX1 white tex  
 1836.300.ES50.2M.TX2 black tex  
 1836.300.ES50.2M.TX3 black tex

**Lamp type**  
 1x QPAR 51 GU10 max. 20W A+ - E 230V

**Dimensions**  
 Ø80xH300 40° reflector - Cable 1500

**Options**  
 054B - ROSETTE for textile cable  
 055B - ROSETTE for textile cable

**Materials**  
 aluminium 1M | 2M

1836.450.ES50/.. - BACCHUS - TX

~230V IP20 1,5 m 1,1200 0,5 m 05.20.02 CE

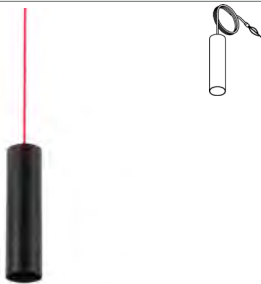

built-up

pendant - with 1,5m textile cable and strain relief on lampholder's side  
 Pendelleuchte - mit 1,5m Textilkabel und Zugentlastung an Fassung

**Ref**  
 1836.450.ES50.1M.TX1 white tex  
 1836.450.ES50.2M.TX2 black tex  
 1836.450.ES50.2M.TX3 black tex

**Lamp type**  
 1x QPAR 51 GU10 max. 20W A+ - E 230V

**Dimensions**  
 Ø80xH450 40° reflector - Cable 1500

**Options**  
 054B - ROSETTE for textile cable  
 055B - ROSETTE for textile cable

**Materials**  
 aluminium 1M | 2M

1836.675.ES50/.. - BACCHUS - TX

~230V IP20 1,5 m 1,8100 0,5 m 05.20.02 CE

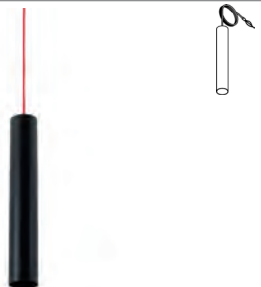

built-up

pendant - with 1,5m textile cable and strain relief on lampholder's side  
 Pendelleuchte - mit 1,5m Textilkabel und Zugentlastung an Fassung

**Ref**  
 1836.675.ES50.1M.TX1 white tex  
 1836.675.ES50.2M.TX2 black tex  
 1836.675.ES50.2M.TX3 black tex

**Lamp type**  
 1x QPAR 51 GU10 max. 20W A+ - E 230V

**Dimensions**  
 Ø80xH675 40° reflector - Cable 1500

**Options**  
 054B - ROSETTE for textile cable  
 055B - ROSETTE for textile cable

**Materials**  
 aluminium 1M | 2M

1836.450/.. - BACCHUS - TX

=500mA IP20 1,5 m 0,5 m



built-up

pendant - with 1,5m textile cable and strain relief on lampholder's side - without LED driver  
 Pendelleuchte - mit 1,5m Textilkabel und Zugentlastung an Fassung - ohne Driver LED

Ref	
1836.450.1M.TX1	NW
1836.450.2M.TX2	NW
1836.450.2M.TX3	NW

**Lamp type**  
 1x Led 965lm CRI80 max. 6,6W - 500mA

**Dimensions**  
 Ø80xH450 40° reflector - Cable 1500  
 Reflector - Ø70

**Options**  
 054B - ROSETTE for textile cable  
 055B - ROSETTE for textile cable

1836.675/.. - BACCHUS - TX

=500mA IP20 1,5 m 1,5300 0,5 m



built-up

pendant - with 1,5m textile cable and strain relief on lampholder's side - without LED driver  
 Pendelleuchte - mit 1,5m Textilkabel und Zugentlastung an Fassung - ohne Driver LED

Ref	
1836.675.1M.TX1	NW
1836.675.2M.TX2	NW
1836.675.2M.TX3	NW

**Lamp type**  
 1x Led 965lm CRI80 max. 6,6W - 500mA

**Dimensions**  
 Ø80xH675 40° reflector - Cable 1500  
 Reflector - Ø70

**Options**  
 054B - ROSETTE for textile cable  
 055B - ROSETTE for textile cable

1836.900/.. - BACCHUS - TX

=500mA IP20 1,5 m 0,5 m



built-up

pendant - with 1,5m textile cable and strain relief on lampholder's side - without LED driver  
 Pendelleuchte - mit 1,5m Textilkabel und Zugentlastung an Fassung - ohne Driver LED

Ref	
1836.900.1M.TX1	NW
1836.900.2M.TX2	NW
1836.900.2M.TX3	NW

**Lamp type**  
 1x Led 965lm CRI80 max. 6,6W - 500mA

**Dimensions**  
 Ø80xH900 40° reflector - Cable 1500  
 Reflector - Ø70

**Options**  
 054B - ROSETTE for textile cable  
 055B - ROSETTE for textile cable

PENDANTS



1835.450/.. - BACCHUS - TX



=500mA   IP20    1,5 m  0,5 m  



pendant - with 1,5m textile cable and strain relief on lampholder's side - without LED driver  
 Pendelleuchte - mit 1,5m Textilkabel und Zugentlastung an Fassung - ohne Driver LED

Ref	
1835.450.1M.TX1	NW
1835.450.2M.TX2	NW
1835.450.2M.TX3	NW

**Lamp type**  
 1x Led 965lm CRI80 max. 6,6W  -  500mA

**Dimensions**  
 Ø80xH450  40° reflector - Cable 1500  
 Reflector - Ø70

**Options**  
 054B - ROSETTE for textile cable  
 055B - ROSETTE for textile cable

*built-up  
 on request red inside*

PENDANTS

1835.450.ES50/.. - BACCHUS - TX



~230V  IP20    1,5 m  0,5 m  



pendant - with 1,5m textile cable and strain relief on lampholder's side  
 Pendelleuchte - mit 1,5m Textilkabel und Zugentlastung an Fassung

Ref	
1835.450.ES50.1M.TX1	white tex
1835.450.ES50.2M.TX2	black tex
1835.450.ES50.2M.TX3	black tex

**Lamp type**  
 1x QPAR 51 GU10 max. 20W  -  230V

**Dimensions**  
 Ø80xH450  40° reflector - Cable 1500  
 Reflector - Ø70

**Options**  
 054B - ROSETTE for textile cable  
 055B - ROSETTE for textile cable

*built-up  
 on request red inside*

**Materials**  
 aluminium 1M | 2M







5070/.. - POLINA PENDEL 3 - B3

~230V IP20 0,6 m 10,4000 0,5 m 05.20.02 CE



built-up

pendant with swivel - rod can be shortened - glass H320  
 Pendelleuchte mit Kugelgelenk - kürzbare Stange - Glas H320

<b>Lamp type</b>	
3x A60 E27 max. 60W <span style="color: green;">A</span> - <span style="color: red;">E</span>	230V
or 3x ST64 E27 max. 60W <span style="color: green;">A</span> - <span style="color: red;">E</span>	230V
<b>Dimensions</b>	
Ø132xH320 - Bar 600	
Base - L1400xB70xH40	
<b>Materials</b>	
brass	16
INOX	32X   63X   64X   31MX   33MX
red copper	56

<b>Ref</b>	
5070.16	satin gold
5070.56	red copper shiny
5070.31MX	white texture
5070.32X	black texture
5070.33MX	brown texture
5070.63X	umbra grey
5070.64X	black grey

5071.B4/.. - POLINA - B3

~230V IP20 0,6 m 2,0200 0,5 m 05.20.02 CE



built-up

pendant with swivel and built-up base - glass H320  
 Pendelleuchte mit Kugelgelenk und Aufbaurossette - Glas H320

<b>Lamp type</b>	
1x ST64 E27 max. 40W <span style="color: green;">A</span> - <span style="color: red;">E</span>	230V
<b>Dimensions</b>	
Ø132xH320 - Bar 600	
Ø70xH38	
<b>Materials</b>	
brass	16
INOX	32X   63X   64X   31MX   33MX
red copper	56

<b>Ref</b>	
5071.B4.16	satin gold
5071.B4.56	red copper shiny
5071.B4.31MX	white texture
5071.B4.32X	black texture
5071.B4.33MX	brown texture
5071.B4.63X	umbra grey
5071.B4.64X	black grey

5072/.. - POLINA PENDEL 3 - B3

~230V IP20 0,6 m 8,3000 0,5 m 05.20.02 CE



built-up

pendant with swivel - rod can be shortened - glass H250  
 Pendelleuchte mit Kugelgelenk - kürzbare Stange - Glas H250

<b>Lamp type</b>	
3x A60 E27 max. 60W <span style="color: green;">A</span> - <span style="color: red;">E</span>	230V
or 3x ST64 E27 max. 60W <span style="color: green;">A</span> - <span style="color: red;">E</span>	230V
<b>Dimensions</b>	
Ø132xH250 - Bar 600	
Base - L1400xB70xH40	
<b>Materials</b>	
brass	16
INOX	32X   63X   64X   31MX   33MX
red copper	56

<b>Ref</b>	
5072.16	satin gold
5072.56	red copper shiny
5072.31MX	white texture
5072.32X	black texture
5072.33MX	brown texture
5072.63X	umbra grey
5072.64X	black grey

5073.B4/.. - POLINA - B3

~230V IP20 0,6 m 2,0900 0,5 m 05.20.02 CE



built-up

pendant with swivel and built-up base - glass H250  
 Pendelleuchte mit Kugelgelenk und Aufbaurossette - Glas H250

<b>Lamp type</b>	
1x ST64 E27 max. 40W <span style="color: green;">A</span> - <span style="color: red;">E</span>	230V
<b>Dimensions</b>	
Ø132xH250 - Bar 600	
Ø70xH38	
<b>Materials</b>	
brass	16
INOX	32X   63X   64X   31MX   33MX
red copper	56

<b>Ref</b>	
5073.B4.16	satin gold
5073.B4.56	red copper shiny
5073.B4.31MX	white texture
5073.B4.32X	black texture
5073.B4.33MX	brown texture
5073.B4.63X	umbra grey
5073.B4.64X	black grey



3071.ZXO.B3/.. - SPAZIO LED - B3

~230V  IP20    0,8 m  0,5 m  





pendant with swivel - rod can be shortened  
Pendelleuchte mit Kugelgelenk - kürzbare Stange

Lamp type

 1x LED 850lm CRI90 max. 10W 230V

Dimensions

 Ø200xH100 - 800  
 Ø54xH60

Ref

3071.ZXO.B3.1M	NW   WW
3071.ZXO.B3.2M	NW   WW
3071.ZXO.B3.14	NW   WW
3071.ZXO.B3.29	NW   WW

built-up



3071.XTM.B3/.. - SPAZIO LED - B3

=500mA   IP20    0,8 m  1,200  0,5 m  





pendant with swivel - rod can be shortened - without LED driver  
Pendelleuchte mit Kugelgelenk - kürzbare Stange - ohne Driver LED

Lamp type

 1x Led 965lm CRI80 max. 6,6W  -  500mA

Dimensions

 Ø200xH100 - Bar 800  
 Ø54xH60

Ref

3071.XTM.B3.1M	NW   WW
3071.XTM.B3.2M	NW   WW
3071.XTM.B3.14	NW   WW
3071.XTM.B3.29	NW   WW

built-up









5114.N/.. - MANON N TRANSPARANT

~230V IP20 2 m 0,5 m 05.20.02 CE



pendant - round - with 2m textile cable and strain relief on lampholder's side  
 Pendelleuchte - rund - mit 2m Textilkabel und Zugentlastung an Fassung

**Lamp type**  
 1x G80 E27 max. 40W **A** - **E** 230V

**Dimensions**  
 Ø180xH180 - Cable 2000

**Materials**  
 glass TR

Ref	
5114.N.TR.TX1.1M	transparent
5114.N.TR.TX2.2M	transparent
5114.N.TR.TX3.2M	transparent
5114.N.TR.TX4.4	transparent
5114.N.TR.TX4.16	transparent
5114.N.TR.TX8.13	transparent
5114.N.TR.TX8.28	transparent
5114.N.TR.TX11.14	transparent
5114.N.TR.TX23.23	transparent
5114.N.TR.TXM.16	transparent
5114.N.TR.TXRK.28	transparent

built-up

5115.Q/.. - MANON Q TRANSPARANT

~230V IP20 2 m 0,5 m 05.20.02 CE



pendant - round - with 2m textile cable and strain relief on lampholder's side  
 Pendelleuchte - rund - mit 2m Textilkabel und Zugentlastung an Fassung

**Lamp type**  
 1x G80 E27 max. 40W **A** - **E** 230V

**Dimensions**  
 Ø320xH130 - Cable 2000

**Materials**  
 glass TR

Ref	
5115.Q.TR.TX1.1M	transparent
5115.Q.TR.TX2.2M	transparent
5115.Q.TR.TX3.2M	transparent
5115.Q.TR.TX4.4	transparent
5115.Q.TR.TX4.16	transparent
5115.Q.TR.TX8.13	transparent
5115.Q.TR.TX8.28	transparent
5115.Q.TR.TX11.14	transparent
5115.Q.TR.TX23.23	transparent
5115.Q.TR.TXM.16	transparent
5115.Q.TR.TXRK.28	transparent

built-up

5116.P/.. - MANON P TRANSPARANT

~230V IP20 2 m 0,5 m 05.20.02 CE



pendant - round - with 2m textile cable and strain relief on lampholder's side  
 Pendelleuchte - rund - mit 2m Textilkabel und Zugentlastung an Fassung

**Lamp type**  
 1x IT-32 E27 max. 8W **A** 230V

**Dimensions**  
 Ø130xH320 - Cable 2000

**Materials**  
 glass TR

Ref	
5116.P.TR.TX1.1M	transparent
5116.P.TR.TX2.2M	transparent
5116.P.TR.TX3.2M	transparent
5116.P.TR.TX4.4	transparent
5116.P.TR.TX4.16	transparent
5116.P.TR.TX8.13	transparent
5116.P.TR.TX8.28	transparent
5116.P.TR.TX11.14	transparent
5116.P.TR.TX23.23	transparent
5116.P.TR.TXM.16	transparent
5116.P.TR.TXRK.28	transparent

built-up

5120.N/.. - MANON N BRONZ

~230V IP20 2 m 1,7800 0,5 m 05.20.02 CE



pendant - round - with 2m textile cable and strain relief on lampholder's side  
 Pendelleuchte - rund - mit 2m Textilkabel und Zugentlastung an Fassung

**Lamptype**  
 1x G80 E27 max. 40W A - E 230V

**Dimensions**  
 Ø180xH180 - Cable 2000

**Materials**  
 glass BZ

Ref	
5120.N.BZ.TX1.1M	bronze
5120.N.BZ.TX2.2M	bronze
5120.N.BZ.TX3.2M	bronze
5120.N.BZ.TX4.4	bronze
5120.N.BZ.TX4.16	bronze
5120.N.BZ.TX8.13	bronze
5120.N.BZ.TX8.28	bronze
5120.N.BZ.TX11.14	bronze
5120.N.BZ.TX23.23	bronze
5120.N.BZ.TXM.16	bronze
5120.N.BZ.TXRK.28	bronze

built-up

5121.Q/.. - MANON Q BRONZ

~230V IP20 2 m 1,8400 0,5 m 05.20.02 CE



pendant - round - with 2m textile cable and strain relief on lampholder's side  
 Pendelleuchte - rund - mit 2m Textilkabel und Zugentlastung an Fassung

**Lamptype**  
 1x G80 E27 max. 40W A - E 230V

**Dimensions**  
 Ø320xH130 - Cable 2000

**Materials**  
 glass BZ

Ref	
5121.Q.BZ.TX1.1M	bronze
5121.Q.BZ.TX2.2M	bronze
5121.Q.BZ.TX3.2M	bronze
5121.Q.BZ.TX4.4	bronze
5121.Q.BZ.TX4.16	bronze
5121.Q.BZ.TX8.13	bronze
5121.Q.BZ.TX8.28	bronze
5121.Q.BZ.TX11.14	bronze
5121.Q.BZ.TX23.23	bronze
5121.Q.BZ.TXM.16	bronze
5121.Q.BZ.TXRK.28	bronze

built-up

5122.P/.. - MANON P BRONZ

~230V IP20 2 m 2,2000 0,5 m 05.20.02 CE



pendant - round - with 2m textile cable and strain relief on lampholder's side  
 Pendelleuchte - rund - mit 2m Textilkabel und Zugentlastung an Fassung

**Lamptype**  
 1x IT-32 E27 max. 8W A 230V

**Dimensions**  
 Ø130xH320 - Cable 2000

**Materials**  
 glass BZ

Ref	
5122.PBZ.TX1.1M	bronze
5122.PBZ.TX2.2M	bronze
5122.PBZ.TX3.2M	bronze
5122.PBZ.TX4.4	bronze
5122.PBZ.TX4.16	bronze
5122.PBZ.TX8.13	bronze
5122.PBZ.TX8.28	bronze
5122.PBZ.TX11.14	bronze
5122.PBZ.TX23.23	bronze
5122.PBZ.TXM.16	bronze
5122.PBZ.TXRK.28	bronze

built-up

5123.N/.. - MANON N STEEL

~230V IP20 2 m 0,5 m 05.20.02 CE



pendant - round - with 2m textile cable and strain relief on lampholder's side  
 Pendelleuchte - rund - mit 2m Textilkabel und Zugentlastung an Fassung

Lamp type

1x G80 E27 max. 40W **A** - **E** 230V

Dimensions

Ø180xH180 - Cable 2000

Materials

glass ST

Ref

5123.N.ST.TX1.1M	steel
5123.N.ST.TX2.2M	steel
5123.N.ST.TX3.2M	steel
5123.N.ST.TX4.4	steel
5123.N.ST.TX4.16	steel
5123.N.ST.TX8.13	steel
5123.N.ST.TX8.28	steel
5123.N.ST.TX11.14	steel
5123.N.ST.TX23.23	steel
5123.N.ST.TXM.16	steel
5123.N.ST.TXRK.28	steel

built-up

5124.Q/.. - MANON Q STEEL

~230V IP20 2 m 0,5 m 05.20.02 CE



pendant - round - with 2m textile cable and strain relief on lampholder's side  
 Pendelleuchte - rund - mit 2m Textilkabel und Zugentlastung an Fassung

Lamp type

1x G80 E27 max. 40W **A** - **E** 230V

Dimensions

Ø320xH130 - Cable 2000

Materials

glass ST

Ref

5124.Q.ST.TX1.1M	steel
5124.Q.ST.TX2.2M	steel
5124.Q.ST.TX3.2M	steel
5124.Q.ST.TX4.4	steel
5124.Q.ST.TX4.16	steel
5124.Q.ST.TX8.13	steel
5124.Q.ST.TX8.28	steel
5124.Q.ST.TX11.14	steel
5124.Q.ST.TX23.23	steel
5124.Q.ST.TXM.16	steel
5124.Q.ST.TXRK.28	steel

built-up

5125.P/.. - MANON P STEEL

~230V IP20 2 m 0,5 m 05.20.02 CE



pendant - round - with 2m textile cable and strain relief on lampholder's side  
 Pendelleuchte - rund - mit 2m Textilkabel und Zugentlastung an Fassung

Lamp type

1x IT-32 E27 max. 8W **A** 230V

Dimensions

Ø130xH320 - Cable 2000

Materials

glass ST

Ref

5125.P.ST.TX1.1M	steel
5125.P.ST.TX2.2M	steel
5125.P.ST.TX3.2M	steel
5125.P.ST.TX4.4	steel
5125.P.ST.TX4.16	steel
5125.P.ST.TX8.13	steel
5125.P.ST.TX8.28	steel
5125.P.ST.TX11.14	steel
5125.P.ST.TX23.23	steel
5125.P.ST.TXM.16	steel
5125.P.ST.TXRK.28	steel

built-up

5130.3N/.. - MANON N COMBI

~230V IP20 1,5 m 0,5 m 05.20.02 CE



pendant - with 3x 1,5m textile cable on Juba base  
 Pendelleuchte - mit 3x 1,5m Textilkabel auf Basis Juba

Lamp type

3x G80 E27 max. 40W **A** - **E** 230V  
 or 3x A60 E27 max. 10,5W **A** - **E** 230V

Dimensions

L900xB180xH1756,5 - Cable 1500  
 Base - L900xB50xH40  
 Glass - Ø180xH180

Materials

aluminium 1M | 2M

Ref

5130.3N.1M.BZ.TX1	white tex
5130.3N.1M.TR.TX1	white tex
5130.3N.1M.ST.TX1	white tex
5130.3N.2M.BZ.TX2	black tex
5130.3N.2M.TR.TX2	black tex
5130.3N.2M.ST.TX2	black tex
5130.3N.216.TR.TX2	black - gold
5130.3N.216.ST.TX2	black - gold
5130.3N.216.BR.TX2	black - gold

built-up

5131.3Q/.. - MANON Q COMBI

~230V IP20 1,5 m 0,5 m 05.20.02 CE



pendant - with 3x 1,5m textile cable on Juba base  
 Pendelleuchte - mit 3x 1,5m Textilkabel auf Basis Juba

Lamp type

3x G80 E27 max. 40W **A** - **E** 230V  
 or 3x A60 E27 max. 10,5W **A** - **E** 230V

Dimensions

L1200xB320xH1706,5 - Cable 1500  
 Base - L1200xB50xH40  
 Glass - Ø320xH130

Materials

aluminium 1M | 2M

Ref

5131.3Q.1M.BZ.TX1	white tex
5131.3Q.1M.TR.TX1	white tex
5131.3Q.1M.ST.TX1	white tex
5131.3Q.2M.BZ.TX2	black tex
5131.3Q.2M.TR.TX2	black tex
5131.3Q.2M.ST.TX2	black tex
5131.3Q.216.BZ.TX2	black - gold
5131.3Q.216.TR.TX2	black - gold
5131.3Q.216.ST.TX2	black - gold

built-up

5132.3P/.. - MANON P COMBI

~230V IP20 1,5 m 0,5 m 05.20.02 CE



pendant - with 3x 1,5m textile cable on Juba base  
 Pendelleuchte - mit 3x 1,5m Textilkabel auf Basis Juba

Lamp type

3x IT-32 E27 max. 8W **A** 230V

Dimensions

L900xB130xH1896,5 - Cable 1500  
 Base - L900xB50xH40  
 Glass - Ø130xH320

Materials

aluminium 1M | 2M

Ref

5132.3P.1M.BZ.TX1	white tex
5132.3P.1M.TR.TX1	white tex
5132.3P.1M.ST.TX1	white tex
5132.3P.2M.BZ.TX2	black tex
5132.3P.2M.TR.TX2	black tex
5132.3P.2M.ST.TX2	black tex
5132.3P.216.BZ.TX2	black - gold
5132.3P.216.TR.TX2	black - gold
5132.3P.216.ST.TX2	black - gold

built-up



5130.5N/.. - MANON N COMBI

~230V IP20 1,5 m 0,5 m 05.20.02 CE



pendant - with 5x 1,5m textile cable on base Juba  
Pendelleuchte - mit 5x 1,5m Textilkabel auf Basis Juba

Lamp type

5x G80 E27 max. 40W **A** - **E** 230V  
or 5x A60 E27 max. 10,5W **A** - **E** 230V

Dimensions

L1400xB180xH1756,5 - Cable 1500  
Base - L1400xB50xH40  
Glass - Ø180xH180

Materials

aluminium 1M | 2M

Ref

5130.5N.1M.BZ.TX1 white tex  
5130.5N.1M.TR.TX1 white tex  
5130.5N.1M.ST.TX1 white tex  
5130.5N.2M.BZ.TX2 black tex  
5130.5N.2M.TR.TX2 black tex  
5130.5N.2M.ST.TX2 black tex  
5130.5N.216.BZ.TX2 black - gold  
5130.5N.216.TR.TX2 black - gold  
5130.5N.216.ST.TX2 black - gold

built-up

5132.5P/.. - MANON P COMBI

~230V IP20 1,5 m 0,5 m 05.20.02 CE

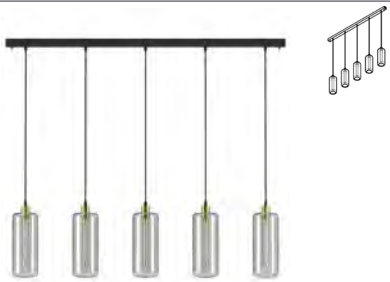

pendant - with 5x 1,5m textile cable on base Juba  
Pendelleuchte - mit 5x 1,5m Textilkabel auf Basis Juba

Lamp type

5x IT-32 E27 max. 8W **A** 230V

Dimensions

L1400xB130xH1896,5 - Cable 1500  
Base - L1400xB50xH40  
Glass - Ø130xH320

Materials

aluminium 1M | 2M

Ref cat (LONG)

5132.5P.1M.BZ.TX1 white tex  
5132.5P.1M.TR.TX1 white tex  
5132.5P.1M.ST.TX1 white tex  
5132.5P.2M.BZ.TX2 black tex  
5132.5P.2M.TR.TX2 black tex  
5132.5P.2M.ST.TX2 black tex  
5132.5P.216.BZ.TX2 black - gold  
5132.5P.216.TR.TX2 black - gold  
5132.5P.216.ST.TX2 black - gold

built-up

5133.3N2P/.. - MANON NP COMBI

~230V IP20 1,5 m 0,5 m 05.20.02 CE



pendant - with 5x 1,5m textile cable on base Juba  
Pendelleuchte - mit 5x 1,5m Textilkabel auf Basis Juba

Lamp type

3x G80 E27 max. 40W **A** - **E** 230V  
2x IT-32 E27 max. 8W **A** 230V

Dimensions

L1400xB180xH1896,5 - Cable 1500  
Base - L1400xB50xH40  
Glass - Ø180xH180  
Glass - Ø130xH320

Materials

aluminium 1M | 2M

Ref

5133.3N2P.1M.BZ.TX1 white tex  
5133.3N2P.1M.TR.TX1 white tex  
5133.3N2P.1M.ST.TX1 white tex  
5133.3N2P.2M.BZ.TX2 black tex  
5133.3N2P.2M.TR.TX2 black tex  
5133.3N2P.2M.ST.TX2 black tex  
5133.3N2P.216.BZ.TX2 black - gold  
5133.3N2P.216.TR.TX2 black - gold  
5133.3N2P.216.ST.TX2 black - gold

built-up



5134.2N3Q/.. - MANON NQ COMBI

~230V IP20 1,5 m 0,5 m 05.20.02 CE



pendant - with 5x 1,5m textile cable on base Juba  
Pendelleuchte - mit 5x 1,5m Textilkabel auf Basis Juba

Lamp type

5x G80 E27 max. 40W **A** - **E** 230V  
or 5x A60 E27 max. 10,5W **A** - **E** 230V

Dimensions

L1400xB320xH1706,5 - Cable 1500

Base - L1400xB50xH40

Glass - Ø320xH130

Glass - Ø180xH180

Materials

aluminium 1M | 2M

Ref

5134.2N3Q.1M.BZ.TX1 white tex  
5134.2N3Q.1M.TR.TX1 white tex  
5134.2N3Q.1M.ST.TX1 white tex  
5134.2N3Q.2M.BZ.TX2 black tex  
5134.2N3Q.2M.TR.TX2 black tex  
5134.2N3Q.2M.ST.TX2 black tex  
5134.2N3Q.216.BZ.TX2 black - gold  
5134.2N3Q.216.TR.TX2 black - gold  
5134.2N3Q.216.ST.TX2 black - gold

built-up

5135.1N2Q2P/.. - MANON NQP COMBI

~230V IP20 1,5 m 0,5 m 05.20.02 CE



pendant - with 5x 1,5m textile cable on base Juba  
Pendelleuchte - mit 5x 1,5m Textilkabel auf Basis Juba

Lamp type

3x G80 E27 max. 40W **A** - **E** 230V  
2x IT-32 E27 max. 8W **A** 230V

Dimensions

L1400xB320xH1706,5 - Cable 1500

Base - L1400xB50xH40

Glass - Ø130xH320

Glass - Ø180xH180

Glass - Ø320xH130

Materials

aluminium 1M | 2M

Ref

5135.1N2Q2P.1M.BZ.TX1 white tex  
5135.1N2Q2P.1M.TR.TX1 white tex  
5135.1N2Q2P.1M.ST.TX1 white tex  
5135.1N2Q2P.2M.BZ.TX2 black tex  
5135.1N2Q2P.2M.TR.TX2 black tex  
5135.1N2Q2P.2M.ST.TX2 black tex  
5135.1N2Q2P.216.BZ.TX2 black - gold  
5135.1N2Q2P.216.TR.TX2 black - gold  
5135.1N2Q2P.216.ST.TX2 black - gold

built-up

5143.1N1Q1P/.. - MANON NQP COMBI

~230V IP20 1,5 m 0,5 m 05.20.02 CE



pendant - with 3x 1,5m textile cable on base Rondo Box  
Pendelleuchte - mit 3x 1,5m Textilkabel auf Basis Rondo Box

Lamp type

2x G80 E27 max. 40W **A** - **E** 230V  
1x IT-32 E27 max. 8W **A** 230V

Dimensions

Ø519xH1756 - Cable 1500

Base - Ø400xH28

Glass - Ø130xH320

Glass - Ø320xH130

Glass - Ø180xH180

Materials

aluminium 1M | 2M

Ref cat (LONG)

5143.1N1Q1P.1M.BZ.TX1 white tex  
5143.1N1Q1P.1M.TR.TX1 white tex  
5143.1N1Q1P.1M.ST.TX1 white tex  
5143.1N1Q1P.2M.BZ.TX2 black tex  
5143.1N1Q1P.2M.TR.TX2 black tex  
5143.1N1Q1P.2M.ST.TX2 black tex  
5143.1N1Q1P.216.BZ.TX2 black - gold  
5143.1N1Q1P.216.TR.TX2 black - gold  
5143.1N1Q1P.216.ST.TX2 black - gold

built-up



4057/.. - MONA - B3

~230V



0,8 m



1,2600



0,5 m



pendant with swivel - opal matt  
Pendelleuchte mit Kugelgelenk - Opal matt

**Lamp type**

1x A60 E27 max. 52W A E 230V

**Dimensions**

Ø150xH240 - Bar 800

**Materials**

aluminium 14 | 1M | 2M

**Ref**

4057.1M

4057.2M

4057.14

white tex

black tex

alu satin

built-up

PENDANTS





4051/.. - MONA LISA Ø120 - B3

~230V IP20       0,8 m  0,5 m  



pendant with swivel - black mat outside - papyrus leaf gold inside  
 Pendelleuchte mit Kugelgelenk - matt Schwarz an der Aussenseite - papyrus Blattgold an der Innenseite

Ref	
4051.1M	white tex
4051.2M	black tex
4051.14	alu satin

**Lamp type**  
 1x QT14 G9 max. 20W  230V

**Dimensions**  
 Ø120xH70 - Bar 800  
 Bar - Ø8,3

**Options**  
 033 - ROZET VOOR PENDEL  
 065.D8,3 - ROSETTE

**Materials**  
 aluminium 14 | 1M | 2M

*built-up*  
 rod + glass 5098 included  
 Stange + Glas 5098 einbegriffen

4052/.. - MONA LISA Ø120 - B3

~230V IP20       0,8 m  0,5 m  



pendant with swivel - matt white outside - papyrus leaf gold inside  
 Pendelleuchte mit Kugelgelenk - matt Weiß an der Aussenseite - papyrus Blattgold an der Innenseite

Ref	
4052.1M	white tex
4052.2M	black tex
4052.14	alu satin

**Lamp type**  
 1x QT14 G9 max. 20W  230V

**Dimensions**  
 Ø120xH70 - Bar 800  
 Bar - Ø8,3

**Options**  
 033 - ROZET VOOR PENDEL  
 065.D8,3 - ROSETTE

**Materials**  
 aluminium 14 | 1M | 2M

*built-up*  
 rod + glass 5098W included  
 Stange + Glas 5098W einbegriffen

4053/.. - MONA LISA Ø180 - B3

~230V IP20       0,8 m  0,8200  0,5 m  

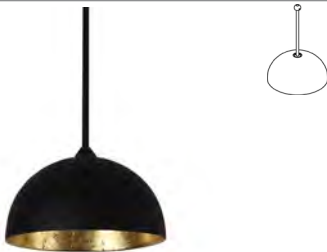

pendant with swivel - black mat outside - papyrus leaf gold inside  
 Pendelleuchte mit Kugelgelenk - matt Schwarz an der Aussenseite - papyrus Blattgold an der Innenseite

Ref	
4053.1M	white tex
4053.2M	black tex
4053.14	alu satin

**Lamp type**  
 1x QT14 G9 max. 25W  230V

**Dimensions**  
 Ø180xH95 - Bar 800  
 Bar - Ø8,3

**Options**  
 033 - ROZET VOOR PENDEL  
 065.D8,3 - ROSETTE

**Materials**  
 aluminium 14 | 1M | 2M

*built-up*  
 rod + glass 5044 included  
 Stange + Glas 5044 einbegriffen

4056/.. - MONA LISA Ø300 - B3

~230V IP20       0,8 m  2,1000  0,5 m  



pendant with swivel - black mat outside - papyrus leaf gold inside  
 Pendelleuchte mit Kugelgelenk - matt Schwarz an der Aussenseite - papyrus Blattgold an der Innenseite

Ref	
4056.1M	white tex
4056.2M	black tex
4056.14	alu satin

**Lamp type**  
 1x A60 E27 max. 40W  230V

**Dimensions**  
 Ø300xH150 - Bar 800  
 Bar - Ø12

**Options**  
 037.D12 - ROSETTE

**Materials**  
 aluminium 14 | 1M | 2M

*built-up*  
 rod + glass 362 included  
 Stange + Glas 362 einbegriffen



4055/.. - MONA LISA Ø450 - B3

~230V  IP20    0,8 m  3,8700  0,5 m  05.20.02 



pendant with swivel - black mat outside - papyrus leaf gold inside  
 Pendelleuchte mit Kugelgelenk - matt Schwarz an der Aussenseite - papyrus Blattgold an der Innenseite

Ref	
4055.1M	white tex
4055.2M	black tex
4055.14	alu satin

**Lamp type**  
 1x A60 E27 max. 40W  230V

**Dimensions**  
 Ø450xH150 - Bar 800  
 Bar - Ø12

**Options**  
 037.D12 - ROSETTE

**Materials**  
 aluminium 14 | 1M | 2M

*built-up*  
 rod + glass 0434 included  
 Stange + Glas 0434 einbegriffen

PENDANTS

4054/.. - MONA LISA Ø550 - B3

~230V  IP20    0,8 m  6,0500  0,5 m  05.20.02 



pendant with swivel - black mat outside - papyrus leaf gold inside  
 Pendelleuchte mit Kugelgelenk - matt Schwarz an der Aussenseite - papyrus Blattgold an der Innenseite

Ref	
4054.1M	white tex
4054.2M	black tex
4054.14	alu satin

**Lamp type**  
 1x A60 E27 max. 40W  230V

**Dimensions**  
 Ø550xH200 - Bar 800  
 Bar - Ø12

**Options**  
 037.D12 - ROSETTE

**Materials**  
 aluminium 14 | 1M | 2M

*built-up*  
 rod + glass 0465 included  
 Stange + Glas 0465 einbegriffen



5063.C.E27.SH/.. - MOBY SH TRANSPARANT - TX

~230V IP20 2 m 0,5 m 05.20.02 CE



pendant - with 2m textile cable and strain relief on lampholder's side  
 Pendelleuchte - mit 2m Textilkabel und Zugentlastung an Fassung

**Lamp type**

1x G80 E27 max. 40W **A** - **E** 230V

**Dimensions**

Ø245xH210 - Cable 2000

**Materials**

glass TR

**Ref**

5063.C.E27.SH.TR.TX1.1M	transparent
5063.C.E27.SH.TR.TX2.2M	transparent
5063.C.E27.SH.TR.TX11.14	transparent
5063.C.E27.SH.TR.TXG23.23	transparent
5063.C.E27.SH.TR.TXM.16	transparent
5063.C.E27.SH.TR.TXRX.28	transparent

built-up

5064.B.E27.SH/.. - MOBY SH TRANSPARANT - TX

~230V IP20 2 m 0,5 m 05.20.02 CE



pendant - with 2m textile cable and strain relief on lampholder's side  
 Pendelleuchte - mit 2m Textilkabel und Zugentlastung an Fassung

**Lamp type**

1x A60 E27 max. 10,5W **A** - **E** 230V

**Dimensions**

Ø180xH140 - Cable 2000

**Materials**

glass TR

**Ref**

5064.B.E27.SH.TR.TX1.1M	transparent
5064.B.E27.SH.TR.TX2.2M	transparent
5064.B.E27.SH.TR.TX11.14	transparent
5064.B.E27.SH.TR.TXG23.23	transparent
5064.B.E27.SH.TR.TXM.16	transparent
5064.B.E27.SH.TR.TXRX.28	transparent

built-up

5082.A.E27.SH/.. - MOBY SH TRANSPARANT - TX

~230V IP20 2 m 0,5 m 05.20.02 CE



pendant - with 2m textile cable and strain relief on lampholder's side  
 Pendelleuchte - mit 2m Textilkabel und Zugentlastung an Fassung

**Lamp type**

1x D45 E27 max. 5W **A** - **E** 230V

**Dimensions**

Ø140xH120 - Cable 2000

**Materials**

glass TR

**Ref**

5082.A.E27.SH.TR.TX1.1M	transparent
5082.A.E27.SH.TR.TX2.2M	transparent
5082.A.E27.SH.TR.TX11.14	transparent
5082.A.E27.SH.TR.TXG23.23	transparent
5082.A.E27.SH.TR.TXM.16	transparent
5082.A.E27.SH.TR.TXRX.28	transparent

built-up





5068.C.E27.SH/.. - MOBY SH SMOKEY GREY - TX

~230V IP20 2m 0,5 m 05.20.02 CE



pendant - with 2m textile cable and strain relief on lampholder's side  
 Pendelleuchte - mit 2m Textilkabel und Zugentlastung an Fassung

**Ref**  
 5068.C.E27.SH.SG.TX2.2M smokey grey  
 5068.C.E27.SH.SG.TX44.44 smokey grey

**Lamptype**  
 1x G80 E27 max. 40W A - E 230V

**Dimensions**  
 Ø245xH210 - 2000

**Materials**  
 glass SG

built-up

transparent glass

5069.B.E27.SH/.. - MOBY SH SMOKEY GREY - TX

~230V IP20 0,5 m 05.20.02 CE



pendant - with 2m textile cable and strain relief on lampholder's side  
 Pendelleuchte - mit 2m Textilkabel und Zugentlastung an Fassung

**Ref**  
 5069.B.E27.SH.SG.TX2.2M smokey grey  
 5069.B.E27.SH.SG.TX44.44 smokey grey

**Lamptype**  
 1x A60 E27 max. 10,5W A - E 230V

**Dimensions**  
 Ø180xH140 - 2000

**Materials**  
 glass SG

built-up

transparent glass

5083.A.E27.SH/.. - MOBY SH SMOKEY GREY - TX

~230V IP20 0,5 m 05.20.02 CE



pendant - with 2m textile cable and strain relief on lampholder's side  
 Pendelleuchte - mit 2m Textilkabel und Zugentlastung an Fassung

**Ref**  
 5083.A.E27.SH.SG.TX2.2M smokey grey  
 5083.A.E27.SH.SG.TX44.44 smokey grey

**Lamptype**  
 1x D45 E27 max. 15W A - E 230V

**Dimensions**  
 Ø140xH120 - 2000

**Materials**  
 glass SG

built-up

transparent glass



5128.C.E27.SH/.. - MOBY SH STEEL - TX

~230V



IP20



2 m

0.5 m

05.20.02



pendant - with 2m textile cable and strain relief on lampholder's side  
 Pendelleuchte - mit 2m Textilkabel und Zugentlastung an Fassung

**Ref**

5128.C.E27.SH.ST.TX2.2M

steel

5128.C.E27.SH.ST.TX44.44

steel

**Lamp type**

1x G80 E27 max. 40W A - E 230V

**Dimensions**

Ø245xH210 - 2000

**Materials**

glass ST

*built-up*

*transparent glass*

PENDANTS



5078.C.E27.SH/.. - MOBY SH BRONZ - TX

~230V IP20 2 m 1,3900 0,5 m 05.20.02 CE



pendant - with 2m textile cable and strain relief on lampholder's side  
 Pendelleuchte - mit 2m Textilkabel und Zugentlastung an Fassung

**Lamp type**

1x G80 E27 max. 40W A - E **230V**

**Dimensions**

Ø245xH210 - 2000

**Materials**

glass **BZ**

**Ref**

5078.C.E27.SH.BZ.TX2.13	bronze
5078.C.E27.SH.BZ.TX2.2M	bronze
5078.C.E27.SH.BZ.TX7.44	bronze
5078.C.E27.SH.BZ.TX12.53	bronze
5078.C.E27.SH.BZ.TXG4.53	bronze
5078.C.E27.SH.BZ.TXG13.Z53	bronze
5078.C.E27.SH.BZ.TXJ.2M	bronze
5078.C.E27.SH.BZ.TXJ.53	bronze

built-up

transparent glass

5079.B.E27.SH/.. - MOBY SH BRONZ - TX

~230V IP20 2 m 0,9400 0,5 m 05.20.02 CE



pendant - with 2m textile cable and strain relief on lampholder's side  
 Pendelleuchte - mit 2m Textilkabel und Zugentlastung an Fassung

**Lamp type**

1x G80 E27 max. 40W A - E **230V**

**Dimensions**

Ø180xH210 - 2000

**Materials**

glass **BZ**

**Ref**

5079.B.E27.SH.BZ.TX2.13	bronze
5079.B.E27.SH.BZ.TX2.2M	bronze
5079.B.E27.SH.BZ.TX7.44	bronze
5079.B.E27.SH.BZ.TX12.53	bronze
5079.B.E27.SH.BZ.TX44	bronze
5079.B.E27.SH.BZ.TXG4.53	bronze
5079.B.E27.SH.BZ.TXG13.Z53	bronze
5079.B.E27.SH.BZ.TXJ.13	bronze
5079.B.E27.SH.BZ.TXJ.53	bronze

built-up

transparent glass

5126.A.E27.SH/.. - MOBY SH BRONZ - TX

~230V IP20 2 m 0,6500 0,5 m 05.20.02 CE



suspension with textile cable - with 2m textile cable and strain relief on lampholder's side  
 pendelleuchte mit Textilkabel - mit 2m Textilkabel und Zugentlastung an Fassung

**Lamp type**

1x D45 E27 max. 5W A - E **230V**

**Dimensions**

Ø140xH120 - 2000

**Materials**

glass **BZ**

**Ref**

5126.A.E27.SH.BZ.TX1.1M	bronze
5126.A.E27.SH.BZ.TX2.13	bronze
5126.A.E27.SH.BZ.TX2.2M	bronze
5126.A.E27.SH.BZ.TX7.44	bronze
5126.A.E27.SH.BZ.TX12.53	bronze
5126.A.E27.SH.BZ.TXG4.46	bronze
5126.A.E27.SH.BZ.TXJ.53	bronze

built-up

transparent glass

4995.A.E27.SH/.. - MOBY GOLD - TX

~230V IP20 2 m 0,5 m 05.20.02 CE



suspension - with 2m textile cable and strain relief on lampholder's side  
pendelleucht - mit 2m Textilkabel und Zugentlastung an Fassung

**Ref**  
4995.A.E27.SH.GC.TX2.2M gold coat  
4995.A.E27.SH.GC.TX4.4 gold coat  
4995.A.E27.SH.GC.TXM.4 gold coat

**Lamp type**  
1x D45 E27 max. 15W **A** - **E** 230V

**Dimensions**  
Ø140xH120 - 2000

**Materials**  
glass GC

*built-up*

*gold coated glass*

4996.A.E27.SH/.. - MOBY RKC - TX

~230V IP20 2 m 0,5 m 05.20.02 CE



suspension - with 2m textile cable and strain relief on lampholder's side  
pendelleuchte - mit 2m Textilkabel und Zugentlastung an Fassung

**Ref**  
4996.A.E27.SH.RKC.TX2.2M red copper coat  
4996.A.E27.SH.RKC.TXG28.28 red copper coat  
4996.A.E27.SH.RKC.TXRK.28 red copper coat

**Lamp type**  
1x D45 E27 max. 15W **A** - **E** 230V

**Dimensions**  
Ø140xH120 - 2000

**Materials**  
glass RKC

*built-up*

*red copper coated glass*

4997.A.E27.SH/.. - MOBY SH PINKY - TX

~230V IP20 2 m 0,5 m 05.20.02 CE



suspension - with 2m textile cable and strain relief on lampholder's side  
pendelleuchte - mit 2m Textilkabel und Zugentlastung an Fassung

**Ref**  
4997.A.E27.SH.PKY.TX2.2M pinky  
4997.A.E27.SH.PKY.TX31.46 pinky  
4997.A.E27.SH.PKY.TXG30.46 pinky

**Lamp type**  
1x D45 E27 max. 15W **A** - **E** 230V

**Dimensions**  
Ø140xH120 - 2000

*built-up*

*pink coated glass*





5087.C.E27/.. - MOBY TRANSPARANT - TX

~230V IP20 2 m 1,7000 0,5 m 05.20.02 CE



pendant - with 2m textile cable and strain relief on lampholder's side  
 Pendelleuchte - mit 2m Textilkabel und Zugentlastung an Fassung

**Lamp type**

1x G80 E27 max. 40W **A** - **E** 230V

**Dimensions**

Ø245xH210 - Cable 2000

**Options**

000C - TREKONTLASTING PER PENDEL TEXTILE  
 000CR - TREKONTLASTING PER PENDEL TEXTILE

**Materials**

glass TR

**Ref**

5087.C.E27.TR.TX1.1M transparent  
 5087.C.E27.TR.TX2.2M transparent  
 5087.C.E27.TR.TX11.14 transparent  
 5087.C.E27.TR.TXG23.23 transparent  
 5087.C.E27.TR.TXM.16 transparent  
 5087.C.E27.TR.TXRK.28 transparent

built-up

5088.B.E27/.. - MOBY TRANSPARANT - TX

~230V IP20 2 m 0,9600 0,5 m 05.20.02 CE



pendant - with 2m textile cable and strain relief on lampholder's side  
 Pendelleuchte - mit 2m Textilkabel und Zugentlastung an Fassung

**Lamp type**

1x A60 E27 max. 10,5W **A** - **E** 230V

**Dimensions**

Ø180xH140 - Cable 2000

**Options**

000C - TREKONTLASTING PER PENDEL TEXTILE  
 000CR - TREKONTLASTING PER PENDEL TEXTILE

**Materials**

glass TR

**Ref**

5088.B.E27.TR.TX1.1M transparent  
 5088.B.E27.TR.TX2.2M transparent  
 5088.B.E27.TR.TX11.14 transparent  
 5088.B.E27.TR.TXG23.23 transparent  
 5088.B.E27.TR.TXM.16 transparent  
 5088.B.E27.TR.TXRK.28 transparent

built-up

5089.A.E27/.. - MOBY TRANSPARANT - TX

~230V IP20 2 m 0,5 m 05.20.02 CE



pendant - with 2m textile cable and strain relief on lampholder's side  
 Pendelleuchte - mit 2m Textilkabel und Zugentlastung an Fassung

**Lamp type**

1x D45 E27 max. 5W **A** - **E** 230V

**Dimensions**

Ø140xH120 - Cable 2000

**Options**

000C - TREKONTLASTING PER PENDEL TEXTILE  
 000CR - TREKONTLASTING PER PENDEL TEXTILE

**Materials**

glass TR

**Ref**

5089.A.E27.TR.TX1.1M transparent  
 5089.A.E27.TR.TX2.2M transparent  
 5089.A.E27.TR.TX11.14 transparent  
 5089.A.E27.TR.TXG23.23 transparent  
 5089.A.E27.TR.TXM.16 transparent  
 5089.A.E27.TR.TXRK.28 transparent

built-up

5089.A.E14/.. - MOBY TRANSPARANT - TX

~230V  IP20      2 m  0,6000  0,5 m  05.20.02 



pendant - with 2m textile cable and strain relief on lampholder's side  
 Pendelleuchte - mit 2m Textilkabel und Zugentlastung an Fassung

**Lamptype**  
 ◀ 1x D45 E40 max. 40W  -  ▶ 230V

**Dimensions**  
 ⇄ Ø140xH120 - Cable 2000

**Options**  
 000C - TREKONTLASTING PER PENDEL TEXTILE  
 000CR - TREKONTLASTING PER PENDEL TEXTILE

**Materials**  
 glass TR

**Ref**  
 5089.A.E14.TR.TX1.1M transparent  
 5089.A.E14.TR.TX2.2M transparent  
 5089.A.E14.TR.TX11.14 transparent  
 5089.A.E14.TR.TXG23.23 transparent  
 5089.A.E14.TR.TXM.16 transparent  
 5089.A.E14.TR.TXRK.28 transparent

built-up

5089.A.G9/.. - MOBY TRANSPARANT - TX

~230V  IP20      2 m  0,5 m  05.20.02 



pendant - with 2m textile cable and strain relief on lampholder's side  
 Pendelleuchte - mit 2m Textilkabel und Zugentlastung an Fassung

**Lamptype**  
 ⇄ 1x QT14 G9 max. 7W  -  ▶ 230V

**Dimensions**  
 ⇄ Ø140xH120 - Cable 2000

**Options**  
 000C - TREKONTLASTING PER PENDEL TEXTILE  
 000CR - TREKONTLASTING PER PENDEL TEXTILE

**Materials**  
 glass TR

**Ref**  
 5089.A.G9.TR.TX1.1M transparent  
 5089.A.G9.TR.TX2.2M transparent  
 5089.A.G9.TR.TX11.14 transparent  
 5089.A.G9.TR.TXG23.23 transparent  
 5089.A.G9.TR.TXM.16 transparent  
 5089.A.G9.TR.TXRK.28 transparent

built-up

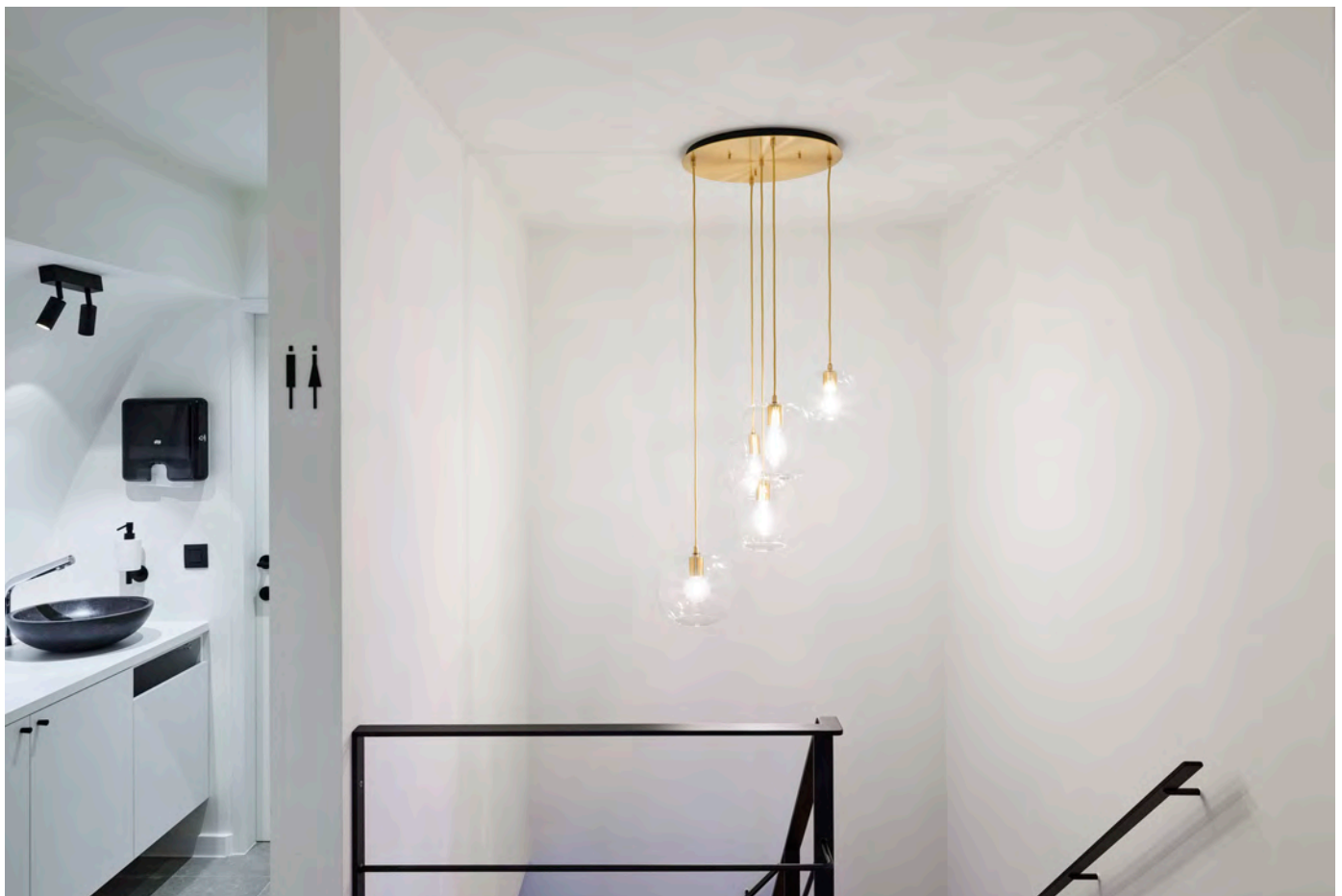

5043.E.E27/.. - MOBY STEEL - TX

~230V IP20 2m 1,1300 0,5 m 05.20.02 CE



pendant - with 2m textile cable and strain relief on lampholder's side  
 Pendelleuchte - mit 2m Textilkabel und Zugentlastung an Fassung

**Lamptype**

1x G80 E27 max. 40W A - E 230V

**Dimensions**

Ø200xH210 - cable 2000

**Options**

000C - TREKONTLASTING PER PENDEL TEXTILE  
 000CR - TREKONTLASTING PER PENDEL TEXTILE

**Materials**

glass ST

**Ref**

5043.E.E27.ST.TX1.1M steel  
 5043.E.E27.ST.TX2.2M steel  
 5043.E.E27.ST.TX11.14 steel  
 5043.E.E27.ST.TXG23.23 steel  
 5043.E.E27.ST.TXM.16 steel  
 5043.E.E27.ST.TXRK.28 steel

built-up

transparent glass

5109.C.E27/.. - MOBY STEEL - TX

~230V IP20 2m 0,5 m 05.20.02 CE



pendant - with 2m textile cable and strain relief on lampholder's side  
 Pendelleuchte - mit 2m Textilkabel und Zugentlastung an Fassung

**Lamptype**

1x G80 E27 max. 40W A - E 230V

**Dimensions**

Ø245xH210 - cable 2000

**Materials**

glass ST

**Ref**

5109.C.E27.ST.TX2.2M steel  
 5109.C.E27.ST.TX44.44 steel

built-up

transparent glass



5097.E27/.. - MOBY TRANSPARENT - TX

~230V IP20 2 m 1,2500 0,5 m 05.20.02 CE



pendant - with 2m textile cable and strain relief on lampholder's side  
 Pendelleuchte - mit 2m Textilkabel und Zugentlastung an Fassung

**Lamp type**

1x G80 E27 max. 40W **A** - **E** 230V

**Dimensions**

Ø200xH210 - Cable 2000

**Options**

000C - TREKONTLASTING PER PENDEL TEXTILE  
 000CR - TREKONTLASTING PER PENDEL TEXTILE

**Materials**

glass TR

**Ref**

5097.E27.TR.TX1.1M	transparent
5097.E27.TR.TX2.2M	transparent
5097.E27.TR.TX11.14	transparent
5097.E27.TR.TXG23.23	transparent
5097.E27.TR.TXM.16	transparent
5097.E27.TR.TXRK.28	transparent

built-up

5098.E27/.. - MOBY TRANSPARENT - TX

~230V IP20 2 m 1,0300 0,5 m 05.20.02 CE



pendant - with 2m textile cable and strain relief on lampholder's side  
 Pendelleuchte - mit 2m Textilkabel und Zugentlastung an Fassung

**Lamp type**

1x ST64 E27 max. 40W **A** - **E** 230V

or 1x G80 E27 max. 40W **A** - **E** 230V

**Dimensions**

Ø200xH200 - Cable 2000

**Options**

000C - TREKONTLASTING PER PENDEL TEXTILE  
 000CR - TREKONTLASTING PER PENDEL TEXTILE

**Materials**

glass TR

**Ref**

5098.E27.TR.TX1.1M	transparent
5098.E27.TR.TX2.2M	transparent
5098.E27.TR.TX11.14	transparent
5098.E27.TR.TXG23.23	transparent
5098.E27.TR.TXM.16	transparent
5098.E27.TR.TXRK.28	transparent

built-up



5084.C.E27/.. - MOBY SMOKEY GREY - TX

~230V IP20 1,4300 0,5 m 05.20.02 CE



pendant - with 2m textile cable and strain relief on lampholder's side  
 Pendelleuchte - mit 2m Textilkabel und Zugentlastung an Fassung

**Ref**  
 5084.C.E27.SG.TX2.2M smokey grey  
 5084.C.E27.SG.TX44.44 smokey grey

**Lamptype**  
 1x G80 E27 max. 40W **A** - **E** 230V

**Dimensions**  
 Ø245xH210 - Cable 2000

**Options**  
 000C - TREKONTLASTING PER PENDEL TEXTILE  
 000CR - TREKONTLASTING PER PENDEL TEXTILE

**Materials**  
 glass SG

built-up

transparent glass

5085.B.E27/.. - MOBY SMOKEY GREY - TX

~230V IP20 0,9400 0,5 m 05.20.02 CE



pendant - with 2m textile cable and strain relief on lampholder's side  
 Pendelleuchte - mit 2m Textilkabel und Zugentlastung an Fassung

**Ref**  
 5085.B.E27.SG.TX2.2M smokey grey  
 5085.B.E27.SG.TX44.44 smokey grey

**Lamptype**  
 1x A60 E27 max. 10,5W **A** - **E** 230V

**Dimensions**  
 Ø180xH140 - Cable 2000

**Options**  
 000C - TREKONTLASTING PER PENDEL TEXTILE  
 000CR - TREKONTLASTING PER PENDEL TEXTILE

**Materials**  
 glass SG

built-up

transparent glass

5086.A.E27/.. - MOBY SMOKEY GREY - TX

~230V IP20 0,6600 0,5 m 05.20.02 CE



pendant - with 2m textile cable and strain relief on lampholder's side  
 Pendelleuchte - mit 2m Textilkabel und Zugentlastung an Fassung

**Ref**  
 5086.A.E27.SG.TX2.2M smokey grey  
 5086.A.E27.SG.TX44.44 smokey grey

**Lamptype**  
 1x D45 E27 max. 15W **A** - **E** 230V

**Dimensions**  
 Ø140xH120 - Cable 2000

**Options**  
 000C - TREKONTLASTING PER PENDEL TEXTILE  
 000CR - TREKONTLASTING PER PENDEL TEXTILE

**Materials**  
 glass SG

built-up

transparent glass

5099.A.E14/.. - MOBY SMOKEY GREY - TX

~230V IP20 0,3100 0,5 m 05.20.02 CE



pendant - with 2m textile cable and strain relief on lampholder's side  
 Pendelleuchte - mit 2m Textilkabel und Zugentlastung an Fassung

**Ref**  
 5099.A.E14.SG.TX2.2M smokey grey  
 5099.A.E14.SG.TX44.44 smokey grey

**Lamptype**  
 1x D45 E40 max. 40W **A** - **E** 230V

**Dimensions**  
 Ø140xH120 - 2000

**Materials**  
 glass SG

built-up

transparent glass

5090.G.E27/.. - MOBY GLASS - TX

~230V  IP20      2 m  0,5 m  05.20.02 



pendant - with 2m textile cable and strain relief on lampholder's side  
 Pendelleuchte - mit 2m Textilkabel und Zugentlastung an Fassung

**Ref**  
 5090.G.E27.SG.TX2.2M smokey grey  
 5090.G.E27.SG.TX7.14 smokey grey

**Lamp type**

1x ST64 E27 max. 40W  230V

**Dimensions**

Ø200xH300 - Cable 2000

**Options**

000C - TREKONTLASTING PER PENDEL TEXTILE  
 000CR - TREKONTLASTING PER PENDEL TEXTILE

**Materials**

glass SG

built-up

transparent glass - conical

5092.H.E27/.. - MOBY GLASS - TX

~230V  IP20      2 m  3,1400  0,5 m  05.20.02 



pendant - with 2m textile cable and strain relief on lampholder's side  
 Pendelleuchte

**Ref**  
 5092.H.E27.SG.TX2.2M smokey grey  
 5092.H.E27.SG.TX7.14 smokey grey

**Lamp type**

1x A60 E27 max. 10,5W  230V

**Dimensions**

Ø120xH400 - Cable 2000

**Options**

000C - TREKONTLASTING PER PENDEL TEXTILE  
 000CR - TREKONTLASTING PER PENDEL TEXTILE

**Materials**

glass SG

built-up

transparent glass - cylinder



5093.C.E27/.. - MOBY BRONZ - TX

~230V  IP20      2 m  1,3900  0,5 m  05.20.02 



pendant - with 2m textile cable and strain relief on lampholder's side  
 Pendelleuchte - mit 2m Textilkabel und Zugentlastung an Fassung

**Lamp type**

1x G80 E27 max. 6W  -  **230V**

**Dimensions**

Ø245xH210 - Cable 2000

**Options**

000C - TREKONTLASTING PER PENDEL TEXTILE  
 000CR - TREKONTLASTING PER PENDEL TEXTILE

**Materials**

glass **BZ**

**Ref**

5093.C.E27.BZ.TX2.2M bronze  
 5093.C.E27.BZ.TX7.44 bronze  
 5093.C.E27.BZ.TX12.53 bronze  
 5093.C.E27.BZ.TX33.53 bronze  
 5093.C.E27.BZ.TXG4.53 bronze  
 5093.C.E27.BZ.TXG13.Z53 bronze  
 5093.C.E27.BZ.TXJ.2M bronze  
 5093.C.E27.BZ.TXJ.53 bronze

built-up

transparent glass

5094.B.E27/.. - MOBY BRONZ - TX

~230V  IP20      2 m  0,9900  0,5 m  05.20.02 



pendant - with 2m textile cable and strain relief on lampholder's side  
 Pendelleuchte - mit 2m Textilkabel und Zugentlastung an Fassung

**Lamp type**

1x A60 E27 max. 10,5W  -  **230V**

**Dimensions**

Ø180xH140 - Cable 2000

**Options**

000C - TREKONTLASTING PER PENDEL TEXTILE  
 000CR - TREKONTLASTING PER PENDEL TEXTILE

**Materials**

glass **BZ**

**Ref**

5094.B.E27.BZ.TX2.2M bronze  
 5094.B.E27.BZ.TX7.44 bronze  
 5094.B.E27.BZ.TX12.53 bronze  
 5094.B.E27.BZ.TX44.2M bronze  
 5094.B.E27.BZ.TXG4.53 bronze  
 5094.B.E27.BZ.TXG13.Z53 bronze  
 5094.B.E27.BZ.TXJ.53 bronze

built-up

transparent glass

5095.A.E27/.. - MOBY BRONZ - TX

~230V  IP20      2 m  0,7000  0,5 m  05.20.02 



suspension - with 2m textile cable and strain relief on lampholder's side  
 pendelleuchte - mit 2m Textilkabel und Zugentlastung an Fassung

**Lamp type**

1x D45 E27 max. 5W  -  **230V**

**Dimensions**

Ø140xH120 - Cable 2000

**Options**

000C - TREKONTLASTING PER PENDEL TEXTILE  
 000CR - TREKONTLASTING PER PENDEL TEXTILE

**Materials**

glass **BZ**

**Ref**

5095.A.E27.BZ.TX1.1M bronze  
 5095.A.E27.BZ.TX2.2M bronze  
 5095.A.E27.BZ.TX7.44 bronze  
 5095.A.E27.BZ.TX12.53 bronze  
 5095.A.E27.BZ.TX43.153 bronze  
 5095.A.E27.BZ.TXG4.46 bronze  
 5095.A.E27.BZ.TXJ.53 bronze

built-up

transparent glass

PENDANTS

5095.A.E14/.. - MOBY BRONZ - TX

~230V  IP20      2m  0,8200  0,5 m  05.20.02 



suspension - with 2m textile cable and strain relief on lampholder's side  
pendelleuchte - mit 2m Textilkabel und Zugentlastung an Fassung

**Lamp type**

◀ 1x D45 E40 max. 40W  ▶ 230V

**Dimensions**

↔ Ø140xH120 - Cable 2000

**Options**

000C - TREKONTLASTING PER PENDEL TEXTILE  
000CR - TREKONTLASTING PER PENDEL TEXTILE

**Materials**

glass BZ

**Ref**

5095.A.E14.BZ.TX1.1M bronze  
5095.A.E14.BZ.TX2.2M bronze  
5095.A.E14.BZ.TX7.44 bronze  
5095.A.E14.BZ.TX12.53 bronze  
5095.A.E14.BZ.TXG4.46 bronze  
5095.A.E14.BZ.TXJ.53 bronze

built-up

transparent glass

5095.A.G9/.. - MOBY BRONZ - TX

~230V  IP20      2m  0,5 m  05.20.02 



pendant - with 2m textile cable and strain relief on lampholder's side  
Pendelleuchte - mit 2m Textilkabel und Zugentlastung an Fassung

**Lamp type**

≡ 1x QT14 G9 max. 7W  ▶ 230V

**Dimensions**

↔ Ø140xH120 - Cable 2000

**Options**

000C - TREKONTLASTING PER PENDEL TEXTILE  
000CR - TREKONTLASTING PER PENDEL TEXTILE

**Materials**

glass BZ

**Ref**

5095.A.G9.BZ.TX2.2M bronze  
5095.A.G9.BZ.TX7.44 bronze  
5095.A.G9.BZ.TXG4.46 bronze  
5095.A.G9.BZ.TXJ.53 bronze

built-up

transparent glass





4998.A.E27/.. - MOBY GOLD - TX

~230V IP20 2 m 0,5 m 05.20.02 CE



suspension - with 2m textile cable and strain relief on lampholder's side  
pendelleuchte - mit 2m Textilkabel und Zugentlastung an Fassung

**Ref**  
4998.A.E27.GC.TX2.2M gold coat  
4998.A.E27.GC.TX4.4 gold coat  
4998.A.E27.GC.TXM.16 gold coat

**Lamptype**  
◀ 1x D45 E27 max. 15W **A** - **E** ▶ 230V

**Dimensions**  
↔ Ø140xH120 - 2000

**Materials**  
glass GC

*built-up*

*gold coated glass*

PENDANTS

4999.A.E27/.. - MOBY RKC - TX

~230V IP20 2 m 0,5 m 05.20.02 CE



suspension - with 2m textile cable and strain relief on lampholder's side  
pendelleuchte - mit 2m Textilkabel und Zugentlastung an Fassung

**Ref**  
4999.A.E27.RKC.TX2.2M red copper coat  
4999.A.E27.RKC.TXG28.28 red copper coat  
4999.A.E27.RKC.TXRK.28 red copper coat

**Lamptype**  
◀ 1x D45 E27 max. 15W **A** - **E** ▶ 230V

**Dimensions**  
↔ Ø140xH120 - 2000

**Materials**  
glass RKC

*built-up*

*red copper coated glass*

4970.B.E27/.. - MOBY GOLD - TX

~230V IP20 2 m 0,5 m 05.20.02 CE



suspension - with 2m textile cable and strain relief on lampholder's side  
pendelleuchte - mit 2m Textilkabel und Zugentlastung an Fassung

**Ref**  
4970.B.E27.GC.TX2.2M gold coat  
4970.B.E27.GC.TX4.4 gold coat  
4970.B.E27.GC.TXM.16 gold coat

**Lamp type**

1x A60 E27 max. 10,5W **A** - **E** 230V

**Dimensions**

Ø180xH140 - Cable 2000

**Options**

000C - TREKONTLASTING PER PENDEL TEXTILE  
000CR - TREKONTLASTING PER PENDEL TEXTILE

**Materials**

glass GC

built-up

gold coated glass

4971.B.E27/.. - MOBY RKC - TX

~230V IP20 2 m 1,000 0,5 m 05.20.02 CE



suspension - with 2m textile cable and strain relief on lampholder's side  
pendelleuchte - mit 2m Textilkabel und Zugentlastung an Fassung

**Ref**  
4971.B.E27.RKC.TX2.2M red copper coat  
4971.B.E27.RKC.TXG28.28 red copper coat  
4971.B.E27.RKC.TXRK.28 red copper coat

**Lamp type**

1x G80 E27 max. 40W **A** - **E** 230V

**Dimensions**

Ø180xH140 - Cable 2000

**Options**

000C - TREKONTLASTING PER PENDEL TEXTILE  
000CR - TREKONTLASTING PER PENDEL TEXTILE

**Materials**

glass RKC

built-up

red copper coated glass

4972.B.E27/.. - MOBY CHR - TX

~230V IP20 2 m 0,5 m 05.20.02 CE



suspension - with 2m textile cable and strain relief on lampholder's side  
pendelleuchte - mit 2m Textilkabel und Zugentlastung an Fassung

**Ref**  
4972.B.E27.SC.TX2.2M silver coat  
4972.B.E27.SC.TXS.14 silver coat  
4972.B.E27.SC.TXS2.14 silver coat

**Lamp type**

1x G80 E27 max. 40W **A** - **E** 230V

**Dimensions**

Ø180xH140 - Cable 2000

**Materials**

glass SC

built-up

silver coated glass

4973.C.E27/.. - MOBY GOLD - TX

~230V IP20 2 m 1,2600 0,5 m 05.20.02 CE



suspension - with 2m textile cable and strain relief on lampholder's side  
pendelleuchte - mit 2m Textilkabel und Zugentlastung an Fassung

**Ref**  
4973.C.E27.GC.TX2.16 gold coat  
4973.C.E27.GC.TXM.16 gold coat

**Lamptype**

1x G80 E27 max. 40W A - E 230V

**Dimensions**

Ø250xH210 - Cable 2000

**Options**

000C - TREKONTLASTING PER PENDEL TEXTILE  
000CR - TREKONTLASTING PER PENDEL TEXTILE

**Materials**

glass GC

built-up

gold coated glass

4974.C.E27/.. - MOBY RKC - TX

~230V IP20 2 m 1,5000 0,5 m 05.20.02 CE



suspension - with 2m textile cable and strain relief on lampholder's side  
pendelleuchte - mit 2m Textilkabel und Zugentlastung an Fassung

**Ref**  
4974.C.E27.RKC.TX2.28 red copper coat  
4974.C.E27.RKC.TXG28.28 red copper coat  
4974.C.E27.RKC.TXRK.28 red copper coat

**Lamptype**

1x G80 E27 max. 40W A - E 230V

**Dimensions**

Ø250xH210 - Cable 2000

**Options**

000C - TREKONTLASTING PER PENDEL TEXTILE  
000CR - TREKONTLASTING PER PENDEL TEXTILE

**Materials**

glass RKC

built-up

red copper coated glass

5127.E27/.. - MOBY PINKY - TX

~230V IP20 2 m 1,2800 0,5 m 05.20.02 CE



suspension - with 2m textile cable and strain relief on lampholder's side  
pendelleuchte - mit 2m Textilkabel und Zugentlastung an Fassung

**Ref**  
5127.E27.PKY.TX2.2M pinky  
5127.E27.PKY.TXG30.2Mpinky

**Lamptype**

1x G80 E27 max. 40W A - E 230V

**Dimensions**

Ø250xH210 - Cable 2000

**Options**

000C - TREKONTLASTING PER PENDEL TEXTILE  
000CR - TREKONTLASTING PER PENDEL TEXTILE

built-up

pink coated glass

4975.C.E27/.. - MOBY SILVER - TX

~230V IP20 2 m 1,1700 0,5 m 05.20.02 CE



suspension - with 2m textile cable and strain relief on lampholder's side  
pendelleuchte - mit 2m Textilkabel und Zugentlastung an Fassung

**Ref**  
4975.C.E27.SC.TX2.14 silver coat  
4975.C.E27.SC.TX7.14 silver coat  
4975.C.E27.SC.TX11.14 silver coat  
4975.C.E27.SC.TXS.14 silver coat

**Lamptype**

1x G80 E27 max. 40W A - E 230V

**Dimensions**

Ø250xH210 - Cable 2000

**Options**

000C - TREKONTLASTING PER PENDEL TEXTILE  
000CR - TREKONTLASTING PER PENDEL TEXTILE

**Materials**

glass SC

built-up

silver coated glass

5096.C.E27/.. - MOBY METAL - TX

~230V



IP20



2 m



1,6600



0,5 m



05.20.02



pendant - with 2m textile cable and strain relief on lampholder's side  
 Pendelleuchte - mit 2m Textilkabel und Zugentlastung an Fassung

**Lamp type**

1x G95 E27 max. 10,5W **A+** - **E** 230V

**Dimensions**

Ø245xH210 - Cable 2000

**Options**

000C - TREKONTLASTING PER PENDEL TEXTILE

000CR - TREKONTLASTING PER PENDEL TEXTILE

**Materials**

aluminium 1M | 29 | 2M | 45

**Ref**

5096.C.E27.1M.TX1	white tex
5096.C.E27.2M.TX2	black tex
5096.C.E27.1M.TXW1	white tex
5096.C.E27.2M.TXW2	black tex
5096.C.E27.29.TX2	black - gold in
5096.C.E27.29.TX4	black - gold in
5096.C.E27.29.TXW2	black - gold in
5096.C.E27.45.TX2	sun gold
5096.C.E27.45.TX4	sun gold
5096.C.E27.45.TXW2	sun gold

built-up

coated glass





5150.3C.E27/.. - MOBY 3 GLASS

~230V IP20 1,5 m 0,5 m 05.20.02 CE

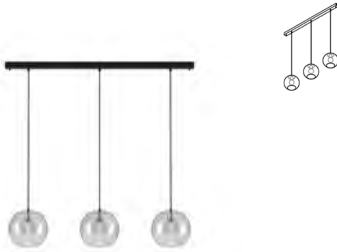

pendant - with 3x Moby Ø250 - 1,5m textile cable  
 Pendelleuchte - mit 3x Moby Ø250 - 1,5M Textilkabel

Lamp type

3x A60 E27 max. 60W **A** - **E** 230V

Dimensions

L1200xB250xH1755 - Cable 1500  
 Base - L1200xB50xH40  
 Glass - Ø250

Materials

aluminium 2M | 53  
 brass 16

Ref

5150.3C.E27.2M.BZ.TX2 black tex  
 5150.3C.E27.2M.TR.TX2 black tex  
 5150.3C.E27.2M.SG.TX2 black tex  
 5150.3C.E27.16.TR.TXM satin gold  
 5150.3C.E27.53.BZ.TXJ bronze-brown  
 5150.3C.E27.216.TR.TX2 black - gold  
 5150.3C.E27.216.TR.TXM black - gold

built-up

5150.5C.E27/.. - MOBY 5 GLASS

~230V IP20 1,5 m 0,5 m 05.20.02 CE



pendant - with 5x Moby Ø250 - 1,5m textile cable  
 Pendelleuchte - mit 5x Moby Ø250 - 1,5M Textilkabel

Lamp type

5x A60 E27 max. 60W **A** - **E** 230V

Dimensions

L1800xB25xH25 - Cable 1500  
 Base - L1800xB50xH40  
 Glass - Ø250

Materials

aluminium 2M | 53  
 brass 16

Ref cat (LONG)

5150.5C.E27.2M.BZ.TX2 black tex  
 5150.5C.E27.2M.TR.TX2 black tex  
 5150.5C.E27.2M.SG.TX2 black tex  
 5150.5C.E27.16.TR.TXM satin gold  
 5150.5C.E27.53.BZ.TXJ bronze-brown  
 5150.5C.E27.216.TR.TX2 black - gold  
 5150.5C.E27.216.TR.TXM black - gold

built-up

5151.3C.SH/.. - MOBY 3 SH GLASS

~230V IP20 1,5 m 0,5 m 05.20.02 CE

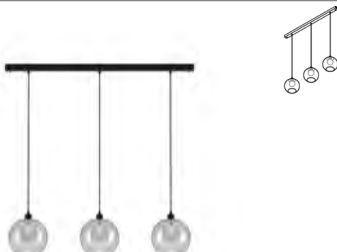

pendant - with 3x Moby Ø250 - 1,5m textile cable  
 Pendelleuchte - mit 3x Moby Ø250 - 1,5M Textilkabel

Lamp type

3x A60 E27 max. 60W **A** - **E** 230V

Dimensions

L1200xB250xH1755 - Cable 1500  
 Base - L1200xB50xH40  
 Glass - Ø250

Materials

aluminium 2M | 53  
 brass 16

Ref

5151.3C.SH.2M.BZ.TX2 black tex  
 5151.3C.SH.2M.TR.TX2 black tex  
 5151.3C.SH.2M.SG.TX2 black tex  
 5151.3C.SH.16.TR.TXM satin gold  
 5151.3C.SH.53.BZ.TXJ bronze-brown  
 5151.3C.SH.216.TR.TX2 black - gold  
 5151.3C.SH.216.TR.TXM black - gold

built-up

5151.5C.SH/.. - MOBY SH GLASS

~230V IP20 1,5 m 0,5 m 05.20.02 CE

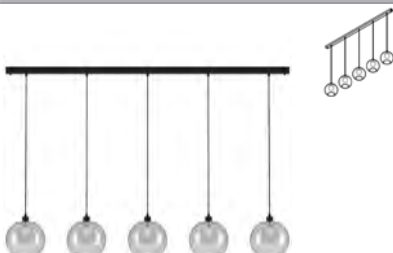

pendant - with 5x Moby Ø250 - 1,5m textile cable  
 Pendelleuchte - mit 5x Moby Ø250 - 1,5M Textilkabel

Lamp type

5x A60 E27 max. 60W **A** - **E** 230V

Dimensions

L1800xB250xH1755 - Cable 1500  
 L560xB60  
 Base - L1200xB50xH40  
 Glass - Ø250

Materials

aluminium 2M | 53  
 brass 16

Ref cat (LONG)

5151.5C.SH.2M.BZ.TX2 black tex  
 5151.5C.SH.2M.TR.TX2 black tex  
 5151.5C.SH.2M.SG.TX2 black tex  
 5151.5C.SH.16.TR.TXM satin gold  
 5151.5C.SH.53.BZ.TXJ bronze-brown  
 5151.5C.SH.216.TR.TX2 black - gold  
 5151.5C.SH.216.TR.TXM black - gold

built-up

5152.3.E27/.. - MOBY GLASS

~230V IP20 1,5 m 0,5 m 05.20.02 CE



pendant - with 2x Moby Ø180 and 1x Moby Ø250 - 1,5m textile cable  
 Pendelleuchte - mit 2x Moby Ø180 und 1x Moby Ø250 - 1,5m Textilkabel

**Lamp type**  
 3x A60 E27 max. 60W **A** - **E** 230V

**Dimensions**  
 Ø390xH1676 - Cable 1500  
 Ø220  
 Glass - Ø250  
 Glass - Ø180  
 Base - Ø250xH26

**Materials**  
 aluminium 2M | 53

**Ref**  
 5152.3.E27.2M.BZ.TX2 black tex  
 5152.3.E27.2M.TR.TX2 black tex  
 5152.3.E27.2M.SG.TX2 black tex  
 5152.3.E27.53.BZ.TXJ bronze-brown  
 5152.3.E27.216.TR.TX2 black - gold  
 5152.3.E27.216.TR.TXM black - gold

built-up

5152.5.E27/.. - MOBY GLASS

~230V IP20 1,5 m 0,5 m 05.20.02 CE



pendant - with 3x Moby Ø250, 1x Moby Ø180 and 1x Moby Ø140 - 1,5m textile cable  
 Pendelleuchte - mit 3x Moby Ø250, 1x Moby Ø180 und 1x Moby Ø140 - 1,5m Textilkabel

**Lamp type**  
 5x A60 E27 max. 60W **A** - **E** 230V

**Dimensions**  
 Ø530xH1676 - Cable 1500  
 Ø370  
 Base - Ø400xH28  
 Glass - Ø250  
 Glass - Ø180  
 Glass - Ø140

**Materials**  
 aluminium 2M | 53

**Ref cat (LONG)**  
 5152.5.E27.2M.BZ.TX2 black tex  
 5152.5.E27.2M.TR.TX2 black tex  
 5152.5.E27.2M.SG.TX2 black tex  
 5152.5.E27.53.BZ.TXJ bronze-brown  
 5152.5.E27.216.TR.TX2 black - gold  
 5152.5.E27.216.TR.TXM black - gold

built-up

5153.SH.5/.. - MOBY SH GLASS

~230V IP20 1,5 m 0,5 m 05.20.02 CE



pendant - with 3x Moby Ø250, 1x Moby Ø180 and 1x Moby Ø140 - 1,5m textile cable  
 Pendelleuchte - mit 3x Moby Ø250, 1x Moby Ø180 und 1x Moby Ø140 - 1,5m Textilkabel

**Lamp type**  
 5x A60 E27 max. 60W **A** - **E** 230V

**Dimensions**  
 Ø530xH1676 - Cable 1500  
 Ø370  
 Base - Ø400xH28  
 Glass - Ø250  
 Glass - Ø180  
 Glass - Ø140

**Materials**  
 aluminium 2M | 53

**Ref cat (LONG)**  
 5153.SH.5.2M.BZ.TX2 black tex  
 5153.SH.5.2M.TR.TX2 black tex  
 5153.SH.5.2M.SG.TX2 black tex  
 5153.SH.5.53.BZ.TXJ bronze-brown  
 5153.SH.5.216.TR.TX2 black - gold  
 5153.SH.5.216.TR.TXM black - gold

built-up

5154.4.E27/.. - MOBY GLASS MIX

~230V IP20 1,5 m 0,5 m 05.20.02 CE



pendant - combination 4x Moby - 1,5m textile cable  
 Pendelleuchte - Kombination 4x Moby - 1,5m Textilkabel

**Lamp type**

4x A60 E27 max. 60W **A** - **E** 230V

**Dimensions**

Ø525xH1741 - Cable 1500

Ø370

Base - Ø400xH28

Glass - Ø200

Glass - Ø250

**Materials**

aluminium 2M

**Ref**

5154.4.E27.2M.TR.TX2 black tex

5154.4.E27.216.TR.TX2 black - gold

5154.4.E27.216.TR.TXM black - gold

built-up

5155.7.E27/.. - MOBY GLASS MIX

~230V IP20 1,5 m 0,5 m 05.20.02 CE



pendant - combination 7x Moby - 1,5m textile cable  
 Pendelleuchte - Kombination 7x Moby - 1,5m Textilkabel

**Lamp type**

4x A60 E27 max. 60W **A** - **E** 230V

**Dimensions**

Ø650xH1741 - Cable 1500

Ø350

Base - Ø500xH28

Glass - Ø250

Glass - Ø180

Glass - Ø140

**Materials**

aluminium COMBI

**Ref cat (LONG)**

5155.7.E27.COMBI combi

built-up

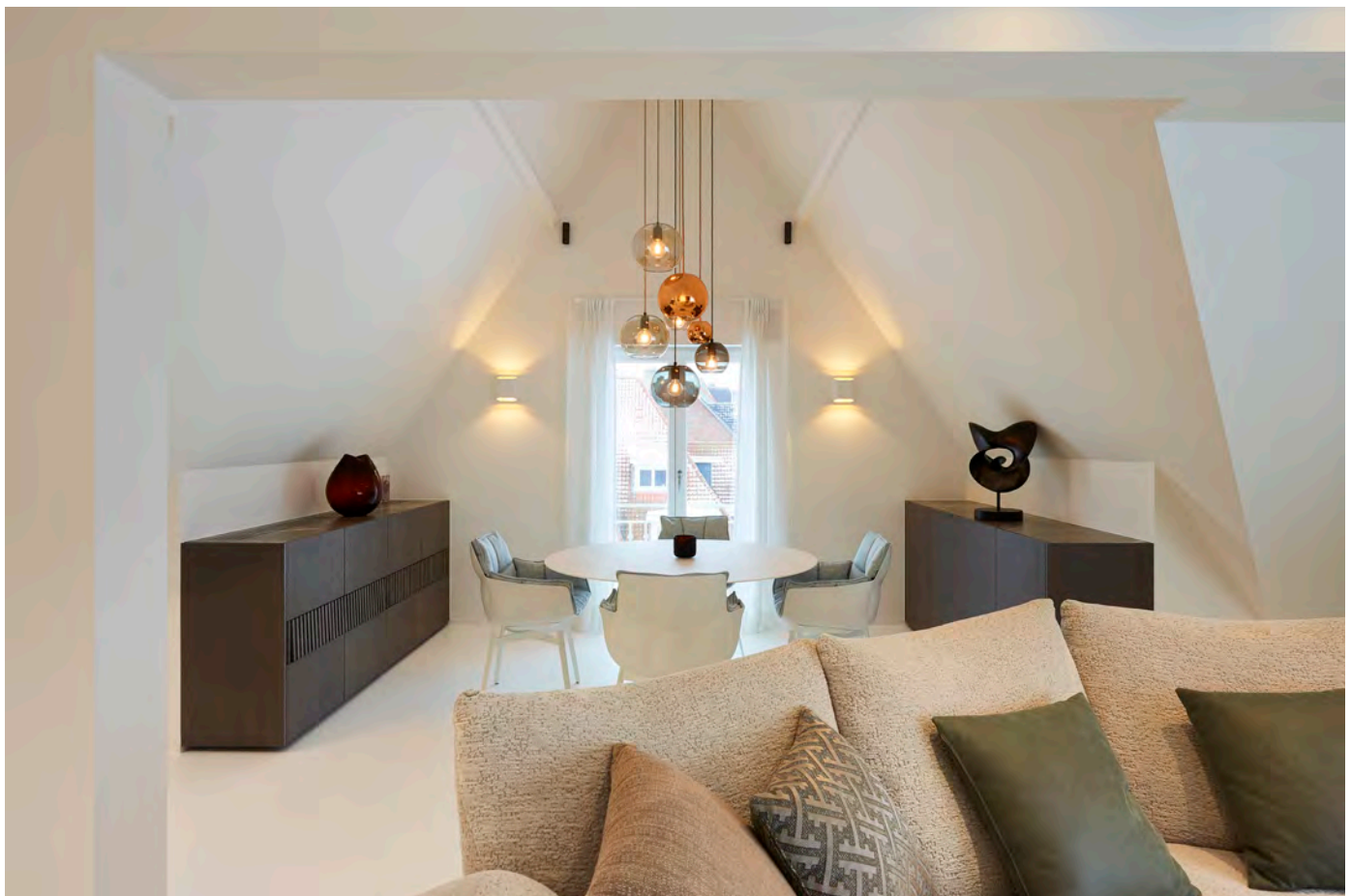

5156.3B.E27/.. - MOBY GLASS

~230V IP20 0,8 m 0,5 m 05.20.02 CE

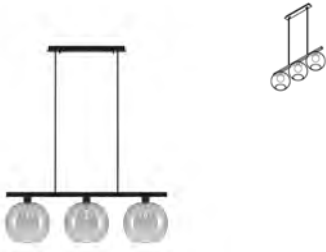

built-up

pendant with swivel - rod can be shortened - 3x Moby Ø180  
 Pendelleuchte mit Kugelgelenk - kürzbare Stange - 3x Moby Ø180

**Lamp type**  
 3x A60 E27 max. 60W **A** - **E** 230V

**Dimensions**  
 L1000xB250xH1100 - Bar 800  
 L450xB60xH30  
 Glass - Ø250  
 Base - L1000

**Materials**  
 aluminium 1M | 2M | 53

**Ref**

5156.3B.E27.1M.BZ	white tex
5156.3B.E27.1M.TR	white tex
5156.3B.E27.1M.SG	white tex
5156.3B.E27.2M.BZ	black tex
5156.3B.E27.2M.TR	black tex
5156.3B.E27.2M.SG	black tex
5156.3B.E27.53.BZ	bronze-brown

5156.5B.E27/.. - MOBY GLASS

~230V IP20 0,8 m 0,5 m 05.20.02 CE

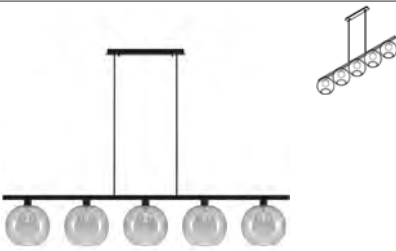

built-up

pendant with swivel - rod can be shortened - 5x Moby Ø180  
 Pendelleuchte mit Kugelgelenk - kürzbare Stange - 5x Moby Ø180

**Lamp type**  
 3x A60 E27 max. 60W **A** - **E** 230V

**Dimensions**  
 L1600xB250xH1100 - Bar 800  
 L600xB60xH30  
 Glass - Ø200  
 Base - L1600

**Materials**  
 aluminium 1M | 2M | 53

**Ref**

5156.5B.E27.1M.BZ	white tex
5156.5B.E27.1M.TR	white tex
5156.5B.E27.1M.SG	white tex
5156.5B.E27.2M.BZ	black tex
5156.5B.E27.2M.TR	black tex
5156.5B.E27.2M.SG	black tex
5156.5B.E27.53.BZ	bronze-brown

5162.3E/.. - MOBY GLASS

~230V IP20 1,5 m 0,5 m 05.20.02 CE

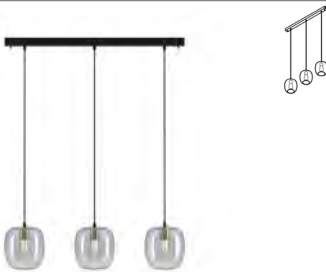

built-up

pendant - with 3x Moby - 1,5m textile cable  
 Pendelleuchte - mit 3x Moby - 1,5m Textilkabel

**Lamp type**  
 3x A60 E27 max. 60W **A** - **E** 230V

**Dimensions**  
 L900xB200xH1755 - Cable 1500  
 Glass - Ø200xH215  
 Base - L900xB50xH40

**Materials**  
 aluminium 1M | 2M  
 brass 16

**Ref**

5162.3E.1M.TR.TX1	white tex
5162.3E.1M.ST.TX1	white tex
5162.3E.2M.TR.TX2	black tex
5162.3E.2M.ST.TX2	black tex
5162.3E.16.TR.TXM	satin gold
5162.3E.216.TR.TX2	black - gold
5162.3E.216.TR.TXM	black - gold



5157.2E.3M/.. - MOBY GLASS

~230V IP20 1,5 m 0,5 m 05.20.50 CE



built-up

pendant - combination 2x Moby and 3x Mero - 1,5m textile cable  
 Pendelleuchte - Kombination 2x Moby und 3x Mero - 1,5m Textilkabel

Lamp type

2x A60 E27 max. 60W **A** - **E** 230V  
 3x LED AC 700lm CRI92 max. 9,5W **A+** 230V

Dimensions

L1400xB250xH1755 - Cable 1500  
 Base - L1400xB50xH40  
 Glass - Ø200  
 Tube - Ø60xH300

Materials

aluminium 1M | 2M  
 brass 16

Ref cat (LONG)

5157.2E.3M.1M.TR.TX1 white tex  
 5157.2E.3M.1M.ST.TX1 white tex  
 5157.2E.3M.2M.TR.TX2 black tex  
 5157.2E.3M.2M.ST.TX2 black tex  
 5157.2E.3M.16.TR.TXM satin gold  
 5157.2E.3M.216.TR.TX2 black - gold  
 5157.2E.3M.216.TR.TXM black - gold

5158.2C.3M/.. - MOBY GLASS

~230V IP20 1,5 m 0,5 m 05.20.50 CE



built-up

pendant - combination 2x Moby and 3x Mero - 1,5m textile cable  
 Pendelleuchte - Kombination 2x Moby und 3x Mero - 1,5m Textilkabel

Lamp type

2x A60 E27 max. 60W **A** - **E** 230V  
 3x LED AC 700lm CRI92 max. 9,5W **A+** 230V

Dimensions

L1400xB250xH1755 - Cable 1500  
 Base - L1400xB50xH40  
 Glass - Ø250  
 Glass - Ø180

Materials

aluminium 1M | 2M  
 brass 16

Ref

5158.2C.3M.1M.TR.TX1 white tex  
 5158.2C.3M.1M.ST.TX1 white tex  
 5158.2C.3M.2M.TR.TX2 black tex  
 5158.2C.3M.2M.ST.TX2 black tex  
 5158.2C.3M.16.TR.TXM satin gold  
 5158.2C.3M.216.TR.TX2 black - gold  
 5158.2C.3M.216.TR.TXM black - gold

5159.2B.3C/.. - MOBY GLASS

~230V IP20 1,5 m 0,5 m 05.20.02 CE



built-up

pendant - with 3x Moby Ø250 and 2x Moby Ø180 - 1,5m textile cable  
 Pendelleuchte - mit 3x Moby Ø250 und 2x Moby Ø180 - 1,5m Textilkabel

Lamp type

5x A60 E27 max. 60W **A** - **E** 230V

Dimensions

L1400xB250xH1755 - Cable 1500  
 Base - L1400xB50xH40  
 Glass - Ø250  
 Tube - Ø60xH300

Materials

aluminium 1M | 2M | 53  
 brass 16

Ref cat (LONG)

5159.2B.3C.1M.BZ.TX1 white tex  
 5159.2B.3C.1M.TR.TX1 white tex  
 5159.2B.3C.1M.SG.TX1 white tex  
 5159.2B.3C.2M.BZ.TX2 black tex  
 5159.2B.3C.2M.TR.TX2 black tex  
 5159.2B.3C.2M.SG.TX2 black tex  
 5159.2B.3C.16.TR.TXM satin gold  
 5159.2B.3C.53.BZ.TXJ bronze-brown  
 5159.2B.3C.216.TR.TX2 black - gold  
 5159.2B.3C.216.TR.TXM black - gold





1507.5.E27/.. - CLEO - M12

~230V IP20 1 m 4,7000 0,5 m 05.20.02 CE



pendant - fixed  
Pendelleuchte - fest

Lamp type

5x A60 E27 max. 10,5W **A** - **E** 230V

Dimensions

B820xH1150 - Bar 1000

Ø125xH25

Glass - Ø180

Materials

aluminium 1M | 2M  
brass 16

Ref

1507.5.E27.1M.TR	white tex
1507.5.E27.1M.16.TR	white tex
1507.5.E27.2M.SG	black tex
1507.5.E27.2M.TR	black tex
1507.5.E27.2M.16.SG	black tex
1507.5.E27.2M.16.TR	black tex
1507.5.E27.16.SG	satin gold

built-up  
other colours of glass on request  
andere Glasfarben auf Anfrage

1512/.. - CLEO - M12

~230V IP20 0,1 m 1,3000 0,5 m 05.20.02 CE



pendant - round - fixed  
Pendelleuchte - rund - fest

Lamp type

3x G95 E27 max. 10,5W **A** - **E** 230V

Dimensions

L300xB580xH440 - Bar 100

Materials

aluminium 1M | 2M

Ref

1512.1M	white tex
1512.1M.16	white tex
1512.2M	black tex
1512.2M.16	black tex

built-up

1513/.. - CLEO - M12

~230V IP20 0,5 m 05.20.02 CE



pendant - fixed  
Pendelleuchte - fest

Lamp type

4x G95 E27 max. 10,5W **A** - **E** 230V

Dimensions

L280xB280xH820

Materials

aluminium 1M | 2M

Ref

1513.1M	white tex
1513.1M.16	white tex
1513.2M	black tex
1513.2M.16	black tex

built-up

1514/.. - CLEO - B3

~230V



IP20



0,8 m



0,5 m



pendant with swivel and built-up base - fixed  
 Pendelleuchte mit Kugelgelenk und Aufbaurosette - fest

**Lamp type**

2x G95 E27 max. 10,5W **A** - **E** 230V

**Dimensions**

B7000xH1000 - Bar 800

Ø60xH25

**Materials**

aluminium 1M | 2M

**Ref cat (LONG)**

1514.1M	white tex
1514.1M.16	white tex
1514.2M	black tex
1514.2M.16	black tex

built-up

1515/.. - CLEO - B3

~230V



IP20



0,8 m



0,5 m



pendant with swivel and built-up base - fixed  
 Pendelleuchte mit Kugelgelenk und Aufbaurosette - fest

**Lamp type**

2x G80 E27 max. 40W **A** - **E** 230V

**Dimensions**

B900xH1000 - Bar 800

Glass - Ø250

**Materials**

aluminium 1M | 2M

**Ref**

1515.1M.TR	white tex
1515.1M.16.TR	white tex
1515.2M.SG	black tex
1515.2M.TR	black tex
1515.2M.16.SG	black tex
1515.2M.16.TR	black tex

built-up  
 other colours of glass on request  
 andere glasfarben auf anfrage





1509/.. - CLEO - M12

~230V

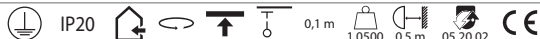

pendant - directional - asymmetric  
 Pendelleuchte - schwenkbar - asymmetrisch

**Lamp type**

2x G95 E27 max. 10,5W **A+** - **E** 230V

**Dimensions**

B830xH180 - Bar 100

**Materials**

aluminium 1M | 2M

**Ref**

1509.1M	white tex
1509.1M.16	white tex
1509.2M	black tex
1509.2M.16	black tex

built-up

1508/.. - CLEO - M12

~230V

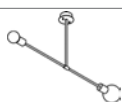

pendant - fixed - asymmetric  
 Pendelleuchte - fest - asymmetrisch

**Lamp type**

2x G95 E27 max. 10,5W **A+** - **E** 230V

**Dimensions**

B110xH86 - Bar 800

Ø60xH25

**Materials**

aluminium 1M | 2M

**Ref**

1508.1M	white tex
1508.1M.16	white tex
1508.2M	black tex
1508.2M.16	black tex

built-up



5550.E27/.. - SHAKE METAL

~230V IP20 1,5 m 0,5 m 05.20.02 CE



pendant - down - with 1,5m textile cable and strain relief on lampholder's side  
 Pendelleuchte - down - mit 1,5m Textilkabel und Zugentlastung an Fassung

**Lamp type**  
 1x A60 E27 max. 12W **A** - **E** 230V  
 or 1x ST64 E27 max. 40W **A** - **E** 230V

**Dimensions**  
 Ø180xH300 - Cable 1500

**Materials**  
 aluminium 14 | 1M | 29 | 47 | 49 | 141 | 142  
 aluminium / red copper 281 | 282  
 brass 16  
 red copper 28

Ref	
5550.E27.141.TX1	alu - white
5550.E27.142.TX2	alu - black
5550.E27.1M.2M.TX2	white tex
5550.E27.1M.TX1	white tex
5550.E27.14.TX11	alu satin
5550.E27.16.TXM	satin gold
5550.E27.29.TX2	black - gold in
5550.E27.28.TXRK	rosé
5550.E27.47.TX2	black - white in
5550.E27.49.TX1	white - gold in
5550.E27.282.TX2	RC - black
5550.E27.281.TX1	RC - white
5550.E27.216.TX2	black - gold

built-up

5548.LED/.. - SHAKE METAL

~230V IP20 LED C 1,5 m 0,5 m 05.20.02 CE



pendant - down - with 1,5m textile cable and strain relief on lampholder's side  
 Pendelleuchte - down - mit 1,5m Textilkabel und Zugentlastung an Fassung

**Lamp type**  
 1x LED 630lm CRI90 max. 6W 230V

**Dimensions**  
 Ø180xH300 38° reflector - Cable 1500

Ref	
5548.LED.141.TX1	NW   WW
5548.LED.142.TX2	NW   WW
5548.LED.1M.TX1	NW   WW
5548.LED.14.TX11	NW   WW
5548.LED.16.TXM	NW   WW
5548.LED.29.TX2	NW   WW
5548.LED.28.TXRK	NW   WW
5548.LED.47.TX2	NW   WW
5548.LED.49.TX1	NW   WW
5548.LED.282.TX2	NW   WW
5548.LED.281.TX1	NW   WW
5548.LED.216.TX2	NW   WW

built-up

5553.E27/.. - SHAKE METAL

~230V IP20 1,5 m 0,5 m 05.20.02 CE



pendant - down - with 1,5m textile cable and strain relief on lampholder's side  
 Pendelleuchte - down - mit 1,5m Textilkabel und Zugentlastung an Fassung

**Lamp type**  
 1x A60 E27 max. 12W **A** - **E** 230V

**Dimensions**  
 Ø165xH230 - Cable 1500

**Materials**  
 aluminium 14 | 1M | 29 | 47 | 49 | 141 | 142  
 aluminium / red copper 281 | 282  
 brass 16  
 red copper 28

Ref	
5553.E27.141.TX1	alu - white
5553.E27.142.TX2	alu - black
5553.E27.1M.2M.TX2	white tex
5553.E27.1M.TX1	white tex
5553.E27.14.TX11	alu satin
5553.E27.16.TXM	satin gold
5553.E27.29.TX2	black - gold in
5553.E27.28.TXRK	rosé
5553.E27.47.TX2	black - white in
5553.E27.49.TX2	white - gold in
5553.E27.282.TX2	RC - black
5553.E27.281.TX1	RC - white
5553.E27.216.TX2	black - gold

built-up





5549.LED/.. - SHAKE METAL

~230V



IP20



1,5 m



0,5 m



pendant - down - with 1,5m textile cable and strain relief on lampholder's side  
 Pendelleuchte - down - mit 1,5m Textilkabel und Zugentlastung an Fassung

Lamptype

1x LED 630lm CRI90 max. 6W 230V

Dimensions

Ø165xH230 / 38° reflector - Cable 1500

Ref

5549.LED.141.TX1	NW   WW
5549.LED.142.TX2	NW   WW
5549.LED.1M.TX1	NW   WW
5549.LED.14.TX11	NW   WW
5549.LED.16.TXM	NW   WW
5549.LED.29.TX2	NW   WW
5549.LED.28.TXRK	NW   WW
5549.LED.47.TX2	NW   WW
5549.LED.49.TX1	NW   WW
5549.LED.282.TX2	NW   WW
5549.LED.281.TX1	NW   WW
5549.LED.216.TX2	NW   WW

built-up





5551.E27/.. - SHAKE METAL

~230V IP20 1,5 m 0,5 m 05.20.02 CE



pendant - down - with 1,5m textile cable and strain relief on lampholder's side  
 Pendelleuchte - down - mit 1,5m Textilkabel und Zugentlastung an Fassung

**Lamp type**  
 1x A60 E27 max. 12W **A** - **E** 230V

**Dimensions**  
 Ø165xH155 - Cable 1500

**Materials**  
 aluminium 14 | 1M | 29 | 2M | 47 | 49  
 brass 16  
 red copper 28

Ref	
5551.E27.1M.TX1	white tex
5551.E27.2M.TX2	black tex
5551.E27.14.TX11	alu satin
5551.E27.16.TXM	satin gold
5551.E27.29.TX2	black - gold in
5551.E27.28.TXRK	rosé
5551.E27.47.TX2	black - white in
5551.E27.49.TX1	white - gold in

built-up

5567.LED/.. - SHAKE LED

~230V IP20 LED C 1,5 m 0,5 m 05.20.50 CE



pendant - down - with 1,5m textile cable and strain relief on lampholder's side  
 Pendelleuchte - down - mit 1,5m Textilkabel und Zugentlastung an Fassung

**Lamp type**  
 1x LED 630lm CRI90 max. 6W 230V

**Dimensions**  
 Ø165xH155 - Cable 1500

Ref	
5567.LED.1M.TX1	NW   WW
5567.LED.2M.TX2	NW   WW
5567.LED.14.TX11	NW   WW
5567.LED.16.TXM	NW   WW
5567.LED.29.TX2	NW   WW
5567.LED.28.TXRK	NW   WW
5567.LED.47.TX2	NW   WW
5567.LED.49.TX1	NW   WW

built-up

5552.E27/.. - SHAKE METAL

~230V IP20 1,5 m 0,5 m 05.20.02 CE



pendant - down - with 1,5m textile cable and strain relief on lampholder's side  
 Pendelleuchte - down - mit 1,5m Textilkabel und Zugentlastung an Fassung

**Lamp type**  
 1x A60 E27 max. 12W **A** - **E** 230V  
 or 1x ST64 E27 max. 40W **A** - **E** 230V

**Dimensions**  
 Ø180xH225 - Cable 1500

**Materials**  
 aluminium 14 | 1M | 29 | 2M | 47 | 49  
 brass 16  
 red copper 28

Ref	
5552.E27.1M.TX1	white tex
5552.E27.2M.TX2	black tex
5552.E27.14.TX11	alu satin
5552.E27.16.TXM	satin gold
5552.E27.29.TX2	black - gold in
5552.E27.28.TXRK	rosé
5552.E27.47.TX2	black - white in
5552.E27.49.TX1	white - gold in

built-up

5568.LED/.. - SHAKE LED

~230V IP20 LED C 1,5 m 0,5 m 05.20.50 CE



pendant - down - with 1,5m textile cable and strain relief on lampholder's side  
 Pendelleuchte - down - mit 1,5m Textilkabel und Zugentlastung an Fassung

**Lamp type**  
 1x LED 630lm CRI90 max. 6W 230V

**Dimensions**  
 Ø180xH225 - Cable 1500

Ref	
5568.LED.1M.TX1	NW
5568.LED.2M.TX2	NW
5568.LED.14.TX11	NW
5568.LED.16.TXM	NW
5568.LED.29.TX2	NW
5568.LED.28.TXRK	NW
5568.LED.47.TX2	NW
5568.LED.49.TX1	NW

built-up

PENDANTS

5555.E27/.. - SHAKE GLASS

~230V IP20 1,5 m 0,5 m 05.20.02 CE



pendant - down - with 1,5m cable - with glass  
 Pendelleuchte - down - mit 1,5m Kabel - mit Glas

Lamp type

1x A60 E27 max. 12W **A** - **E** 230V  
 or 1x ST64 E27 max. 40W **A** - **E** 230V

Dimensions

Ø180xH300 - Cable 1500

Materials

aluminium 14 | 1M | 2M  
 brass 16  
 red copper 28

Ref

5555.E27.1M.TR.TX1 white tex  
 5555.E27.1M.ST.TX1 white tex  
 5555.E27.2M.TR.TX2 black tex  
 5555.E27.2M.ST.TX2 black tex  
 5555.E27.14.TR.TX11 alu satin  
 5555.E27.14.ST.TX11 alu satin  
 5555.E27.16.TR.TXM satin gold  
 5555.E27.16.ST.TXM satin gold  
 5555.E27.28.TR.TXRK rosé  
 5555.E27.28.ST.TXRK rosé

built-up

5556.E27/.. - SHAKE GLASS

~230V IP20 1,5 m 0,5 m 05.20.02 CE



pendant - down - with 1,5m cable - with glass  
 Pendelleuchte - down - mit 1,5m Kabel - mit Glas

Lamp type

1x A60 E27 max. 12W **A** - **E** 230V

Dimensions

Ø165xH155 - Cable 1500

Materials

glass ST | TR

Ref

5556.E27.TR.1M.TX1 transparent  
 5556.E27.TR.2M.TX2 transparent  
 5556.E27.TR.14.TX11 transparent  
 5556.E27.TR.16.TXM transparent  
 5556.E27.TR.28.TXRK transparent  
 5556.E27.ST.1M.TX1 steel  
 5556.E27.ST.2M.TX2 steel  
 5556.E27.ST.14.TX11 steel  
 5556.E27.ST.16.TXM steel  
 5556.E27.ST.28.TXRK steel

built-up

5557.E27/.. - SHAKE GLASS

~230V IP20 1,5 m 0,5 m 05.20.02 CE



pendant - down - with 1,5m cable - with glass  
 Pendelleuchte - down - mit 1,5m Kabel - mit Glas

Lamp type

1x A60 E27 max. 12W **A** - **E** 230V  
 or 1x ST64 E27 max. 40W **A** - **E** 230V

Dimensions

Ø180xH225 - Cable 1500

Materials

glass ST | TR

Ref

5557.E27.TR.1M.TX1 transparent  
 5557.E27.TR.2M.TX2 transparent  
 5557.E27.TR.14.TX11 transparent  
 5557.E27.TR.16.TXM transparent  
 5557.E27.TR.28.TXRK transparent  
 5557.E27.ST.1M.TX1 steel  
 5557.E27.ST.2M.TX2 steel  
 5557.E27.ST.14.TX11 steel  
 5557.E27.ST.16.TXM steel  
 5557.E27.ST.28.TXRK steel

built-up

5570.LED/.. - SHAKE 3 LED

~230V  IP20  1,5 m  0,5 m  



pendant - down - with 3x 1,5m textile cable on Juba base  
 Pendelleuchte - down - mit 3x 1,5m Textilkabel auf Basis Juba

**Lamp type**  
 3x LED 630lm CRI90 max. 6W 230V

**Dimensions**  
 L900xB180xH1763 - Cable 1500  
 Base - L900xB50xH40

**Ref cat (LONG)**

5570.LED.1M.TX1	WW
5570.LED.2M.TX2	WW
5570.LED.16.TXM	WW
5570.LED.116.TX1	WW
5570.LED.216.TX2	WW
5570.LED.228.TX2	WW
5570.LED.128.TX1	WW
5570.LED.MIX16.TX2	WW
5570.LED.MIX28.TX2	WW

built-up

PENDANTS

5571.LED/.. - SHAKE 3 LED

~230V  IP20  1,5 m  0,5 m  



pendant - down - with 3x 1,5m textile cable on Juba base  
 Pendelleuchte - down - mit 3x 1,5m Textilkabel auf Basis Juba

**Lamp type**  
 3x LED 630lm CRI90 max. 6W 230V

**Dimensions**  
 L900xB150xH1650 - Cable 1500  
 Base - L900xB50xH40

**Ref**

5571.LED.1M.TX1	NW
5571.LED.2M.TX2	NW
5571.LED.16.TXM	NW
5571.LED.116.TX1	NW
5571.LED.216.TX2	NW
5571.LED.228.TX2	NW
5571.LED.128.TX1	NW

built-up

5572.LED/.. - SHAKE 3 LED

~230V  IP20  1,5 m  0,5 m  



pendant - down - with 3x 1,5m textile cable on Juba base  
 Pendelleuchte - down - mit 3x 1,5m Textilkabel auf Basis Juba

**Lamp type**  
 3x LED 630lm CRI90 max. 6W 230V





**Dimensions**  
 L900xB180xH1727 - Cable 1500  
 Base - L900xB50xH40

**Ref**

5572.LED.1M.TX1	WW
5572.LED.2M.TX2	NW
5572.LED.16.TXM	WW
5572.LED.116.TX1	NW
5572.LED.216.TX2	NW
5572.LED.228.TX2	NW
5572.LED.128.TX1	WW

built-up

5573.LED/.. - SHAKE 3 LED

~230V  IP20  1,5 m   



pendant - down - with 3x 1,5m textile cable on base Rondo Box  
 Pendelleuchte - down - mit 3x 1,5m Textilkabel auf Basis Rondo Box

**Lamp type**

 3x LED 630lm CRI90 max. 6W 230V

**Dimensions**

↔ Ø350xH1715 - Cable 1500  
 Base - Ø350xH28

**Ref cat (LONG)**

5573.LED.1M.TX1	WW
5573.LED.2M.TX2	WW
5573.LED.16.TXM	WW
5573.LED.116.TX1	WW
5573.LED.216.TX2	WW
5573.LED.228.TX2	WW
5573.LED.128.TX1	WW
5573.LED.MIX16.TX2	WW
5573.LED.MIX28.TX2	WW

built-up

5574.LED/.. - SHAKE 5 LED

~230V  IP20  1,5 m   



pendant - down - with 5x 1,5m textile cable on base Juba  
 Pendelleuchte - down - mit 5x 1,5m Textilkabel auf Basis Juba

**Lamp type**

 5x LED 630lm CRI90 max. 6W 230V

**Dimensions**

↔ L1600xB180xH1790 - Cable 1500  
 Base - L1600xB50xD40

**Ref cat (LONG)**

5574.LED.1M.TX1	NW   WW
5574.LED.2M.TX2	NW   WW
5574.LED.16.TXM	NW   WW
5574.LED.116.TX1	NW   WW
5574.LED.216.TX2	NW   WW
5574.LED.228.TX2	NW   WW
5574.LED.128.TX1	NW   WW

built-up





5575.E27/.. - SHAKE 3 GLASS

~230V IP20 1,5 m 0,5 m 05.20.02 CE



pendant - down - with 3x 1,5m textile cable on Juba base  
 Pendelleuchte - down - mit 3x 1,5m Textilkabel auf Basis Juba

**Lamp type**

3x A60 E27 max. 10,5W ▶ ▶ **230V**  
 or 3x ST64 E27 max. 40W ▶ ▶ **230V**

**Dimensions**

L900xB180xH1800 - Cable 1500  
 Base - L900xB50xH40

**Materials**

aluminium 1M | 2M  
 aluminium / red copper 128 | 228  
 brass 16

**Ref cat (LONG)**

5575.E27.1M.TR.TX1	white tex
5575.E27.1M.ST.TX1	white tex
5575.E27.2M.TR.TX2	black tex
5575.E27.2M.ST.TX2	black tex
5575.E27.16.TR.TXM	satin gold
5575.E27.16.ST.TXM	satin gold
5575.E27.116.TR.TX1	white - gold
5575.E27.116.ST.TX1	white - gold
5575.E27.216.TR.TX2	black - gold
5575.E27.216.ST.TX2	black - gold
5575.E27.228.TR.TX2	black - RC
5575.E27.228.ST.TX2	black - RC
5575.E27.128.TR.TX1	white - RC
5575.E27.128.ST.TX1	white - RC

built-up

PENDANTS

5576.E27/.. - SHAKE 3 GLASS

~230V IP20 1,5 m 0,5 m 05.20.02 CE

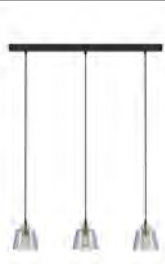

pendant - down - with 3x 1,5m textile cable on Juba base  
 Pendelleuchte - down - mit 3x 1,5m Textilkabel auf Basis Juba

**Lamp type**

3x A60 E27 max. 10,5W ▶ ▶ **230V**

**Dimensions**

L900xB150xH1688 - Cable 1500  
 Base - L900xB50xH40

**Materials**

aluminium 1M | 2M  
 aluminium / red copper 128 | 228  
 brass 16

**Ref**

5576.E27.1M.TR.TX1	white tex
5576.E27.1M.ST.TX1	white tex
5576.E27.2M.TR.TX2	black tex
5576.E27.2M.ST.TX2	black tex
5576.E27.16.TR.TXM	satin gold
5576.E27.16.ST.TXM	satin gold
5576.E27.116.TR.TX1	white - gold
5576.E27.116.ST.TX1	white - gold
5576.E27.216.TR.TX2	black - gold
5576.E27.216.ST.TX2	black - gold
5576.E27.228.TR.TX2	black - RC
5576.E27.228.ST.TX2	black - RC
5576.E27.128.TR.TX1	white - RC
5576.E27.128.ST.TX1	white - RC

built-up

5577.E27/.. - SHAKE 3 GLASS

~230V IP20 1,5 m 0,5 m 05.20.02 CE



pendant - down - with 3x 1,5m textile cable on Juba base  
 Pendelleuchte - down - mit 3x 1,5m Textilkabel auf Basis Juba

**Lamp type**

3x A60 E27 max. 10,5W **A** - **E** 230V  
 or 3x ST64 E27 max. 40W **A** - **E** 230V

**Dimensions**

L900xB180xH1763 - Cable 1500  
 Base - L900xB50xH40

**Materials**

aluminium 1M | 2M  
 aluminium / red copper 128 | 228  
 brass 16

**Ref**

5577.E27.1M.TR.TX1 white tex  
 5577.E27.1M.ST.TX1 white tex  
 5577.E27.2M.TR.TX2 black tex  
 5577.E27.2M.ST.TX2 black tex  
 5577.E27.16.TR.TXM satin gold  
 5577.E27.16.ST.TXM satin gold  
 5577.E27.116.TR.TX1 white - gold  
 5577.E27.116.ST.TX1 white - gold  
 5577.E27.216.TR.TX2 black - gold  
 5577.E27.216.ST.TX2 black - gold  
 5577.E27.228.TR.TX2 black - RC  
 5577.E27.228.ST.TX2 black - RC  
 5577.E27.128.TR.TX1 white - RC  
 5577.E27.128.ST.TX1 white - RC

built-up

PENDANTS



5578.E27/.. - SHAKE 3 GLASS

~230V IP20 1,5 m 0,5 m 05.20.02 CE



pendant - down - with 3x 1,5m textile cable on base Rondo Box  
 Pendelleuchte - down - mit 3x 1,5m Textilkabel auf Basis Rondo Box

**Lamp type**

3x A60 E27 max. 10,5W **A** - **E** 230V  
 or 3x ST64 E27 max. 40W **A** - **E** 230V

**Dimensions**

Ø350xH1715 - Cable 1500  
 Base - Ø350xH28

**Materials**

aluminium 1M | 2M  
 aluminium / red copper 128 | 228 | MIX28

**Ref cat (LONG)**

5578.E27.1M.TR.TX1 white tex  
 5578.E27.1M.ST.TX1 white tex  
 5578.E27.2M.TR.TX2 black tex  
 5578.E27.2M.ST.TX2 black tex  
 5578.E27.116.TR.TX1 white - gold  
 5578.E27.116.ST.TX1 white - gold  
 5578.E27.216.TR.TX2 black - gold  
 5578.E27.216.ST.TX2 black - gold  
 5578.E27.228.TR.TX2 black - RC  
 5578.E27.228.ST.TX2 black - RC  
 5578.E27.128.TR.TX1 white - RC  
 5578.E27.128.ST.TX1 white - RC  
 5578.E27.MIX16.TR.TX2 mix gold - black  
 5578.E27.MIX28.ST.TX2 mix RC - black

built-up

5579.E27/.. - SHAKE 5 GLASS

~230V LED C IP20 1,5 m 0,5 m 05.20.50 CE



pendant - down - with 5x 1,5m textile cable on base Juba  
 Pendelleuchte - down - mit 5x 1,5m Textilkabel auf Basis Juba

**Lamp type**

3x A60 E27 max. 10,5W **A** - **E** 230V  
 2x LED 630lm CRI90 max. 6W 230V

**Dimensions**

L1600xB180xH1800 - Cable 1500  
 Base - L1600xB50xH40

**Materials**

aluminium 1M | 2M  
 aluminium / red copper 128 | 228 | MIX28

**Ref**

5579.E27.1M.TR.TX1 white tex  
 5579.E27.1M.ST.TX1 white tex  
 5579.E27.2M.TR.TX2 black tex  
 5579.E27.2M.ST.TX2 black tex  
 5579.E27.116.TR.TX1 white - gold  
 5579.E27.116.ST.TX1 white - gold  
 5579.E27.216.TR.TX2 black - gold  
 5579.E27.216.ST.TX2 black - gold  
 5579.E27.228.TR.TX2 black - RC  
 5579.E27.228.ST.TX2 black - RC  
 5579.E27.128.TR.TX1 white - RC  
 5579.E27.128.ST.TX1 white - RC  
 5579.E27.MIX16.TR.TX2 mix gold - black  
 5579.E27.MIX16.ST.TX2 mix gold - black  
 5579.E27.MIX28.TR.TX2 mix RC - black  
 5579.E27.MIX28.ST.TX2 mix RC - black

built-up

5580.LED/.. - SHAKE 3 METAL

~230V  IP20  0,8 m   



pendant with swivel - rod can be shortened - down  
Pendelleuchte mit Kugelgelenk - kürzbare Stange - down

**Lamp type**  
3x LED 630lm CRI90 max. 6W 230V

**Dimensions**  
L1600xB150xH965 - Bar 800  
Base - L450xB60xH30

Ref	
5580.LED.1M	NW   WW
5580.LED.2M	NW   WW
5580.LED.14	NW   WW
5580.LED.116	NW   WW
5580.LED.216	NW   WW
5580.LED.228	NW   WW
5580.LED.128	NW   WW
5580.LED.MIX16	NW   WW
5580.LED.MIX28	NW   WW

built-up

5581.LED/.. - SHAKE 5 METAL

~230V  IP20  0,8 m   



pendant with swivel - rod can be shortened - down  
Pendelleuchte mit Kugelgelenk - kürzbare Stange - down

**Lamp type**  
5x LED 630lm CRI90 max. 6W 230V

**Dimensions**  
L1600xB150xH965 - Bar 800  
L450xB60xH30

Ref	
5581.LED.1M	NW   WW
5581.LED.2M	NW   WW
5581.LED.14	NW   WW
5581.LED.116	NW   WW
5581.LED.216	NW   WW
5581.LED.228	NW   WW
5581.LED.128	NW   WW
5581.LED.MIX16	NW   WW
5581.LED.MIX28	NW   WW

built-up

5582.E27/.. - SHAKE 3 GLASS

~230V  IP20   0,8 m   



pendant with swivel - rod can be shortened - down  
Pendelleuchte mit Kugelgelenk - kürzbare Stange - down

**Lamp type**  
3x A60 E27 max. 60W 230V

**Dimensions**  
L1000xB150xH1002 - Bar 800  
L560xB60xH30  
Glass - Ø150xH112

**Materials**  
aluminium 1M | 2M  
aluminium / red copper 128 | 228

Ref	
5582.E27.1M.TR	white tex
5582.E27.1M.ST	white tex
5582.E27.2M.TR	black tex
5582.E27.2M.ST	black tex
5582.E27.116.TR	white - gold
5582.E27.116.ST	white - gold
5582.E27.216.TR	black - gold
5582.E27.216.ST	black - gold
5582.E27.228.TR	black - RC
5582.E27.228.ST	black - RC
5582.E27.128.TR	white - RC
5582.E27.128.ST	white - RC

built-up

5583.E27/.. - SHAKE 5 GLASS

~230V  IP20   0,8 m   



pendant with swivel - rod can be shortened - down  
Pendelleuchte mit Kugelgelenk - kürzbare Stange - down

**Lamp type**  
5x A60 E27 max. 60W 230V

**Dimensions**  
L1600xB150xH1002 - Bar 800  
Base - L450xB60xH30  
Glass - Ø150xH112

**Materials**  
aluminium 1M | 2M  
aluminium / red copper 128 | 228

Ref	
5583.E27.1M.TR	white tex
5583.E27.1M.ST	white tex
5583.E27.2M.TR	black tex
5583.E27.2M.ST	black tex
5583.E27.116.TR	white - gold
5583.E27.116.ST	white - gold
5583.E27.216.TR	black - gold
5583.E27.216.ST	black - gold
5583.E27.228.TR	black - RC
5583.E27.228.ST	black - RC
5583.E27.128.TR	white - RC
5583.E27.128.ST	white - RC

built-up



5584.E27/.. - SHAKE 3 GLASS

~230V IP20 0,8 m 0,5 m 05.20.02 CE



built-up

pendant with swivel - rod can be shortened - down  
 Pendelleuchte mit Kugelgelenk - kürzbare Stange - down

Lamp type

3x A60 E27 max. 60W **A** - **E** 230V

Dimensions

L1000xB180xH1077 - Bar 800

L450xB60xH30

Glass - Ø180xH187

Materials

aluminium 1M | 2M  
 aluminium / red copper 128 | 228

Ref

5584.E27.1M.TR	white tex
5584.E27.1M.ST	white tex
5584.E27.2M.TR	black tex
5584.E27.2M.ST	black tex
5584.E27.116.TR	white - gold
5584.E27.116.ST	white - gold
5584.E27.216.TR	black - gold
5584.E27.216.ST	black - gold
5584.E27.228.TR	black - RC
5584.E27.228.ST	black - RC
5584.E27.128.TR	white - RC
5584.E27.128.ST	white - RC

5585.E27/.. - SHAKE 5 GLASS

~230V IP20 0,8 m 0,5 m 05.20.02 CE

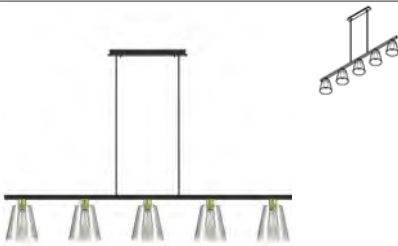

built-up

pendant with swivel - rod can be shortened - down  
 Pendelleuchte mit Kugelgelenk - kürzbare Stange - down

Lamp type

5x A60 E27 max. 60W **A** - **E** 230V

Dimensions

L1600xB180xH1077 - Bar 800

Base - L450xB60xH30

Glass - Ø180xH187

Materials

aluminium 1M | 2M  
 aluminium / red copper 128 | 228

Ref

5585.E27.1M.TR	white tex
5585.E27.1M.ST	white tex
5585.E27.2M.TR	black tex
5585.E27.2M.ST	black tex
5585.E27.116.TR	white - gold
5585.E27.116.ST	white - gold
5585.E27.216.TR	black - gold
5585.E27.216.ST	black - gold
5585.E27.228.TR	black - RC
5585.E27.228.ST	black - RC
5585.E27.128.TR	white - RC
5585.E27.128.ST	white - RC



055B/.. - ROSETTE for textile cable - TX

~230V



IP20



built-up base - with strain relief for 1 textile cable  
 Aufbaurosette - mit Zugentlastung für 1 Textilkabel

**Dimensions**

Ø62xH30

**Materials**

aluminium	14   1M   2M
brass	4   13   16   23
red copper	28

**Ref**

055B.1M	white tex
055B.2M	black tex
055B.4	shiny gold
055B.13	bronze
055B.14	alu satin
055B.16	satin gold
055B.23	dark bronze
055B.28	rosé

built-up

054B/.. - ROSETTE for textile cable - TX

~230V



IP20



built-up base - built-up base with strain relief for 1 textile cable  
 Aufbaurosette - Aufbaurosette mit Zugentlastung für 1 Textilkabel

**Dimensions**

Ø64xH41

**Materials**

aluminium	14   1M   2M
brass	4   13   16   23
red copper	28

**Ref**

054B.1M	white tex
054B.2M	black tex
054B.4	shiny gold
054B.13	bronze
054B.14	alu satin
054B.16	satin gold
054B.23	dark bronze
054B.28	rosé

built-up







3407/.. - CLARA - TX

~230V



pendant - fixed - with 1,5m textile cable and strain relief on lampholder's side  
 Pendelleuchte - fest - mit 1,5m Textilkabel und Zugentlastung an Fassung

Lamp type

1x QPAR 51 GU10 max. 20W **A+** - **E** 230V

Dimensions

Ø75xH140 - Cable 1500

Materials

aluminium 14 | 1M | 29 | 2M | 47  
 red copper 28

Ref

3407.1M.TX1	white tex
3407.2M.TX2	black tex
3407.2M.TX3	black tex
3407.14.TX2	alu satin
3407.28.TX2	rosé
3407.29.TX2	black - gold in
3407.29.TX3	black - gold in
3407.47.TX2	black - white in

built-up

3406/.. - CLARA - TX

~230V

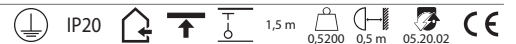

pendant - fixed - with 1,5m textile cable and strain relief on lampholder's side  
 Pendelleuchte - fest - mit 1,5m Textilkabel und Zugentlastung an Fassung

Lamp type

1x D45 E27 max. 40W **A** - **E** 230V

Dimensions

Ø120xH160 - Cable 1500

Materials

aluminium 14 | 1M | 29 | 2M | 47  
 red copper 28 | 52

Ref

3406.1M.TX1	white tex
3406.2M.TX2	black tex
3406.2M.TX3	black tex
3406.14.TX2	alu satin
3406.28.TX2	rosé
3406.29.TX2	black - gold in
3406.29.TX3	black - gold in
3406.47.TX2	black - white in
3406.52.TX2	black out - RC in

built-up

3405/.. - CLARA XICATO - TX

~230V



pendant - fixed - with 1,5m textile cable and strain relief on lampholder's side - with LED driver  
 Pendelleuchte - fest - mit 1,5m Textilkabel und Zugentlastung an Fassung - mit Driver LED

Lamp type

1x Led 965lm CRI80 max. 6,6W **A** - **A+** 500mA

Dimensions

Ø120xH160 38° reflector - Cable 1500  
 Reflector - Ø111

Ref

3405.1M.TX1	NW   WW
3405.2M.TX2	NW   WW
3405.2M.TX3	NW   WW
3405.14.TX2	NW   WW
3405.28.TX2	NW   WW

built-up



3406.AR70/.. - CLARA - TX

~230V IP20 1,5 m 0,3700 0,5 m 05.20.02 CE



pendant - fixed - with 1,5m textile cable and strain relief on lampholder's side  
 Pendelleuchte - fest - mit 1,5m Textilkabel und Zugentlastung an Fassung

Lamp type

1x QPAR70 GU10 max. 7W **A** 230V  
 1x QPAR 51 GU10 max. 8W **A** - **E** 230V

Dimensions

Ø120xH160 - Cable 1500

Materials

aluminium 14 | 1M | 29 | 2M | 47  
 red copper 28 | 52

Ref

3406.AR70.1M.TX1 white tex  
 3406.AR70.2M.TX2 black tex  
 3406.AR70.2M.TX3 black tex  
 3406.AR70.14.TX2 alu satin  
 3406.AR70.28.TX2 rosé  
 3406.AR70.29.TX2 black - gold in  
 3406.AR70.29.TX3 black - gold in  
 3406.AR70.47.TX2 black - white in  
 3406.AR70.52.TX2 black out - RC in

built-up

3411/.. - CLARA - TX

~230V IP20 1,5 m 0,5 05.20.02 CE



pendant - fixed - with 1,5m textile cable and strain relief on lampholder's side  
 Pendelleuchte - fest - mit 1,5m Textilkabel und Zugentlastung an Fassung

Lamp type

1x A60 E27 max. 60W **A** - **E** 230V

Dimensions

Ø205xH265 - Cable 1500

Materials

aluminium 1M | 29 | 2M | 47

Ref

3411.1M.TX1 white tex  
 3411.2M.TX3 black tex  
 3411.29.TX3 black - gold in  
 3411.47.TX2 black - white in

built-up

3404/.. - CLARA - TX

~230V IP20 1,9300 0,5 m 05.20.02 CE



pendant - fixed - with 1,5m textile cable and strain relief on lampholder's side  
 Pendelleuchte - fest - mit 1,5m Textilkabel und Zugentlastung an Fassung

Lamp type

1x A60 E27 max. 60W **A** - **E** 230V

Dimensions

Ø250xH315 - Cable 1500

Materials

aluminium 1M | 29 | 2M | 47

Ref

3404.1M.TX1 white tex  
 3404.2M.TX2 black tex  
 3404.2M.TX3 black tex  
 3404.29.TX2 black - gold in  
 3404.29.TX3 black - gold in  
 3404.47.TX2 black - white in

built-up

033.B3.D8,3/.. - ROZET VOOR PENDEL - B3

III IP20    0,2300 



built-up base for pendant - round - with swivel B3  
 Aufbaubase für Pendelleuchte - rund - mit Kugelgelenk B3

**Dimensions**  
 ↳ Ø60xH40

**Materials**  
 aluminium 14 | 1M | 2M  
 brass 4 | 13 | 23

**Ref**  
 033.B3.D8.3.1M white tex  
 033.B3.D8.3.2M black tex  
 033.B3.D8.3.4 shiny gold  
 033.B3.D8.3.13 bronze  
 033.B3.D8.3.14 alu satin  
 033.B3.D8.3.23 dark bronze

built-up

020.B3/./.. - ROSETTE - M10-M8-M6-D8,3 - B3

III IP20   



built-up base - round - with swivel B3  
 Aufbaurosette - rund - mit Kugelgelenk B3

**Dimensions**  
 ↳ Ø54xH60

**Materials**  
 aluminium 1 | 2 | 11 | 14 | 1M | 2M  
 brass 4 | 13 | 16

Colour	020. B3.D8,3/..	020. B3.M10/..	020. B3.M6/..	020. B3.M8/..
1				
1M				
2				
2M				
4				
11				
13				
14				
16				

built-up  
 for pendants only - not for spots  
 nur für Hängeleuchte - nicht für Aufbaustrahler



3407.B3/.. - CLARA - B3

~230V IP20 0,8 m 0,2500 0,5 m 05.20.02 CE



pendant with swivel - fixed  
Pendelleuchte mit Kugelgelenk - fest

Lamp type

1x QPAR 51 GU10 max. 20W **A+** - **E** 230V

Dimensions

Ø75xH140 - Bar 800

Materials

aluminium 14 | 1M | 29 | 2M | 47  
red copper 28

Ref

3407.B3.1M white tex  
3407.B3.2M black tex  
3407.B3.14 alu satin  
3407.B3.28 rosé  
3407.B3.29 black - gold in  
3407.B3.47 black - white in

built-up

3406.AR70.B3/.. - CLARA - B3

~230V IP20 0,8 m 0,5 m 05.20.02 CE



pendant with swivel - fixed  
Pendelleuchte mit Kugelgelenk - fest

Lamp type

1x QPAR70 GU10 max. 8W **A+** 230V

1x QPAR 51 GU10 max. 8W **A+** - **E** 230V

Dimensions

Ø120xH160 - Bar 800

Materials

aluminium 14 | 1M | 29 | 2M | 47 | 49  
red copper 28 | 52

Ref

3406.AR70.B3.1M white tex  
3406.AR70.B3.2M black tex  
3406.AR70.B3.14 alu satin  
3406.AR70.B3.28 rosé  
3406.AR70.B3.29 black - gold in  
3406.AR70.B3.47 black - white in  
3406.AR70.B3.49 white - gold in  
3406.AR70.B3.52 black out - RC in

built-up

3406.B3/.. - CLARA - B3

~230V IP20 0,8 m 0,5 m 05.20.02 CE



pendant with swivel - fixed  
Pendelleuchte mit Kugelgelenk - fest

Lamp type

1x D45 E27 max. 40W **A+** - **E** 230V

Dimensions

Ø120xH160 - Bar 800

Materials

aluminium 14 | 1M | 29 | 2M | 47 | 49  
red copper 28 | 52

Ref

3406.B3.1M white tex  
3406.B3.2M black tex  
3406.B3.14 alu satin  
3406.B3.28 rosé  
3406.B3.29 black - gold in  
3406.B3.47 black - white in  
3406.B3.49 white - gold in  
3406.B3.52 black out - RC in

built-up

3405.B3/.. - CLARA XICATO - B3

~230V IP20 0,8 m 0,6800 0,5 m 05.20.50 CE



pendant with swivel - fixed - with LED driver  
Pendelleuchte mit Kugelgelenk - fest - mit Driver LED

Lamp type

1x Led 965lm CRI80 max. 6,6W **A+** - **A+** 500mA

Dimensions

Ø120xH160 38° reflector - Bar 800  
Reflector - Ø111

Ref

3405.B3.1M NW | WW  
3405.B3.2M NW | WW  
3405.B3.14 NW | WW  
3405.B3.28 NW | WW

built-up







INDOOR | Ceiling UP | Pendants | CLARA

3411.B3/.. - CLARA - B3

~230V IP20 0,8 m 0,7400 0,5 m 05.20.02 CE



pendant with swivel - fixed  
Pendelleuchte mit Kugelgelenk - fest

Lamp type

1x A60 E27 max. 60W **A** - **E** 230V

Dimensions

Ø205xH265 - Bar 800

Materials

aluminium 1M | 29 | 2M | 47

Ref

3411.B3.1M white tex  
3411.B3.2M black tex  
3411.B3.29 black - gold in  
3411.B3.47 black - white in

built-up

3404.B3/.. - CLARA - B3

~230V IP20 0,8 m 0,5 m 05.20.02 CE



pendant with swivel - fixed  
Pendelleuchte mit Kugelgelenk - fest

Lamp type

1x A60 E27 max. 60W **A** - **E** 230V

Dimensions

Ø250xH315 - Bar 800

Materials

aluminium 1M | 29 | 2M | 47

Ref

3404.B3.1M white tex  
3404.B3.2M black tex  
3404.B3.29 black - gold in  
3404.B3.47 black - white in

built-up



3412.3/.. - CLARA - TX

~230V  IP20   0.5 m  05.20.02 

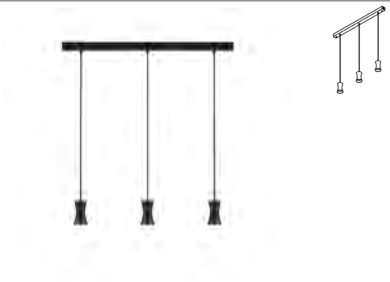

pendant - fixed - with 3x Clara Ø75 on base Juba  
Pendelleuchte - fest - mit 3x Clara Ø75 auf Basis Juba

**Lamp type**  
3x QPAR 51 GU10 max. 20W  -  **230V**

**Dimensions**  
L900xB75xH1685 - Cable 1500  
Base - L900xB45xH45  
Housing - Ø75xH140

**Materials**  
aluminium **1M | 29 | 2M | 49**  
aluminium / red copper **228**

Ref	
3412.3.1M.TX1	white tex
3412.3.2M.TX2	black tex
3412.3.29.TX2	black - gold in
3412.3.49.TX1	white - gold in
3412.3.228.TX2	black - RC
3412.3.228.TXRK	black - RC

built-up

3413.5/.. - CLARA - TX

~230V  IP20   0.5 m  05.20.02 

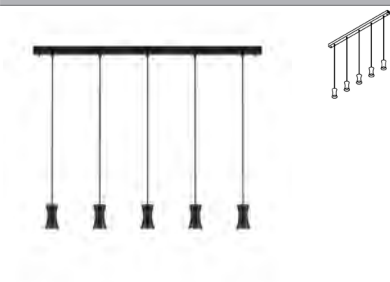

pendant - fixed - with 5x Clara Ø75 on base Juba  
Pendelleuchte - fest - mit 5x Clara Ø75 auf Basis Juba

**Lamp type**  
5x QPAR 51 GU10 max. 20W  -  **230V**

**Dimensions**  
L1200xB75xH1685 - Cable 1500  
Base - L1200xB45xH45  
Cone - Ø75xH140

**Materials**  
aluminium **1M | 29 | 2M | 49**  
aluminium / red copper **228**

Ref	
3413.5.1M.TX1	white tex
3413.5.2M.TX2	black tex
3413.5.29.TX2	black - gold in
3413.5.49.TX1	white - gold in
3413.5.228.TX2	black - RC
3413.5.228.TXRK	black - RC



built-up

3414.3/.. - CLARA - TX

~230V  IP20   0.5 m  05.20.02 



pendant - fixed - with 3x Clara Ø120 on base Juba  
Pendelleuchte - fest - mit 3x Clara Ø120 auf Basis Juba

**Lamp type**  
3x QPAR70 GU10 max. 7W  **230V**  
1x QPAR 51 GU10 max. 8W  -  **230V**

**Dimensions**  
L900xB120xH1705 - Cable 1500  
Base - L900xB45xH45  
Cone - Ø120xH160

**Materials**  
aluminium **1M | 29 | 2M | 49**  
aluminium / red copper **228**

Ref	
3414.3.1M.TX1	white tex
3414.3.2M.TX2	black tex
3414.3.29.TX2	black - gold in
3414.3.49.TX1	white - gold in
3414.3.228.TX2	black - RC
3414.3.228.TXRK	black - RC



built-up

3415.5/.. - CLARA - TX

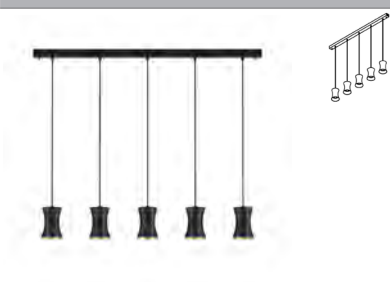
~230V  IP20   0.5 m  05.20.02 



pendant - fixed - with 5x Clara Ø120 on base Juba  
Pendelleuchte - fest - mit 5x Clara Ø120 auf Basis Juba

**Lamp type**  
5x QPAR 51 GU10 max. 20W  -  **230V**  
or 5x QPAR70 GU10 max. 7W  **230V**

**Dimensions**  
L1200xB120xH1705 - Cable 1500  
Base - L1200xB45xH45  
Cone - Ø120xH160

**Materials**  
aluminium **1M | 29 | 2M | 49**  
aluminium / red copper **228**

Ref	
3415.5.1M.TX1	white tex
3415.5.2M.TX2	black tex
3415.5.29.TX2	black - gold in
3415.5.49.TX1	white - gold in
3415.5.228.TX2	black - RC
3415.5.228.TXRK	black - RC

built-up

3416.3/.. - CLARA - TX

~230V  IP20    0,5 m  05.20.02 



pendant - fixed - with 3x Clara Ø205 on base Juba  
Pendelleuchte - fest - mit 3x Clara Ø205 auf Basis Juba

Lamp type

 3x A60 E27 max. 60W  -  230V

Dimensions

 L1200xB120xH1810 - Cable 1500

Base - L1200xB45xH45

Cone - Ø205xH265

Materials

aluminium 1M | 29 | 2M | 49

Ref

3416.3.1M.TX1	white tex
3416.3.2M.TX2	black tex
3416.3.29.TX2	black - gold in
3416.3.49.TX1	white - gold in

built-up

3417.3/.. - CLARA - TX

~230V  IP20    0,5 m  05.20.02 



pendant - fixed - with 3x Clara Ø205 on base Juba  
Pendelleuchte - fest - mit 3x Clara Ø205 auf Basis Juba

Lamp type

 3x A60 E27 max. 60W  -  230V

Dimensions

 L1200xB120xH1860 - Cable 1500

Base - L1200xB45xH45

Cone - Ø250xH315

Materials

aluminium 1M | 29 | 2M | 49

Ref

3417.3.1M.TX1	white tex
3417.3.2M.TX2	black tex
3417.3.29.TX2	black - gold in
3417.3.49.TX1	white - gold in

built-up

3418.5/.. - CLARA - TX

~230V  IP20    0,5 m  05.20.02 



pendant - fixed - with 3x Clara Ø120 and 2x Clara Ø205 on base Rondobox  
Pendelleuchte - fest - mit 3x Clara Ø120 und 2x Clara Ø205 auf Basis Rondobox

Lamp type

 2x A60 E27 max. 60W  -  230V

 3x QPAR 51 GU10 max. 11W  -  230V

Dimensions

 Ø400xH1793 - Cable 1500

Cone - Ø205xH265

Base - Ø400xH28

Materials

aluminium 1M | 29 | 2M | 49

Ref

3418.5.1M.TX1	white tex
3418.5.2M.TX2	black tex
3418.5.29.TX2	black - gold in
3418.5.49.TX1	white - gold in

built-up

# INDOOR | Ceiling UP | Pendants | CAPA - TONDO

All M10 spotlights and pendants can be combined with bases (built-in & built-up) and Juba bases as preferred.

Alle M10 Aufbaustrahler und Pendelleuchten können mit Rosetten (In- & Aufbau) und Juba Basen nach Wahl kombiniert werden.

## 7701.B3/.. - CAPA - B3

~230V



IP20



0,8 m



0,1500



1 m



05.20.02



pendant with swivel - rod can be shortened  
Pendelleuchte mit Kugelgelenk - kürzbare Stange

### Lamptype

1x QPAR 51 GU10 max. 20W A+ - E 230V

### Dimensions

Ø32xH40 - Bar 800

### Materials

aluminium 14 | 1M | 2M | 11M

### Ref

7701.B3.1M	white tex
7701.B3.2M	black tex
7701.B3.11M	grey tex
7701.B3.14	alu satin

built-up

## 5051.B3/.. - CAPA X - B3

~230V



IP20



0,8 m



0,5 m



05.20.02



pendant with swivel - rod can be shortened  
Pendelleuchte mit Kugelgelenk - kürzbare Stange

### Lamptype

1x QPAR 51 GU10 max. 20W A+ - E 230V

### Dimensions

Ø54xH84 - Bar 800

### Materials

aluminium 1M | 2M | 46

### Ref

5051.B3.1M	white tex
5051.B3.2M	black tex
5051.B3.46	grey-brown

built-up

## 5051.M10/.. - CAPA X - M10

~230V



IP20



0,8 m



0,5 m



05.20.02



pendant with swivel - rod can be shortened  
Pendelleuchte mit Kugelgelenk - kürzbare Stange

### Lamptype

1x QPAR 51 GU10 max. 20W A+ - E 230V

### Dimensions

Ø54xH84 - 800

### Materials

aluminium 1M | 2M | 46

### Ref

5051.M10.1M	white tex
5051.M10.2M	black tex
5051.M10.46	grey-brown

built-up

## 5052/.. - TONDO - B3

~230V



IP20



0,8 m



0,5 m



05.20.02



pendant with swivel - rod can be shortened  
Pendelleuchte mit Kugelgelenk - kürzbare Stange

### Lamptype

1x QPAR 51 GU10 max. 20W A+ - E 230V

### Dimensions

Ø75xH97 - Bar 800

### Materials

aluminium 1M | 2M | 46

### Ref

5052.1M	white tex
5052.2M	black tex
5052.46	grey-brown

built-up







1423/.. - TALLY - B3

~230V   IP20   0,8 m   



pendant with swivel - fixed - down - with LED driver  
 Pendelleuchte mit Kugelgelenk - fest - down - mit Driver LED

**Lamp type**  
 3x led 467lm CRI80 max. 3,8W  -  350mA

**Dimensions**  
 L450xB45xH910  48 - Bar 800  
 L400xB40xH40

Ref	
1423.2M	NW   WW
1423.29	NW   WW
1423.47	NW   WW
1423.1M.16	NW   WW
1423.2M.16	NW   WW



built-up



1425/.. - TALLY - B3

~230V   IP20   0,8 m   



pendant with swivel - fixed - down - with LED driver  
 Pendelleuchte mit Kugelgelenk - fest - down - mit Driver LED

**Lamp type**  
 5x led 467lm CRI80 max. 3,8W  -  350mA

**Dimensions**  
 L790xB45xH910  48 - Bar 800  
 L400xB40xH40

Ref	
1425.2M	NW   WW
1425.29	NW   WW
1425.47	NW   WW
1425.1M.16	NW   WW
1425.2M.16	NW   WW



built-up



1427/.. - TALLY - B3

~230V   IP20   0,8 m   



pendant with swivel - fixed - down - with LED driver  
 Pendelleuchte mit Kugelgelenk - fest - down - mit Driver LED

**Lamp type**  
 7x led 467lm CRI80 max. 3,8W  -  350mA

**Dimensions**  
 L1130xB45xH910  48 - Bar 800  
 L400xB40xH40

Ref	
1427.2M	NW   WW
1427.29	NW   WW
1427.47	NW   WW
1427.1M.16	NW   WW
1427.2M.16	NW   WW

built-up



1350/.. - TALLY - B3

~230V



pendant with swivel - fixed - down/up - with LED driver  
 Pendelleuchte mit Kugelgelenk - fest - down/up - mit Driver LED

Lamp type

6x led 467lm CRI80 max. 3,8W A+ - A+ 350mA

Dimensions

L1130xB45xH910  $\wedge$  48 - Bar 800  
 L400xB40xH40

Ref

1350.2M	NW   WW
1350.29	NW   WW
1350.47	NW   WW
1350.1M.16	NW   WW
1350.2M.16	NW   WW

built-up

1353/.. - TALLY - TX

=350mA



suspension with textile cable - fixed - down/up - without LED driver  
 pendelleuchte mit Textilkabel - fest - down/up - ohne Driver LED

Lamp type

5x led 467lm CRI80 max. 3,8W A+ - A+ 350mA

Dimensions

L790xB60xH715  $\wedge$  48 - Cable 1000  
 Base - Ø60xH25

Ref

1353.1M.16.TX2	TX2   TX2
1353.2M.16.TX2	TX2   TX2
1353.2M.TX2	NW   WW
1353.29.TX2	NW   WW
1353.47.TX2	NW   WW

built-up



4026.B3/.. - GUILIA A - B3

~12V



pendant with swivel - rod can be shortened - without transformer  
 Pendelleuchte mit Kugelgelenk - kürzbare Stange - ohne Trafo

Lamp type

1x QT12 GY6,35 max. 35W - 12V  
 or 1x QT9-ax G4 max. 20W - 12V

Dimensions

Ø60xH800 - Bar 800  
 Glass - Ø60xH120

Materials

aluminium 14 | 1M | 2M  
 brass 16 | 23

Ref

4026.B3.1M white tex  
 4026.B3.2M black tex  
 4026.B3.14 alu satin  
 4026.B3.16 satin gold  
 4026.B3.23 dark bronze

built-up

4026.G9.B3/.. - GUILIA A - G9 - B3

~230V



pendant with swivel - rod can be shortened  
 Pendelleuchte mit Kugelgelenk - kürzbare Stange

Lamp type

1x QT14 G9 max. 25W - 230V

Dimensions

Ø60xH800 - 800  
 Glass - Ø60xH120

Materials

aluminium 14 | 1M | 2M  
 brass 16 | 23

Ref

4026.G9.B3.1M white tex  
 4026.G9.B3.2M black tex  
 4026.G9.B3.14 alu satin  
 4026.G9.B3.16 satin gold  
 4026.G9.B3.23 dark bronze

built-up

R1029/.. - GUILIA A spare glass

IP20



spare glass  
 Ersatzglas  
 Glass - Ø60xH120

Ref

R1029

rod not included  
 Stange nicht einbegriffen



PENDANTS

4027.B3/.. - GUILIA B - B3

~12V 0,8 m



pendant with swivel - rod can be shortened - without transformer  
 Pendelleuchte mit Kugelgelenk - kürzbare Stange - ohne Trafo

**Lamp type**

1x QT12 GY6,35 max. 35W - 12V

**Dimensions**

Ø60xH800 - Bar 800

Glass - Ø60xH120

**Materials**

aluminium 14 | 1M | 2M  
 brass 16 | 23

**Ref**

4027.B3.1M white tex  
 4027.B3.2M black tex  
 4027.B3.14 alu satin  
 4027.B3.16 satin gold  
 4027.B3.23 dark bronze

built-up

4027.G9.B3/.. - GUILIA B - G9 - B3

~230V IP20 0,8 m



pendant with swivel - rod can be shortened  
 Pendelleuchte mit Kugelgelenk - kürzbare Stange

**Lamp type**

1x QT14 G9 max. 25W - 230V

**Dimensions**

Ø60xH800 - 800

Glass - Ø60xH120

**Materials**

aluminium 14 | 1M | 2M  
 brass 16 | 23

**Ref**

4027.G9.B3.1M white tex  
 4027.G9.B3.2M black tex  
 4027.G9.B3.14 alu satin  
 4027.G9.B3.16 satin gold  
 4027.G9.B3.23 dark bronze

built-up

R1028/.. - GUILIA B spare glass

IP20



spare glass  
 Ersatzglas  
 Glass - Ø60xH120

**Ref**

R1028

rod not included  
 Stange nicht einbegriffen

GL2718CG/.. - GUILIA C spare glass

IP20



spare glass - ceramic grey  
 Ersatzglas - Grau keramisches  
 Glass - Ø106xH110

**Ref**

GL2718CG

rod not included  
 Stange nicht einbegriffen



4028.B3/.. - GUILIA C - B3

~12V



pendant with swivel - rod can be shortened - glass GL2718CG white-grey included - without transformer  
 Pendelleuchte mit Kugelgelenk - kürzbare Stange - Glas GL2718CG Kreide-Weiß einbegriffen - ohne Trafo

Ref  
 4028.B3.14 alu satin

**Lamp type**  
 1x QT12 GY6,35 max. 50W - 12V

**Dimensions**  
 Ø106xH800 - Bar 800  
 Glass - Ø106xH110

**Materials**  
 aluminium 14

built-up

4028.G9.B3/.. - GUILIA C - G9 - B3

~230V IP20



pendant with swivel - rod can be shortened  
 Pendelleuchte mit Kugelgelenk - kürzbare Stange

Ref  
 4028.G9.B3.14 alu satin

**Lamp type**  
 1x QT14 G9 max. 25W - 230V

**Dimensions**  
 Ø106xH800 - Bar 800  
 Glass - Ø106xH110

**Materials**  
 aluminium 14

built-up

4028X.B3/.. - GUILIA C - B3

~230V IP20



pendant with swivel - rod can be shortened - glass black/gold included  
 Pendelleuchte mit Kugelgelenk - kürzbare Stange - Glass Schwarz/Gold einbegriffen

Ref  
 4028X.B3.2M black tex  
 4028X.B3.14 alu satin

**Lamp type**  
 1x QT14 G9 max. 20W - 230V

**Dimensions**  
 Ø106xH800 - Bar 800  
 Glass - Ø106xH110

**Materials**  
 aluminium 14 | 2M

built-up

4028XLED.B3/.. - GUILIA C - B3

~230V IP20



pendant with swivel - rod can be shortened - glass black/gold included  
 Pendelleuchte mit Kugelgelenk - kürzbare Stange - Glass Schwarz/Gold einbegriffen

Ref  
 4028XLED.B3.2M.WW black tex  
 4028XLED.B3.14.WW alu satin

**Lamp type**  
 1x Led 550lm CRI80 max. 5W 230V

**Dimensions**  
 Ø106xH800 - 800  
 Glass - Ø106xH110

**Materials**  
 aluminium 14 | 2M

built-up

4004.B3/.. - LUNA - B3

~12V IP20 0,8 m 0,7830 0,5 m



pendant with swivel - rod can be shortened - without transformer  
 Pendelleuchte mit Kugelgelenk - kürzbare Stange - ohne Trafo

**Lamp type**

1x QR-CB 51 GU5,3/GX5,3 max. 35W - 12V

**Dimensions**

Ø60xH92 - Bar 800

4mm glass - Glas

Glass - Ø130

**Materials**

aluminium 1 | 2 | 11 | 14

brass 4 | 13 | 16

**Ref**

4004.B3.1	white
4004.B3.2	black
4004.B3.4	shiny gold
4004.B3.11	alu grey
4004.B3.13	bronze
4004.B3.14	alu satin
4004.B3.16	satin gold

*built-up  
 use coolfit lamp  
 Coolfit-Lampe verwenden*

4000.01/.. - LUNA spare glass

IP20 0,1000

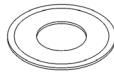

spare glass - sandblasted white glass  
 Ersatzglas - weiß sandgestrahltes Glas

**Dimensions**

Ø130

4mm glass - Glas

Inside glass - Ø58

**Ref**

4000.01



4013.B3/.. - NOA PC - B3

~12V   IP20     0,52 m    



pendant with swivel - rod can be shortened - without transformer  
 Pendelleuchte mit Kugelgelenk - kürzbare Stange - ohne Trafo

Ref	
4013.B3.1M	white tex
4013.B3.2M	black tex
4013.B3.14	alu satin
4013.B3.16	satin gold

**Lamp type**  
 1x QR-CB 51 GU5,3/GX5,3 max. 50W  -  12V

**Dimensions**  
 Ø60xH250 - Bar 520

**Materials**  
 aluminium 14 | 1M | 2M  
 brass 16

built-up  
 use coolfit lamp  
 Coolfit-Lampe verwenden

4013.ES50.B3/.. - NOA PC - B3

~230V  IP20     0,52 m    



pendant with swivel - rod can be shortened  
 Pendelleuchte mit Kugelgelenk - kürzbare Stange

Ref	
4013.ES50.B3.1M	white tex
4013.ES50.B3.2M	black tex
4013.ES50.B3.14	alu satin
4013.ES50.B3.16	satin gold

**Lamp type**  
 1x QPAR 51 GU10 max. 20W  -  230V

**Dimensions**  
 Ø60xH250 - Bar 520

**Materials**  
 aluminium 1M | 2M  
 brass 16

built-up  
 use coolfit lamp  
 Coolfit-Lampe verwenden



4014.B3/.. - NOA glass + alu - B3

~12V  IP20     0,52 m    



pendant with swivel - rod can be shortened - without transformer  
 Pendelleuchte mit Kugelgelenk - kürzbare Stange - ohne Trafo

Ref	
4014.B3.1M	white tex
4014.B3.2M	black tex
4014.B3.14	alu satin
4014.B3.16	satin gold

**Lamp type**  
 1x QR-CB 51 GU5,3/GX5,3 max. 50W  -  12V

**Dimensions**  
 Ø60xH250 - Bar 520

**Materials**  
 aluminium 14 | 1M | 2M  
 brass 16

built-up  
 use coolfit lamp  
 Coolfit-Lampe verwenden

4014.ES50.B3/.. - NOA - B3

~230V  IP20     0,52 m    



pendant with swivel - rod can be shortened - without transformer  
 Pendelleuchte mit Kugelgelenk - kürzbare Stange - ohne Trafo

Ref	
4014.ES50.B3.1M	white tex
4014.ES50.B3.2M	black tex
4014.ES50.B3.14	alu satin
4014.ES50.B3.16	satin gold

**Lamp type**  
 1x QPAR 51 GU10 max. 20W  -  230V

**Dimensions**  
 Ø60xH250 - Bar 520

**Materials**  
 aluminium 14 | 1M | 2M  
 brass 16

built-up  
 use coolfit lamp  
 Coolfit-Lampe verwenden

4015.B3/.. - NOA alu - B3

~12V IP20 0,52 m 0,5210 0,5 m 05.20.02



pendant with swivel - rod can be shortened - without transformer  
 Pendelleuchte mit Kugelgelenk - kürzbare Stange - ohne Trafo

Ref	
4015.B3.1M	white tex
4015.B3.2M	black tex
4015.B3.14	alu satin

**Lamp type**  
 1x QR-CB 51 GU5,3/GX5,3 max. 50W - 12V

**Dimensions**  
 Ø60xH250 - Bar 520

**Materials**  
 aluminium 14 | 1M | 2M

*built-up*  
 use coolfit lamp  
 Coolfit-Lampe verwenden

4015.ES50.B3/.. - NOA ES50 - B3

~230V IP20 0,52 m 0,3770 0,5 m 05.20.02



pendant with swivel - rod can be shortened  
 Pendelleuchte mit Kugelgelenk - kürzbare Stange

Ref	
4015.ES50.B3.1M	white tex
4015.ES50.B3.2M	black tex
4015.ES50.B3.14	alu satin

**Lamp type**  
 1x QPAR 51 GU10 max. 20W - 230V

**Dimensions**  
 Ø60xH250 - Bar 520

**Materials**  
 aluminium 14 | 1M | 2M

*built-up*  
 use coolfit lamp  
 Coolfit-Lampe verwenden

4016.B3/.. - NOA alu - B3

~12V IP20 0,52 m 0,3770 0,5 m 05.20.02



pendant with swivel - rod can be shortened - without transformer  
 Pendelleuchte mit Kugelgelenk - kürzbare Stange - ohne Trafo

Ref	
4016.B3.1M	white tex
4016.B3.2M	black tex
4016.B3.14	alu satin

**Lamp type**  
 1x QR-CB 51 GU5,3/GX5,3 max. 50W - 12V

**Dimensions**  
 Ø60xH150 - Bar 520

**Materials**  
 aluminium 14 | 1M | 2M

*built-up*  
 use coolfit lamp  
 Coolfit-Lampe verwenden

4016.ES50.B3/.. - NOA ES50 - B3

~230V IP20 0,52 m 0,3770 0,5 m 05.20.02

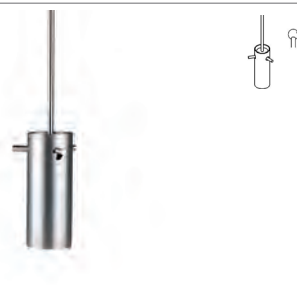

pendant with swivel - rod can be shortened  
 Pendelleuchte mit Kugelgelenk - kürzbare Stange

Ref	
4016.ES50.B3.1M	white tex
4016.ES50.B3.2M	black tex
4016.ES50.B3.14	alu satin

**Lamp type**  
 1x QPAR 51 GU10 max. 20W - 230V

**Dimensions**  
 Ø60xH150 - Bar 520

**Materials**  
 aluminium 14 | 1M | 2M

*built-up*  
 use coolfit lamp  
 Coolfit-Lampe verwenden



3902/.. - NOA large - B3

~230V IP20       0,6 m   



pendant with swivel - rod can be shortened - opal glass cylinder  
 Pendelleuchte mit Kugelgelenk - kürzbare Stange - Opalglas Zylinder

Ref	
3902.1M	white tex
3902.2M	black tex
3902.14	alu satin

**Lamp type**  
 1x TC-SEI E27 max. 15W  -  230V

**Dimensions**  
 Ø100xH400 - Bar 600

**Materials**  
 aluminium 14 | 1M | 2M

built-up  
 other lengths on request  
 andere Längen auf Anfrage

3903/.. - NOA large - B3

~230V IP20       0,6 m   



pendant with swivel - rod can be shortened - opal glass cylinder  
 Pendelleuchte mit Kugelgelenk - kürzbare Stange - Opalglas Zylinder

Ref	
3903.1M	white tex
3903.2M	black tex
3903.14	alu satin

**Lamp type**  
 1x TC-SEI E27 max. 15W  -  230V

**Dimensions**  
 Ø100xH500 - Bar 600

**Materials**  
 aluminium 14 | 1M | 2M

built-up  
 other lengths on request  
 andere Längen auf Anfrage

3904/.. - NOA LARGE - B3

~230V IP20       0,5 m   



pendant with swivel - rod can be shortened - opal glass cylinder  
 Pendelleuchte mit Kugelgelenk - kürzbare Stange - Opalglas Zylinder

Ref	
3904.1M	white tex
3904.2M	black tex
3904.14	alu satin

**Lamp type**  
 1x TC-SEI E27 max. 15W  -  230V

**Dimensions**  
 Ø100xH600 - Bar 500

**Materials**  
 aluminium 14 | 1M | 2M

built-up  
 other lengths on request  
 andere Längen auf Anfrage

3905/.. - NOA LARGE TRIO - B3

~230V IP20       0,8 m   



pendant - opal glass cylinder  
 Pendelleuchte - Opalglas Zylinder

Ref	
3905.1M	white tex
3905.2M	black tex
3905.14	alu satin

**Lamp type**  
 3x TC-SEI E27 max. 15W  -  230V

**Dimensions**  
 Ø250xH1230 - Bar 400/600/800  
 Ø220xH  
 Glass - Ø100xH400

**Materials**  
 aluminium 14 | 1M | 2M

built-up  
 other lengths on request  
 andere Längen auf Anfrage

Metal dome covered with gold leaf on the inside. Other dimensions on request.

Metalkuppel mit Blattgold innen. Andere Abmessungen auf Anfrage.

1519/.. - HANGOVER

~230V



IP20



1,5 m



0,5 m



pendant - with 1,5m textile cable and strain relief on lampholder's side  
 Pendelleuchte - mit 1,5m Textilkabel und Zugentlastung an Fassung

Lamp type

1x A60 E27 max. 10,5W A - E 230V

Dimensions

Ø340xH200 - Cable 1500

Materials

aluminium 1M | 2M

Ref

1519.1M.1M.TX1	white tex
1519.1M.90.TX1	white tex
1519.2M.2M.TX2	black tex
1519.2M.90.TX2	black tex

built-up

1523/.. - HANGOVER

~230V



IP20



1,5 m



0,5 m



pendant - with 1,5m textile cable and strain relief on lampholder's side  
 Pendelleuchte - mit 1,5m Textilkabel und Zugentlastung an Fassung

Lamp type

1x A60 E27 max. 10,5W A - E 230V

Dimensions

Ø500xH250 - Cable 1500

Materials

aluminium 1M | 2M

Ref

1523.1M.1M.TX1	white tex
1523.1M.90.TX1	white tex
1523.2M.2M.TX2	black tex
1523.2M.90.TX2	black tex

built-up

1525/.. - HANGOVER

~230V



IP20



1,5 m



0,5 m

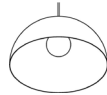

pendant - with 1,5m textile cable and strain relief on lampholder's side  
 Pendelleuchte - mit 1,5m Textilkabel und Zugentlastung an Fassung

Lamp type

1x A60 E27 max. 10,5W A - E 230V

Dimensions

Ø700xH350 - Cable 1500

Materials

aluminium 1M | 2M

Ref

1525.1M.TX1	white tex
1525.1M.90.TX1	white tex
1525.2M.TX2	black tex
1525.2M.90.TX2	black tex

built-up



1487/.. - NOTRE DAME

~230V   IP20    1,5 m  5,2100  0,5m  



pendant with height controller - with electronic gear  
Pendelleuchte mit Höheregler - mit elektronischem Vorschaltgerät

Lamp type

○ 1x TL16-R 2GX13 max. 55W  -  230V

Dimensions

↔ Ø510xH250 - Cable 1500

↻ Ø75

Materials

aluminium 14 | 1M | 2M | 46

Ref

1487.1M	white tex
1487.2M	black tex
1487.14	alu satin
1487.46	grey-brown

built-up

1487.LED/.. - NOTRE DAME LED

~230V    IP20    1,5 m  5,4000  0,5m  



pendant with height controller - with LED driver  
Pendelleuchte mit Höheregler - mit Driver LED

Lamp type

⚡ 1x Led 1800lm max. 13W  700mA

Dimensions

↔ Ø510xH250

↻ Ø75

Materials

aluminium 14 | 1M | 2M | 46

Ref

1487.LED.1M.NW	white tex
1487.LED.2M.NW	black tex
1487.LED.14.NW	alu satin
1487.LED.46.NW	grey-brown

built-up  
Dimmable phase cut  
Dimmbar Phasenabschnitt

1488/.. - NOTRE DAME

~230V    IP20    1,5 m  5,4000  0,5m  



pendant with height controller - with transformer - with electronic gear  
Pendelleuchte mit Höheregler - mit Trafo - mit elektronischem Vorschaltgerät

Lamp type

○ 1x TL16-R 2GX13 max. 55W  -  230V

⚡ 1x QR-LP111 G53 max. 50W  -  12V

Dimensions

↔ Ø510xH250

↻ Ø75

Materials

aluminium 14 | 1M | 2M

Ref

1488.1M	white tex
1488.2M	black tex
1488.14	alu satin

built-up

1488.LED/.. - NOTRE DAME LED



~230V    IP20    1,5 m  5,4000  0,5m  



pendant with height controller - with LED driver  
Pendelleuchte mit Höheregler - mit Driver LED

Lamp type

⚡ 1x Led 1800lm max. 13W  700mA

⚡ 1x QR-LP111 G53 max. 12W  -  12V

Dimensions

↔ Ø510xH250

↻ Ø75

Materials

aluminium 14 | 1M | 2M | 46

Ref

1488.LED.1M.NW	white tex
1488.LED.2M.NW	black tex
1488.LED.14.NW	alu satin
1488.LED.46.NW	grey-brown

built-up  
Dimmable phase cut  
Dimmbar Phasenabschnitt

1394/.. - CAKE

~230V



IP20



1,5 m



0,5 m



pendant - with 1,5m textile cable and strain relief on lampholder's side  
 Pendelleuchte - mit 1,5m Textilkabel und Zugentlastung an Fassung

Lamp type

1x A60 E27 max. 10,5W A - E 230V

Dimensions

Ø200xH100 - Cable 1500

Materials

aluminium 1M | 29 | 2M | 47

Ref

1394.1M	white tex
1394.2M	black tex
1394.29	black - gold in
1394.47	black - white in

built-up

1395/.. - CAKE

~230V



IP20



1,5 m



0,5 m



pendant - with 1,5m textile cable and strain relief on lampholder's side  
 Pendelleuchte - mit 1,5m Textilkabel und Zugentlastung an Fassung

Lamp type

1x A60 E27 max. 10,5W A - E 230V

Dimensions

Ø300xH150 - Cable 1500

Materials

aluminium 1M | 29 | 2M | 47

Ref

1395.1M	white tex
1395.2M	black tex
1395.29	black - gold in
1395.47	black - white in

built-up

1396/.. - CAKE

~230V



IP20



1,5 m



0,5 m



pendant - with 1,5m textile cable and strain relief on lampholder's side  
 Pendelleuchte - mit 1,5m Textilkabel und Zugentlastung an Fassung

Lamp type

1x A60 E27 max. 10,5W A - E 230V

Dimensions

Ø400xH200 - Cable 1500

Materials

aluminium 1M | 29 | 2M | 47

Ref

1396.1M	white tex
1396.2M	black tex
1396.29	black - gold in
1396.47	black - white in

built-up

1489/.. - ROCKY

~230V



IP20



1,5 m



0,5 m



pendant - with 1,5m textile cable and strain relief on lampholder's side  
 Pendelleuchte - mit 1,5m Textilkabel und Zugentlastung an Fassung

Lamp type

1x A60 E27 max. 10,5W A - E 230V

Dimensions

Ø260xH225 - Cable 1500

Materials

aluminium 1M | 29 | 2M | 47

Ref

1489.1M	white tex
1489.2M	black tex
1489.29	black - gold in
1489.47	black - white in

built-up



1397/.. - ROCKY

~230V



IP20



1,5 m



0,5 m



05.20.02



pendant - with 1,5m textile cable and strain relief on lampholder's side  
 Pendelleuchte - mit 1,5m Textilkabel und Zugentlastung an Fassung

Lamp type

1x A60 E27 max. 10,5W A - E 230V

Dimensions

Ø200xH100 - Cable 1500

Materials

aluminium 1M | 29 | 2M | 47

Ref

1397.1M	white tex
1397.2M	black tex
1397.29	black - gold in
1397.47	black - white in

built-up

1398/.. - ROCKY

~230V



IP20



1,5 m



0,5 m



05.20.02



pendant - with 1,5m textile cable and strain relief on lampholder's side  
 Pendelleuchte - mit 1,5m Textilkabel und Zugentlastung an Fassung

Lamp type

1x A60 E27 max. 10,5W A - E 230V

Dimensions

Ø300xH150 - Cable 1500

Materials

aluminium 1M | 29 | 2M | 47

Ref

1398.1M	white tex
1398.2M	black tex
1398.29	black - gold in
1398.47	black - white in

built-up

1399/.. - ROCKY

~230V



IP20



1,5 m



0,5 m



05.20.02



pendant - with 1,5m textile cable and strain relief on lampholder's side  
 Pendelleuchte - mit 1,5m Textilkabel und Zugentlastung an Fassung

Lamp type

1x A60 E27 max. 10,5W A - E 230V

Dimensions

Ø400xH200 - Cable 1500

Materials

aluminium 1M | 29 | 2M | 47

Ref

1399.1M	white tex
1399.2M	black tex
1399.29	black - gold in
1399.47	black - white in

built-up

1422/.. - ROCKY

~230V



IP20



1,5 m



0,5 m



05.20.02



pendant - with 1,5m textile cable and strain relief on lampholder's side  
 Pendelleuchte - mit 1,5m Textilkabel und Zugentlastung an Fassung

Lamp type

1x A60 E27 max. 10,5W A - E 230V

Dimensions

Ø500xH250 - Cable 1500

Materials

aluminium 1M | 29 | 2M | 47

Ref

1422.1M	white tex
1422.2M	black tex
1422.29	black - gold in
1422.47	black - white in

built-up

3500/.. - CIMBALO

~230V IP20 1,5 m 1,0000 0,5 m 05.20.02 CE



suspension with textile cable - with built-up base  
pendelleuchte mit Textilkabel

Lamp type

1x A60 E27 max. 40W **A** - **E** 230V

Dimensions

Ø260xH1700 - Cable 1500  
Ø60

Materials

aluminium 14 | 1M | 2M  
red copper 28

Ref cat (LONG)

3500.1M.TX1	white tex
3500.2M.TX2	black tex
3500.14.CT	alu satin
3500.28.TX2	rosé
3500.28.TX8	rosé

built-up

3501/.. - CIMBALO

~230V IP20 1,5 m 1,0000 0,5 m 05.20.02 CE



suspension with textile cable - with built-up base  
pendelleuchte mit Textilkabel

Lamp type

1x A60 E27 max. 40W **A** - **E** 230V

Dimensions

Ø315xH1700 - Cable 1500  
Ø60

Materials

aluminium 14 | 1M | 2M  
red copper 28

Ref cat (LONG)

3501.1M.TX1	white tex
3501.2M.TX2	black tex
3501.14.CT	alu satin
3501.28.TX2	rosé
3501.28.TX8	rosé

built-up

3502/.. - CIMBALO

~230V IP20 1,5 m 1,0000 0,5 m 05.20.02 CE



suspension with textile cable - with built-up base  
pendelleuchte mit Textilkabel

Lamp type

1x A60 E27 max. 40W **A** - **E** 230V

Dimensions

Ø315xH1650 - Cable 1500  
Ø60

Materials

aluminium 14 | 1M | 2M  
red copper 28

Ref cat (LONG)

3502.1M.TX1	white tex
3502.2M.TX2	black tex
3502.14.CT	alu satin
3502.28.TX2	rosé
3502.28.TX8	rosé

built-up

3500.B3/.. - CIMBALO - B3

~230V IP20 0,8 m 0,5 m 05.20.02 CE



pendant with swivel - rod can be shortened - with built-up base  
 Pendelleuchte mit Kugelgelenk - kürzbare Stange

**Lamp type**  
 1x A60 E27 max. 40W **A** - **E** 230V

**Dimensions**  
 Ø260xH1000 - Bar 800  
 Ø60

**Materials**  
 aluminium 14 | 1M | 2M  
 red copper 28

Ref	
3500.B3.1M	white tex
3500.B3.2M	black tex
3500.B3.14	alu satin
3500.B3.28.2M	rosé

built-up

3501.B3/.. - CIMBALO - B3

~230V IP20 0,8 m 0,5 m 05.20.02 CE



pendant with swivel - rod can be shortened - with built-up base  
 Pendelleuchte mit Kugelgelenk - kürzbare Stange

**Lamp type**  
 1x A60 E27 max. 40W **A** - **E** 230V

**Dimensions**  
 Ø315xH980 - Bar 800  
 Ø60

**Materials**  
 aluminium 14 | 1M | 2M  
 red copper 28

Ref	
3501.B3.1M	white tex
3501.B3.2M	black tex
3501.B3.14	alu satin
3501.B3.28.2M	rosé

built-up

3502.B3/.. - CIMBALO - B3

~230V IP20 0,8 m 0,5 m 05.20.02 CE



pendant with swivel - rod can be shortened - with built-up base  
 Pendelleuchte mit Kugelgelenk - kürzbare Stange

**Lamp type**  
 1x A60 E27 max. 40W **A** - **E** 230V

**Dimensions**  
 Ø315xH940 - Bar 800

**Materials**  
 aluminium 14 | 1M | 2M  
 red copper 28

Ref	
3502.B3.1M	white tex
3502.B3.2M	black tex
3502.B3.14	alu satin
3502.B3.28.2M	rosé

built-up

PENDANTS





1917.TX.ES50/.. - OLIVIA MINI - TX

~230V

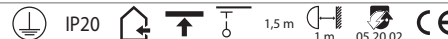

pendant - with 1,5m textile cable and strain relief on lampholder's side  
 Pendelleuchte - mit 1,5m Textilkabel und Zugentlastung an Fassung

**Lamptype**

1x QPAR 51 GU10 max. 20W **A+** - **E** 230V

**Dimensions**

Ø100 - Cable 1500

**Materials**

aluminium 14 | 1M | 29 | 2M  
 brass 13 | 23

**Ref**

- 1917.TX.ES50.1M.TX1 white tex
- 1917.TX.ES50.2M.TX2 black tex
- 1917.TX.ES50.13.TX13 bronze
- 1917.TX.ES50.14.TX11 alu satin
- 1917.TX.ES50.23.TX23 dark bronze
- 1917.TX.ES50.29.TX2 black - gold in

built-up

1917.TX.E27/.. - OLIVIA MINI - TX

~230V



pendant - with 1,5m textile cable and strain relief on lampholder's side  
 Pendelleuchte - mit 1,5m Textilkabel und Zugentlastung an Fassung

**Lamptype**

1x D45 E27 max. 5W **A+** - **E** 230V

**Dimensions**

Ø100 - Cable 1500

**Materials**

aluminium 14 | 1M | 29 | 2M  
 brass 13 | 23

**Ref**

- 1917.TX.E27.1M.TX1 white tex
- 1917.TX.E27.2M.TX2 black tex
- 1917.TX.E27.13.TX13 bronze
- 1917.TX.E27.14.TX11 alu satin
- 1917.TX.E27.23.TX23 dark bronze
- 1917.TX.E27.29.TX2 black - gold in

built-up



1918.B2.E27/.. - OLIVIA MINI

~230V IP20 0,7 m 0,5650 1 m 05.20.02 CE



pendant with swivel and built-up base - rod can be shortened  
 Pendelleuchte mit Kugelgelenk und Aufbaurosette - kürzbare Stange

**Lamp type**  
 1x TC-SEI E27 max. 11W A - B 230V

**Dimensions**  
 Ø100 - Bar 700  
 Ø54xH60

**Materials**  
 aluminium 14 | 1M | 2M  
 brass 13 | 23

Ref	
1918.B2.E27.1M	white tex
1918.B2.E27.2M	black tex
1918.B2.E27.13	bronze
1918.B2.E27.14	alu satin
1918.B2.E27.23	dark bronze

built-up

1918.B2.ES50/.. - OLIVIA MINI

~230V IP20 0,7 m 0,2750 1 m 05.20.02 CE



pendant with swivel and built-up base - rod can be shortened  
 Pendelleuchte mit Kugelgelenk und Aufbaurosette - kürzbare Stange

**Lamp type**  
 1x QPAR 51 GU10 max. 20W A - E 230V

**Dimensions**  
 Ø100 - Bar 700  
 Ø54xH60

**Materials**  
 aluminium 14 | 1M | 2M  
 brass 13 | 23

Ref	
1918.B2.ES50.1M	white tex
1918.B2.ES50.2M	black tex
1918.B2.ES50.13	bronze
1918.B2.ES50.14	alu satin
1918.B2.ES50.23	dark bronze

built-up

1918.B3.E27/.. - OLIVIA MINI - B3

~230V IP20 0,8 m 0,3000 1 m 05.20.02 CE



pendant with swivel - rod can be shortened  
 Pendelleuchte mit Kugelgelenk - kürzbare Stange

**Lamp type**  
 1x TC-SEI E27 max. 11W A - B 230V

**Dimensions**  
 Ø100 - Bar 800

**Materials**  
 aluminium 14 | 1M | 29 | 2M  
 brass 13 | 23

Ref	
1918.B3.E27.1M	white tex
1918.B3.E27.2M	black tex
1918.B3.E27.13	bronze
1918.B3.E27.14	alu satin
1918.B3.E27.23	dark bronze
1918.B3.E27.29	black - gold in

built-up  
 without base  
 ohne Basis

1918.B3.ES50/.. - OLIVIA MINI - B3

~230V IP20 0,8 m 0,5300 1 m 05.20.02 CE



pendant with swivel - rod can be shortened  
 Pendelleuchte mit Kugelgelenk - kürzbare Stange

**Lamp type**  
 1x QPAR 51 GU10 max. 20W A - E 230V

**Dimensions**  
 Ø100 - Bar 800

**Materials**  
 aluminium 14 | 1M | 29 | 2M  
 brass 13 | 23

Ref	
1918.B3.ES50.1M	white tex
1918.B3.ES50.2M	black tex
1918.B3.ES50.13	bronze
1918.B3.ES50.14	alu satin
1918.B3.ES50.23	dark bronze
1918.B3.ES50.29	black - gold in

built-up  
 without base  
 ohne Basis

1919.E27/.. - OLIVIA MINI

~230V IP20 0,8 m 5,6600 1 m 05.20.02 CE



pendant with swivel - rod can be shortened  
 Pendelleuchte mit Kugelgelenk - kürzbare Stange

Lamp type

3x TC-SEI E27 max. 11W A - B 230V

Dimensions

L900xB110xH760 - Bar 800

L430xB60xH30

Materials

aluminium 14 | 1M | 2M  
 brass 13 | 23

Ref

1919.E27.1M white tex  
 1919.E27.2M black tex  
 1919.E27.13 bronze  
 1919.E27.14 alu satin  
 1919.E27.23 dark bronze

built-up

1919.ES50/.. - OLIVIA MINI

~230V IP20 0,8 m 6,5200 1 m 05.20.02 CE



pendant with swivel - rod can be shortened  
 Pendelleuchte mit Kugelgelenk - kürzbare Stange

Lamp type

3x QPAR 51 GU10 max. 20W A+ - E 230V

Dimensions

L900xB110xH760 - Bar 800

L430xB60xH30

Materials

aluminium 14 | 1M | 2M  
 brass 13 | 23

Ref

1919.ES50.1M white tex  
 1919.ES50.2M black tex  
 1919.ES50.13 bronze  
 1919.ES50.14 alu satin  
 1919.ES50.23 dark bronze

built-up



1806/.. - OLIVIA PENDEL E27 - TX

~230V IP20 1,5 m 0,6000 1 m 05.20.02 CE



built-up

pendant - with 1,5m textile cable and strain relief on lampholder's side  
 Pendelleuchte - mit 1,5m Textilkabel und Zugentlastung an Fassung

<b>Lamptype</b>	1x A60 E27 max. 28W <span style="color: green;">A</span> - <span style="color: red;">E</span>	230V
<b>Dimensions</b>	Ø162xH140 - Cable 1500	
<b>Materials</b>	aluminium 14   1M   29   2M   47	
	brass 13   23	
	red copper 28   52	

<b>Ref</b>	1806.1M.TX1	white tex
	1806.2M.TX1	black tex
	1806.13.TX8	bronze
	1806.14.TX11	alu satin
	1806.23.TX23	dark bronze
	1806.28.TX2	rosé
	1806.29.TX2	black - gold in
	1806.47.TX2	black - white in
	1806.52.TX2	black out - RC in

1807.B2.E27/.. - OLIVIA PENDEL E27

~230V IP20 0,7 m 1,3500 1 m 05.20.02 CE



built-up  
 other lengths available on request  
 andere Längen auf Anfrage

pendant with swivel and built-up base - rod can be shortened  
 Pendelleuchte mit Kugelgelenk und Aufbaurosette - kürzbare Stange

<b>Lamptype</b>	1x A60 E27 max. 28W <span style="color: green;">A</span> - <span style="color: red;">E</span>	230V
<b>Dimensions</b>	Ø162xH140 - Bar 700 Ø54xH60	
<b>Materials</b>	aluminium 14   1M   29   2M	
	brass 13   23	

<b>Ref</b>	1807.B2.E27.1M	white tex
	1807.B2.E27.2M	black tex
	1807.B2.E27.13	bronze
	1807.B2.E27.14	alu satin
	1807.B2.E27.23	dark bronze
	1807.B2.E27.29	black - gold in

1807.B3.E27/.. - OLIVIA PENDEL E27 - B3

~230V IP20 0,8 m 0,5400 1 m 05.20.02 CE



built-up  
 without base  
 ohne Basis

pendant with swivel - rod can be shortened  
 Pendelleuchte mit Kugelgelenk - kürzbare Stange

<b>Lamptype</b>	1x A60 E27 max. 28W <span style="color: green;">A</span> - <span style="color: red;">E</span>	230V
<b>Dimensions</b>	Ø162xH140 - Bar 800	
<b>Materials</b>	aluminium 14   1M   2M	
	brass 13   23	
	red copper 52	

<b>Ref</b>	1807.B3.E27.1M	white tex
	1807.B3.E27.2M	black tex
	1807.B3.E27.13	bronze
	1807.B3.E27.14	alu satin
	1807.B3.E27.23	dark bronze
	1807.B3.E27.52	black out - RC in





1817.B1/.. - OLIVIA PENDEL B1

~230V     IP20    0,7 m  1,5600  1 m  05.20.50 





pendant with swivel and built-up base - rod can be shortened  
- with transformer - with LED driver  
Pendelleuchte mit Kugelgelenk und Aufbaurosette - kürzbare  
Stange - mit Trafo - mit Driver LED

Lamp type

 1x QR-LP111 G53 max. 50W  12V  
 1x powered 350mA max. 1W  350mA

Dimensions

 Ø162xH140 - Bar 700  
 Ø90xH85

Ref

1817.B1.1M	B   CW   WW
1817.B1.2M.B	B   CW   WW
1817.B1.11M.B	B   CW   WW
1817.B1.13	B   CW   WW
1817.B1.14.B	B   CW   WW
1817.B1.23.B	B   CW   WW
1817.B1.11M.14.B	B   CW   WW
1817.B1.2M.7	B   CW   WW

built-up

1817.B3/.. - OLIVIA PENDEL B3 - B3

~12V/=350mA    IP20    0,8 m  1,3250  1 m  05.20.50 



pendant with swivel - rod can be shortened - without  
transformer - without LED driver  
Pendelleuchte mit Kugelgelenk - kürzbare Stange - ohne  
Trafo - ohne Driver LED

Lamp type

 1x QR-LP111 G53 max. 50W  12V  
 1x powered 350mA max. 1W  350mA

Dimensions

 Ø162xH140 - Bar 800



Ref

1817.B3.1M	B   CW   WW
1817.B3.2M.B	B   CW   WW
1817.B3.11M.B	B   CW   WW
1817.B3.13	B   CW   WW
1817.B3.14.B	B   CW   WW
1817.B3.23.B	B   CW   WW



built-up  
without base  
ohne Rosette



1818.B2/.. - OLIVIA PENDEL ES111

~230V  IP20    0,7 m  1,1850  0,5 m  05.20.02 





pendant with swivel and built-up base - rod can be shortened  
Pendelleuchte mit Kugelgelenk und Aufbaurosette - kürzbare  
Stange

Lamp type

 1x QPAR111 GU10 max. 75W  230V

Dimensions

 Ø162xH140 - Bar 700  
 Ø54xH60

Materials

aluminium 14 | 1M | 2M | 11M

Ref

1818.B2.1M.1M	white tex
1818.B2.2M.2M	black tex
1818.B2.11M.11M	grey tex
1818.B2.14.14	alu satin

built-up



1805.E27.3/.. - OLIVIA - B3

~230V   IP20     1 m  05.20.50  CE



pendant with swivel - rod can be shortened - with 3x Olivia on base Juba - with LED driver  
 Pendelleuchte mit Kugelgelenk - kürzbare Stange - mit 3x Olivia auf Basis Juba - mit Driver LED

Lamp type

 3x QR-LP111 G53 max. 50W  12V  
 1x powered 350mA max. 1W  350mA

Dimensions

 L900xB162xH980 - Bar 800  
 Base - L900xB50xH40  
 Cone - Ø162xH140

Materials

aluminium 14 | 1M | 2M  
 brass 7 | 16

Ref

1805.E27.3.1M	white tex
1805.E27.3.2M	black tex
1805.E27.3.7	chrome
1805.E27.3.14	alu satin
1805.E27.3.16	satin gold
1805.E27.3.216	black - gold

built-up

1805.3/.. - OLIVIA - B3

~230V   IP20     1 m  05.20.50  CE



pendant with swivel - rod can be shortened - with 3x Olivia on base Juba - with LED driver  
 Pendelleuchte mit Kugelgelenk - kürzbare Stange - mit 3x Olivia auf Basis Juba - mit Driver LED

Lamp type

 3x A60 E27 max. 28W  230V

Dimensions

 L900xB162xH980 - Bar 800  
 Base - L900xB50xH40  
 Cone - Ø162xH140

Ref

1805.3.1M.B	B   NW
1805.3.2M.B	B   NW
1805.3.7.B	B   NW
1805.3.14.B	B   NW

built-up

1856.E27.3/.. - OLIVIA - B3

~230V   IP20     1 m  05.20.50  CE



pendant with swivel - rod can be shortened - with 3x Olivia on base Rondobox - with LED driver  
 Pendelleuchte mit Kugelgelenk - kürzbare Stange - mit 3x Olivia auf Basis Rondobox - mit Driver LED

Lamp type

 3x A60 E27 max. 28W  230V

Dimensions

 Ø162xH140 - Bar 800

Materials

aluminium 14 | 1M | 2M

Ref

1856.E27.3.1M	white tex
1856.E27.3.2M	black tex
1856.E27.3.14	alu satin
1856.E27.3.216	black - gold

built-up





1856.3/.. - OLIVIA - B3

~230V   IP20     1 m  05.20.50  CE



pendant with swivel - rod can be shortened - with 3x Olivia on base Rondobox - with LED driver  
 Pendelleuchte mit Kugelgelenk - kürzbare Stange - mit 3x Olivia auf Basis Rondobox - mit Driver LED

Lamp type

 3x QR-LP111 G53 max. 50W  12V  
 1x powered 350mA max. 1W  350mA

Dimensions

 Ø350xH968 - Bar 800  
 Base - Ø350xH28  
 Cone - Ø162xH140

Ref

1856.3.1M.B	B   NW
1856.3.2M.B	B   NW
1856.3.14.B	B   NW

built-up

# INDOOR | Ceiling UP | Pendants | ZUMBA - TWIPE

chrome or other colours on request  
 Chrom oder andere Farben auf Anfrage

## 1930.TX/.. - ZUMBA

~230V IP20 1,5 m 0,5 m 05.20.02 CE



pendant - with 1,5m textile cable and strain relief on lampholder's side  
 Pendelleuchte - mit 1,5m Textilkabel und Zugentlastung an Fassung

**Lamp type**  
 1x A60 E27 max. 42W A E 230V

**Dimensions**  
 Ø140xH150 - Cable 1500

**Materials**  
 aluminium 1M | 29 | 2M | 49

Ref	
1930.TX.1M.TX1	white tex
1930.TX.2M.TX2	black tex
1930.TX.29.TX2	black - gold in
1930.TX.49.TX1	white - gold in

built-up

## 1930.B3/.. - ZUMBA

~230V IP20 0,8 m 0,5 m 05.20.02 CE



pendant with swivel - rod can be shortened  
 Pendelleuchte mit Kugelgelenk - kürzbare Stange

**Lamp type**  
 1x A60 E27 max. 42W A E 230V

**Dimensions**  
 Ø140xH150 - Bar 800

**Materials**  
 aluminium 1M | 29 | 2M | 49

Ref	
1930.B3.2M	black tex
1930.B3.1M.TX1	white tex
1930.B3.29.TX2	black - gold in
1930.B3.49	white - gold in

built-up

## 1804.B3/.. - TWIPE - B3

~230V IP20 0,8 m 0,6400 0,5 m 05.20.02 CE



pendant with swivel - rod can be shortened  
 Pendelleuchte mit Kugelgelenk - kürzbare Stange

**Lamp type**  
 1x A60 E27 max. 42W A E 230V

**Dimensions**  
 Ø200xH400 - Bar 800

**Materials**  
 aluminium 1M | 29 | 2M | 49

Ref	
1804.B3.1M	white tex
1804.B3.2M	black tex
1804.B3.29	black - gold in
1804.B3.49	white - gold in

built-up  
 other °angle reflector on demand  
 andere °Winkel Reflektor auf Anfrage

## 1804.TX/.. - TWIPE - B3

~230V IP20 1,5 m 0,5 m 05.20.02 CE



pendant - with 1,5m textile cable and strain relief on lampholder's side  
 Pendelleuchte - mit 1,5m Textilkabel und Zugentlastung an Fassung

**Lamp type**  
 1x A60 E27 max. 42W A E 230V

**Dimensions**  
 Ø200xH400 - Cable 1500

**Materials**  
 aluminium 1M | 29 | 2M | 49

Ref	
1804.TX.1M	white tex
1804.TX.2M	black tex
1804.TX.29	black - gold in
1804.TX.49	white - gold in



built-up  
 other °angle reflector on demand  
 andere °Winkel Reflektor auf Anfrage

1178/.. - SPACE

~230V  IP20    1,5 m  0,5 m  



pendant - with 1,5m textile cable and strain relief on lampholder's side  
 Pendelleuchte - mit 1,5m Textilkabel und Zugentlastung an Fassung

**Lamp type**  
 1x LED 1300lm CRI80 max. 12W  230V

**Dimensions**  
 Ø400xH150 - Cable 1500

**Materials**  
 aluminium 1M | 29 | 2M | 47

Ref	
1178.1M.WW	white tex
1178.2M.WW	black tex
1178.29.WW	black - gold in
1178.47.WW	black - white in



built-up

4003.B3/.. - TUBA - B3

~12V   IP20    0,8 m  0,2360 0,5 m  



pendant with swivel - rod can be shortened - without transformer  
 Pendelleuchte mit Kugelgelenk - kürzbare Stange - ohne Trafo

**Lamp type**  
 1x QR-CB 51 GU5,3/GX5,3 max. 35W  -  12V

**Dimensions**  
 Ø60xH121 - Bar 800

**Materials**  
 aluminium 1 | 2 | 11 | 14  
 brass 4 | 13 | 16

Ref	
4003.B3.1	white
4003.B3.2	black
4003.B3.4	shiny gold
4003.B3.11	alu grey
4003.B3.13	bronze
4003.B3.14	alu satin
4003.B3.16	satin gold

built-up  
 use coolfit lamp  
 Coolfit-Lampe verwenden





1824/.. - NAOMI XICATO - B3

=500mA IP20 0,8 m



pendant with swivel - rod can be shortened - without LED driver  
 Pendelleuchte mit Kugelgelenk - kürzbare Stange - ohne Driver LED

Ref  
 1824.14 NW | WW

Lamp type

1x Led 965lm CRI80 max. 6,6W - 500mA

Dimensions

Ø110xH33 - Bar 800

built-up

1824X3/.. - NAOMI SET 3 XICATO - B3

~230V IP20 0,8 m



pendant with swivel - rod can be shortened - with LED driver  
 Pendelleuchte mit Kugelgelenk - kürzbare Stange - mit Driver LED

Ref  
 1824X3.14 NW | WW

Lamp type

3x Led 965lm CRI80 max. 6,6W - 500mA

Dimensions

Ø110xH33 - Bar 800

Base - L1200xB50xH40

Rod - L800

built-up

1826/.. - NAOMI XICATO - B3

=500mA IP20 0,8 m



pendant with swivel - rod can be shortened - without LED driver  
 Pendelleuchte mit Kugelgelenk - kürzbare Stange - ohne Driver LED

Ref  
 1826.1M NW | WW  
 1826.2M NW | WW  
 1826.4 NW | WW  
 1826.13 NW | WW  
 1826.14 NW | WW  
 1826.23 NW | WW

Lamp type

1x Led 965lm CRI80 max. 6,6W - 500mA

Dimensions

Ø120xH33 - Bar 800

built-up

1826X3/.. - NAOMI SET 3 XICATO - B3

~230V IP20 0,8 m



pendant with swivel - rod can be shortened - with LED driver  
 Pendelleuchte mit Kugelgelenk - kürzbare Stange - mit Driver LED

Ref  
 1826X3.1M NW | WW  
 1826X3.2M NW | WW  
 1826X3.4 NW | WW  
 1826X3.13 NW | WW  
 1826X3.14 NW | WW  
 1826X3.23 NW | WW

Lamp type

3x Led 965lm CRI80 max. 6,6W - 500mA

Dimensions

Ø120xH33 - Bar 800

Base - L1200xB40xH50

Rod - L800

built-up

1827.IP20/.. - NAOMI XICATO - B3

=350mA IP20 0,8 m



pendant with swivel - down - rod can be shortened - without LED driver  
 Pendelleuchte mit Kugelgelenk - down - kürzbare Stange - ohne Driver LED

Ref	
1827.IP20.1M	NW   WW
1827.IP20.2M	NW   WW
1827.IP20.14	NW   WW

**Lamp type**  
 1x Led 720lm CRI80 max. 4,5W - 350mA

**Dimensions**  
 Ø55xH110 40° reflector - Bar 800  
 Reflector - Ø50

built-up

1827X3.IP20/.. - NAOMI SET 3 XICATO - B3

~230V IP20 0,8 m



pendant with swivel - down - rod can be shortened - with LED driver  
 Pendelleuchte mit Kugelgelenk - down - kürzbare Stange - mit Driver LED

Ref	
1827X3.IP20.1M	NW   WW
1827X3.IP20.2M	NW   WW
1827X3.IP20.14	NW   WW

**Lamp type**  
 3x Led 720lm CRI80 max. 4,5W - 350mA

**Dimensions**  
 Ø55xH110 40° reflector - Bar 800  
 Reflector - Ø50  
 Base - L1200xB40xH50  
 Rod - L800

built-up

1828.IP20/.. - NAOMI XICATO - B3

=500mA IP20 0,8 m



pendant with swivel - down - rod can be shortened - without LED driver  
 Pendelleuchte mit Kugelgelenk - down - kürzbare Stange - ohne Driver LED

Ref	
1828.IP20.1M	NW   WW
1828.IP20.2M	NW   WW
1828.IP20.14	NW   WW

**Lamp type**  
 1x Led 965lm CRI80 max. 6,6W - 500mA

**Dimensions**  
 Ø75xH107 40° reflector - Bar 800  
 Reflector - Ø70

built-up

1828X3.IP20/.. - NAOMI SET 3 XICATO - B3

~230V IP20 0,8 m



pendant with swivel - down - rod can be shortened - with LED driver  
 Pendelleuchte mit Kugelgelenk - down - kürzbare Stange - mit Driver LED

Ref	
1828X3.IP20.1M	NW   WW
1828X3.IP20.2M	NW   WW
1828X3.IP20.14	NW   WW

**Lamp type**  
 3x Led 965lm CRI80 max. 6,6W - 500mA

**Dimensions**  
 Ø75xH107 40° reflector  
 Reflector - Ø70  
 Base - L1200xB40xH50  
 Rod - L800

built-up

1829.IP20/.. - NAOMI XICATO - B3



=500mA   IP20   0,8 m   



pendant with swivel - down - rod can be shortened - without LED driver  
 Pendelleuchte mit Kugelgelenk - down - kürzbare Stange - ohne Driver LED

Ref	
1829.IP20.1M	NW   WW
1829.IP20.2M	NW   WW
1829.IP20.14	NW   WW

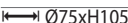
**Lamp type**  
 1x Led 965lm CRI80 max. 6,6W  500mA

**Dimensions**  
 Ø75xH105  40° reflector - Bar 800  
 Reflector - Ø70

built-up

1829X3.IP20/.. - NAOMI SET 3 XICATO - B3



~230V   IP20   0,8 m   



pendant with swivel - down - rod can be shortened - with LED driver  
 Pendelleuchte mit Kugelgelenk - down - kürzbare Stange - mit Driver LED

Ref	
1829X3.IP20.1M	NW   WW
1829X3.IP20.2M	NW   WW
1829X3.IP20.14	NW   WW

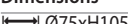
**Lamp type**  
 3x Led 965lm CRI80 max. 6,6W  500mA

**Dimensions**  
 Ø75xH105  40° reflector - Bar 800  
 Reflector - Ø70  
 Base - L1200xB40xH50  
 Rod - L800

built-up

PENDANTS

4025.B3/.. - MAX - B3

~12V IP20 0,8 m



pendant with swivel - rod can be shortened - without transformer  
 Pendelleuchte mit Kugelgelenk - kürzbare Stange - ohne Trafo

Ref	
4025.B3.2M	black tex
4025.B3.14	alu satin
4025.B3.16	satin gold

**Lamp type**  
 1x QT12 GY6,35 max. 35W - 12V

**Dimensions**  
 L60xB60xH150 - Bar 800

**Materials**  
 aluminium 14 | 2M  
 brass 16

built-up

4025.G9.B3/.. - MAX G9 - M10

~230V IP20 0,8 m



pendant with swivel - rod can be shortened  
 Pendelleuchte mit Kugelgelenk - kürzbare Stange

Ref	
4025.G9.B3.1M	white tex
4025.G9.B3.2M	black tex
4025.G9.B3.14	alu satin
4025.G9.B3.16	satin gold
4025.G9.B3.23	dark bronze

**Lamp type**  
 1x QT14 G9 max. 25W - 230V

**Dimensions**  
 L60xB60xH150 - Bar 800

**Materials**  
 aluminium 14 | 1M | 2M  
 brass 16 | 23

built-up

461507/.. - MAX spare glass

IP20



spare glass - opal white  
 Ersatzglas - Opalweiß

Ref	
461507	

**Dimensions**  
 L60xB60xH150

rod not included  
 Stange nicht einbegriffen

4024.G9.B3/.. - MAXI - B3

~230V IP20 0,8 m



pendant with swivel - rod can be shortened  
 Pendelleuchte mit Kugelgelenk - kürzbare Stange

Ref	
4024.G9.B3.1M	white tex
4024.G9.B3.2M	black tex
4024.G9.B3.14	alu satin
4024.G9.B3.16	satin gold
4024.G9.B3.23	dark bronze

**Lamp type**  
 1x QT14 G9 max. 20W - 230V

**Dimensions**  
 L90xB90xH150 - Bar 800

**Materials**  
 aluminium 14 | 1M | 2M  
 brass 16 | 23

built-up



1472.1/.. - FLEX

~230V IP20 0 m 0,5 m 05.20.02 CE



pendant - directional - with flexible arm  
 Pendelleuchte - schwenkbar - mit Flexibele Tube

Ref  
 1472.1.2M black tex

**Lamp type**  
 1x A60 E27 max. 10,5W **A** - **E** 230V

**Dimensions**  
 Ø800xH750 - 500

Base -

**Materials**  
 aluminium 2M

built-up

1472.2/.. - FLEX

~230V IP20 0 m 0,5 m 05.20.02 CE



pendant - directional - with flexible arm  
 Pendelleuchte - schwenkbar - mit Flexibele Tube

Ref  
 1472.2.2M black tex

**Lamp type**  
 2x A60 E27 max. 10,5W **A** - **E** 230V

**Dimensions**  
 Ø800xH750 - 500

Base -

**Materials**  
 aluminium 2M

built-up

1472.3/.. - FLEX

~230V IP20 0 m 0,5 m 05.20.02 CE



pendant - directional - with flexible arm  
 Pendelleuchte - schwenkbar - mit Flexibele Tube

Ref  
 1472.3.1M white tex  
 1472.3.2M black tex

**Lamp type**  
 3x A60 E27 max. 10,5W **A** - **E** 230V

**Dimensions**  
 Ø800xH750 - 500

Base -

**Materials**  
 aluminium 1M | 2M

built-up

1472.5/.. - FLEX

~230V IP20 0,5 m 0,5 m 05.20.02 CE



pendant - directional - with flexible arm  
 Pendelleuchte - schwenkbar - mit Flexibele Tube

Ref  
 1472.5.2M black tex

**Lamp type**  
 5x A60 E27 max. 10,5W **A** - **E** 230V

**Dimensions**  
 Ø800xH750 - Flex 500

Base -

**Materials**  
 aluminium 2M

built-up



# INDOOR | Ceiling UP | Pendants | ORKA

LED colours: cold white (CW) or warm white (WW) - other LED colours on request

LED Farben: kalt Weiß (CW) oder warm Weiß (WW) - andere LED Farben auf Anfrage



## 3087.B1/.. - ORKA PENDEL B1



~230V   IP20  0,8 m   



pendant with swivel and built-up base - down - rod can be shortened - with LED driver  
 Pendelleuchte mit Kugelgelenk und Aufbaurosette - down - kürzbare Stange - mit Driver LED

**Ref**  
 3087.B1.14.CW alu satin  
 3087.B1.14.WW alu satin

**Lamp type**  
 1x powered 700mA max. 3W  -  700mA

**Dimensions**  
 Ø50  40° reflector - Bar 800  
 Ø60xH90

**Materials**  
 aluminium 14

*built-up*  
 other °angle reflector on demand  
 andere °Winkel Reflektor auf Anfrage



## 3087.B3/.. - ORKA PENDEL B3



=700mA   IP20  0,8 m    



pendant with swivel - rod can be shortened - down - without LED driver  
 Pendelleuchte mit Kugelgelenk - kürzbare Stange - down - ohne Driver LED

**Ref**  
 3087.B3.14.CW alu satin  
 3087.B3.14.WW alu satin

**Lamp type**  
 1x powered 700mA max. 3W  -  700mA

**Dimensions**  
 Ø50  40° reflector - Bar 800

**Materials**  
 aluminium 14

*built-up*  
 other °angle reflector on demand  
 andere °Winkel Reflektor auf Anfrage



## 3089/.. - ORKA 9



~230V   IP20  0,5 m    



ceiling light - down - rods 4x30cm - 4x40cm - 1x50cm - with LED driver  
 Deckenleuchte - down - Stangen 4x30cm - 4x40cm - 1x50cm - mit Driver LED

**Ref**  
 3089.14.CW alu satin  
 3089.14.WW alu satin

**Lamp type**  
 9x powered 700mA max. 3W  -  700mA

**Dimensions**  
 Ø350xH530  40° reflector - Bar 500  
 Ø320xH25

**Materials**  
 aluminium 14

*built-up*  
 other °angle reflector on demand  
 andere °Winkel Reflektor auf Anfrage

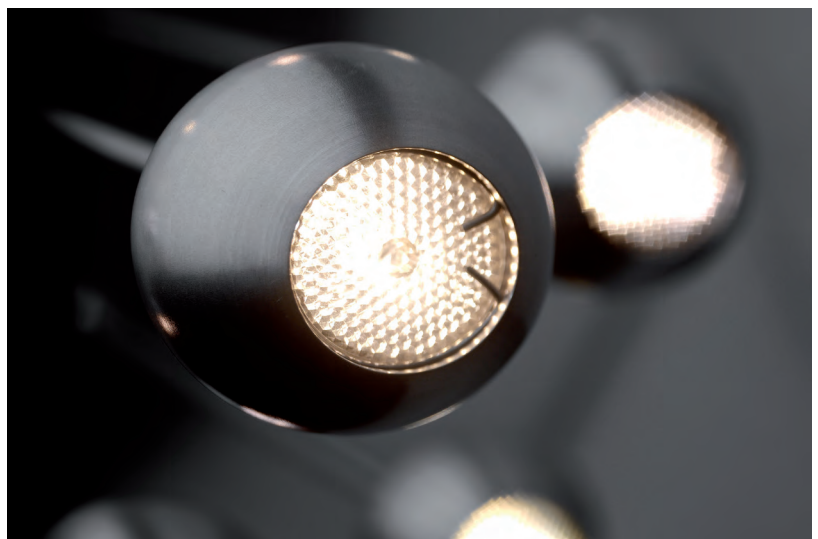

3999.G9.B3/.. - PIVA - B3

~230V IP20 0,8 m 0,1400 1 m 05.20.02 CE



pendant with swivel - rod can be shortened  
Pendelleuchte mit Kugelgelenk - kürzbare Stange

**Lamp type**  
1x QT14 G9 max. 25W **A** - **E** 230V

**Dimensions**  
Ø30 - Bar 800

**Options**  
GL5796B - GLASS  
GL5796O - GLASS  
GL5796S - GLASS

**Materials**  
aluminium 1 | 2 | 11 | 14  
brass 4 | 13 | 16

Ref	
3999.G9.B3.1	white
3999.G9.B3.2	black
3999.G9.B3.4	shiny gold
3999.G9.B3.11	alu grey
3999.G9.B3.13	bronze
3999.G9.B3.14	alu satin
3999.G9.B3.16	satin gold

built-up  
glass to be ordered separately  
Glas separat bestellen

4001.G9.B3/.. - PIVA - B3

~230V IP20 0,8 m 0,3100 0,5 m 05.20.02 CE



pendant with swivel - rod can be shortened  
Pendelleuchte mit Kugelgelenk - kürzbare Stange

**Lamp type**  
1x QT14 G9 max. 25W **A** - **E** 230V

**Dimensions**  
Ø30 - Bar 800

**Materials**  
aluminium 1 | 2 | 11 | 14 | 2M  
brass 4 | 13 | 16 | 23

Ref	
4001.G9.B3.1	white
4001.G9.B3.2	black
4001.G9.B3.2M	black tex
4001.G9.B3.4	shiny gold
4001.G9.B3.11	alu grey
4001.G9.B3.13	bronze
4001.G9.B3.14	alu satin
4001.G9.B3.16	satin gold
4001.G9.B3.23	dark bronze

built-up  
glass to order separately  
Glas separat bestellen

4001.G4.B3/.. - PIVA - B3

~12V III IP20 0,8 m 0,3060 0,5 m 05.20.02 CE



pendant with swivel - rod can be shortened - without transformer  
Pendelleuchte mit Kugelgelenk - kürzbare Stange - ohne Trafo

**Lamp type**  
1x QT9-ax G4 max. 20W **A** - **E** 12V

**Dimensions**  
Ø30 - Bar 800

**Materials**  
aluminium 1 | 2 | 11 | 14 | 2M  
brass 4 | 13 | 16

Ref	
4001.G4.B3.1	white
4001.G4.B3.2	black
4001.G4.B3.2M	black tex
4001.G4.B3.4	shiny gold
4001.G4.B3.11	alu grey
4001.G4.B3.13	bronze
4001.G4.B3.14	alu satin
4001.G4.B3.16	satin gold

built-up  
glass to order separately  
Glas separat bestellen

GL5994CA/.. - GLASS G4-G9

IP20 0,5300 CE



Glass - Ceramico Ambra  
Glas - Amber Keramik

**Dimensions**  
Ø140xH95

**Options**  
4001.G4.B3 - PIVA  
4001.G9.B3 - PIVA

Ref	
GL5994CA	

rod not included  
Stange nicht einbegriffen



GL1135S/.. - GLASS G4-G9

IP20   



Glass - silk satin  
Glas - silk Satin

**Dimensions**

↔ Ø175xH135

**Options**

4001.G4.B3 - PIVA  
4001.G9.B3 - PIVA

Ref

GL1135S

rod not included  
Stange nicht einbegriffen

GL423S/.. - GLASS G4-G9

IP20    0,7920 



Glass - silk satin  
Glas - silk Satin

**Dimensions**

↔ Ø125-24xH165

**Options**

4001.G4.B3 - PIVA  
4001.G9.B3 - PIVA

Ref

GL423S

rod not included  
Stange nicht einbegriffen

GL8285S/.. - GLASS G4-G9

IP20    0,4654 



Glass - silk satin  
Glas - silk Satin

**Dimensions**

↔ Ø95xH100

**Options**

4001.G4.B3 - PIVA  
4001.G9.B3 - PIVA

Ref

GL8285S

rod not included  
Stange nicht einbegriffen

GL5434WN/.. - GLASS G4-G9

IP20    0,3918 



Glass - wenge incrociato nero  
Glas - Schliff Wenge Schwarz

**Dimensions**

↔ Ø140xH100

**Options**

4001.G4.B3 - PIVA  
4001.G9.B3 - PIVA

Ref

GL5434WN

rod not included  
Stange nicht einbegriffen

**GL413G/.. - GLASS G4-G9**

IP20    0,3320 



Glass - Robellat Oro  
 Glas - Robellat Oro

Ref  
 GL413G

**Dimensions**  
 Ø95xH110

**Options**  
 4001.G4.B3 - PIVA  
 4001.G9.B3 - PIVA

rod not included  
 Stange nicht einbegriffen

**GL8285BC/.. - GLASS G4-G9**

IP20    0,4928 



Glass - Bean Coffee  
 Glas - Bean Coffee

Ref  
 GL8285BC

**Dimensions**  
 Ø95xH100

**Options**  
 4001.G4.B3 - PIVA  
 4001.G9.B3 - PIVA

rod not included  
 Stange nicht einbegriffen

**GL8285W/.. - GLASS G4-G9**

IP20    0,4482 



Glass - wenge  
 Glas - Wenge

Ref  
 GL8285W

**Dimensions**  
 Ø95xH100

**Options**  
 4001.G4.B3 - PIVA  
 4001.G9.B3 - PIVA

rod not included  
 Stange nicht einbegriffen

**2338074/.. - PIVA**

IP20   



Glass - glass black/gold included  
 Glas - Glass Schwarz/Gold einbegriffen

Ref  
 2338074

**Dimensions**  
 Ø140xH95

**Options**  
 4001.G4.B3 - PIVA  
 4001.G9.B3 - PIVA

rod not included  
 Stange nicht einbegriffen

5031/.. - PIVA PENDANT

~230V



IP20



0,8 m



0,5 m



pendant with swivel and built-up base  
 Pendelleuchte mit Kugelgelenk und Aufbaurosette

**Lamp type**

5x QT14 G9 max. 25W A - E 230V

**Dimensions**

L1000xB25xH130 - Bar 800

L560xB60

Base - L600xB100xH35

**Materials**

aluminium 14 | 1M | 2M | 46

**Ref**

5031.1M	white tex
5031.2M	black tex
5031.14	alu satin
5031.46	grey-brown

built-up

PENDANTS



4040/.. - OPERA HORIZ.

~230V   IP20     1,5 m  2,0650  1 m  05.20.02 



pendant - directional - with transformer  
Pendelleuchte - schwenkbar - mit Trafo

Lamp type

1x QR-LP111 G53 max. 12W  12V  
or 1x PAR 36 screw max. 50W  12V

Dimensions

L192xB185xH87  
L110xB80xH35

Materials

aluminium 14 | 1M | 2M

Ref

4040.1M white tex  
4040.2M black tex  
4040.14 alu satin

built-up  
standard with mounting plate  
standard mit Deckenplatte

4041/.. - OPERA VERT.

~230V   IP20     1,5 m  1,7800  1 m  05.20.02 



pendant - directional - with transformer  
Pendelleuchte - schwenkbar - mit Trafo

Lamp type

1x QR-LP111 G53 max. 12W  12V  
or 1x PAR 36 screw max. 50W  12V

Dimensions

L192xB87xH185  
L110xB80xH35

Materials

aluminium 14 | 1M | 2M

Ref

4041.1M white tex  
4041.2M black tex  
4041.14 alu satin

built-up  
standard with mounting plate  
standard mit Deckenplatte

4006/.. - OPERA

~230V   IP20     1,5 m  2,4000  1 m  05.20.02 



pendant - directional - with transformer  
Pendelleuchte - schwenkbar - mit Trafo

Lamp type

2x QR-LP111 G53 max. 12W  12V

Dimensions

L410xB193xH1500  
L105xB65

Materials

aluminium 14 | 1M | 2M

Ref

4006.1M white tex  
4006.2M black tex  
4006.14 alu satin

built-up  
standard with mounting plate  
standard mit Deckenplatte

4007/.. - OPERA

~230V   IP20     1,5 m  3,5350  1 m  05.20.02 



pendant - directional - with transformer  
Pendelleuchte - schwenkbar - mit Trafo

Lamp type

4x QR-LP111 G53 max. 12W  12V

Dimensions

L410xB304xH1500 - Cable 1500  
L105xB65

Materials

aluminium 14 | 1M | 2M

Ref

4007.1M white tex  
4007.2M black tex  
4007.14 alu satin

built-up  
standard with mounting plate  
standard mit Deckenplatte



INDOOR | Ceiling UP | Pendants | OPERA PENDANT

4008/.. - OPERA

~230V

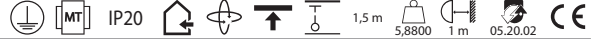

pendant - directional - with transformer  
Pendelleuchte - schwenkbar - mit Trafo

Lamp type

6x QR-LP111 G53 max. 12W A - C 12V  
or 6x PAR 36 screw max. 50W E 12V

Dimensions

L410xB536xH1500  
L105xB65

Materials

aluminium 14 | 1M | 2M

Ref

4008.1M white tex  
4008.2M black tex  
4008.14 alu satin

built-up  
standard with mounting plate  
standard mit Deckenplatte

4009/.. - OPERA

~230V



ceiling light - directional - on rod - with transformer  
Deckenleuchte - schwenkbar - auf Stange - mit Trafo

Lamp type

4x QR-LP111 G53 max. 12W A - C 12V  
or 4x PAR 36 screw max. 50W E 12V

Dimensions

L410xB364xH545  
Ø100

Materials

aluminium 14 | 1M | 2M

Ref

4009.1M white tex  
4009.2M black tex  
4009.14 alu satin

built-up  
standard with mounting plate  
standard mit Deckenplatte

1435/.. - OPERA 4 IN LINE

~230V



pendant - directional - with transformer  
Pendelleuchte - schwenkbar - mit Trafo

Lamp type

4x QR-LP111 G53 max. 12W A - C 12V  
or 4x PAR 36 screw max. 50W E 12V

Dimensions

L810xB192xH90  
L385xB105xH20

Materials

aluminium 14 | 1M | 2M

Ref

1435.1M white tex  
1435.2M black tex  
1435.14 alu satin

built-up  
standard with mounting plate  
standard mit Deckenplatte

1438/.. - OPERA 6 IN LINE

~230V



pendant - directional - with transformer  
Pendelleuchte - schwenkbar - mit Trafo

Lamp type

6x QR-LP111 G53 max. 12W A - C 12V  
or 6x PAR 36 screw max. 50W E 12V

Dimensions

L1210xB192xH90  
L760xB106xH20

Materials

aluminium 14 | 1M | 2M

Ref

1438.1M white tex  
1438.2M black tex  
1438.14 alu satin

built-up  
standard with mounting plate  
standard mit Deckenplatte



# INDOOR | Ceiling UP | Pendants | POLO

## W743.CH/.. - POLO

~230V



IP44



0,6 m



1,8800



0,5 m



05.20.02



pendant with chain and built-up base  
Pendelleuchte mit Kette und Aufbaubasis

### Lamp type

1x C35 E14 max. 40W A - E **230V**

### Dimensions

L160xB160xH160 - Chain 600

L70xB70

### Materials

INOX 32X | 46X | 53X | 63X | 64X | 31MX | 33MX  
INOX 316 5 | 5BB

### Ref

W743.CH.5	inox 316
W743.CH.5BB	inox 316 2x coated
W743.CH.31MX	white texture
W743.CH.32X	black texture
W743.CH.33MX	brown texture
W743.CH.46X	grey-brown
W743.CH.53X	bronze-brown
W743.CH.63X	umbra grey
W743.CH.64X	black grey

**built-up**  
longer chain on request  
längere Kette auf Anfrage

## W743.B.CH/.. - POLO

~230V



IP44



0,6 m



1,7000



0,5 m



05.20.02



pendant with chain and built-up base  
Pendelleuchte mit Kette und Aufbaubasis

### Lamp type

1x A60 E27 max. 40W A - E **230V**

### Dimensions

L160xB160xH160 - Chain 600

L70xB70

### Materials

INOX 32X | 46X | 53X | 63X | 64X | 31MX | 33MX  
INOX 316 5 | 5BB

### Ref

W743.B.CH.5	inox 316
W743.B.CH.5BB	inox 316 2x coated
W743.B.CH.31MX	white texture
W743.B.CH.32X	black texture
W743.B.CH.33MX	brown texture
W743.B.CH.46X	grey-brown
W743.B.CH.53X	bronze-brown
W743.B.CH.63X	umbra grey
W743.B.CH.64X	black grey

**built-up**  
longer chain on request  
längere Kette auf Anfrage

## W743.B3/.. - POLO

~230V



IP44



0,6 m



0,5 m



05.20.02



pendant with swivel and built-up base  
Pendelleuchte mit Kugelgelenk und Aufbaurosette

### Lamp type

1x C35 E14 max. 40W A - E **230V**

### Dimensions

L160xB160xH160 - Bar 600

L70xB70

### Materials

INOX 32X | 46X | 53X | 63X | 64X | 31MX | 33MX  
INOX 316 5 | 5BB

### Ref

W743.B3.5	inox 316
W743.B3.5BB	inox 316 2x coated
W743.B3.31MX	white texture
W743.B3.32X	black texture
W743.B3.33MX	brown texture
W743.B3.46X	grey-brown
W743.B3.53X	bronze-brown
W743.B3.63X	umbra grey
W743.B3.64X	black grey

**built-up**  
bar 500-700-800mm on request  
Stange 500-700-800mm auf Anfrage

## W743.B.B3/.. - POLO

~230V



IP44



0,6 m



2,1500



0,5 m



05.20.02



pendant with swivel and built-up base  
Pendelleuchte mit Kugelgelenk und Aufbaurosette

### Lamp type

1x A60 E27 max. 40W A - E **230V**

### Dimensions

L160xB160xH160 - Bar 600

L70xB70

### Materials

INOX 32X | 46X | 53X | 63X | 64X | 31MX | 33MX  
INOX 316 5 | 5BB

### Ref

W743.B.B3.5	inox 316
W743.B.B3.5BB	inox 316 2x coated
W743.B.B3.31MX	white texture
W743.B.B3.32X	black texture
W743.B.B3.33MX	brown texture
W743.B.B3.46X	grey-brown
W743.B.B3.53X	bronze-brown
W743.B.B3.63X	umbra grey
W743.B.B3.64X	black grey

**built-up**  
bar 500-700-800mm on request  
Stange 500-700-800mm auf Anfrage

PENDANTS





**W744.CH/.. - POLO**

~230V IP44 0,6 m 3,7400 0,5 m 05.20.02 CE



pendant with chain and built-up base  
Pendelleuchte mit Kette und Aufbaubasis

**Lamp type**  
1x QPAR 51 GU10 max. 20W **A+** - **E** **230V**

**Dimensions**  
L160xB160xH160 - Chain 600  
L70xB70

**Materials**  
INOX 32X | 46X | 53X | 63X | 64X | 31MX | 33MX  
INOX 316 5 | 5BB

**Ref**  
W744.CH.5 inox 316  
W744.CH.5BB inox 316 2x coated  
W744.CH.31MX white texture  
W744.CH.32X black texture  
W744.CH.33MX brown texture  
W744.CH.46X grey-brown  
W744.CH.53X bronze-brown  
W744.CH.63X umbra grey  
W744.CH.64X black grey

**built-up**  
longer chain on request  
längere Kette auf Anfrage

**W744.B3/.. - POLO**

~230V IP44 0,6 m 1,5300 0,5 m 05.20.02 CE



pendant with swivel and built-up base  
Pendelleuchte mit Kugelgelenk und Aufbaurosette

**Lamp type**  
1x QPAR 51 GU10 max. 20W **A+** - **E** **230V**

**Dimensions**  
L160xB160xH160 - Bar 600  
L70xB70

**Materials**  
INOX 32X | 46X | 53X | 63X | 64X | 31MX | 33MX  
INOX 316 5 | 5BB

**Ref**  
W744.B3.5 inox 316  
W744.B3.5BB inox 316 2x coated  
W744.B3.31MX white texture  
W744.B3.32X black texture  
W744.B3.33MX brown texture  
W744.B3.46X grey-brown  
W744.B3.53X bronze-brown  
W744.B3.63X umbra grey  
W744.B3.64X black grey

**built-up**  
bar 500-700-800mm on request  
Stange 500-700-800mm auf Anfrage

**W774.CH/.. - POLO**

~230V IP44 0,6 m 3,7850 0,5 m 05.20.02 CE



pendant with chain and built-up base  
Pendelleuchte mit Kette und Aufbaubasis

**Lamp type**  
1x A60 E27 max. 40W **A** - **E** **230V**

**Dimensions**  
L240xB240xH240 - Chain 600  
L70xB70

**Materials**  
INOX 32X | 46X | 53X | 63X | 64X | 31MX | 33MX  
INOX 316 5 | 5BB

**Ref**  
W774.CH.5 inox 316  
W774.CH.5BB inox 316 2x coated  
W774.CH.31MX white texture  
W774.CH.32X black texture  
W774.CH.33MX brown texture  
W774.CH.46X grey-brown  
W774.CH.53X bronze-brown  
W774.CH.63X umbra grey  
W774.CH.64X black grey

**built-up**  
longer chain on request  
längere Kette auf Anfrage

**W774.B3/.. - POLO**

~230V IP44 0,6 m 3,4800 0,5 m 05.20.02 CE



pendant with swivel and built-up base  
Pendelleuchte mit Kugelgelenk und Aufbaurosette

**Lamp type**  
1x A60 E27 max. 40W **A** - **E** **230V**

**Dimensions**  
L240xB240xH240 - Bar 600  
L70xB70

**Materials**  
INOX 32X | 46X | 53X | 63X | 64X | 31MX | 33MX  
INOX 316 5 | 5BB

**Ref**  
W774.B3.5 inox 316  
W774.B3.5BB inox 316 2x coated  
W774.B3.31MX white texture  
W774.B3.32X black texture  
W774.B3.33MX brown texture  
W774.B3.46X grey-brown  
W774.B3.53X bronze-brown  
W774.B3.63X umbra grey  
W774.B3.64X black grey

**built-up**  
bar 500-700-800mm on request  
Stange 500-700-800mm auf Anfrage



**W748.CH/.. - POLO**

~230V  IP44     0,6 m  3,6300  0,5 m  05.20.02  CE



pendant with chain and built-up base  
Pendelleuchte mit Kette und Aufbaubasis

**Lamp type**

1x A60 E27 max. 60W  A  E  E **230V**  
or 1x ST64 E27 max. 60W  A  E  E **230V**

**Dimensions**

L240xB240xH320 - Chain 600  
L70xB70

**Materials**

INOX 32X | 46X | 53X | 63X | 64X | 31MX | 33MX  
INOX 316 5 | 5BB

**Ref**

W748.CH.5	inox 316
W748.CH.5BB	inox 316 2x coated
W748.CH.31MX	white texture
W748.CH.32X	black texture
W748.CH.33MX	brown texture
W748.CH.46X	grey-brown
W748.CH.53X	bronze-brown
W748.CH.63X	umbra grey
W748.CH.64X	black grey

**built-up**  
longer chain on request  
längere Kette auf Anfrage

**W748.B3/.. - POLO**

~230V  IP44     0,6 m  4,7200  0,5 m  05.20.02  CE



pendant with swivel and built-up base  
Pendelleuchte mit Kugelgelenk und Aufbaurosette

**Lamp type**

1x A60 E27 max. 60W  A  E  E **230V**  
or 1x ST64 E27 max. 60W  A  E  E **230V**

**Dimensions**

L240xB240xH320 - Bar 600  
L70xB70

**Materials**

INOX 32X | 46X | 53X | 63X | 64X | 31MX | 33MX  
INOX 316 5 | 5BB

**Ref**

W748.B3.5	inox 316
W748.B3.5BB	inox 316 2x coated
W748.B3.31MX	white texture
W748.B3.32X	black texture
W748.B3.33MX	brown texture
W748.B3.46X	grey-brown
W748.B3.53X	bronze-brown
W748.B3.63X	umbra grey
W748.B3.64X	black grey

**built-up**  
bar 500-700-800mm on request  
Stange 500-700-800mm auf Anfrage

**W749.CH/.. - POLO**

~230V  IP44     0,6 m  6,0700  0,5 m  05.20.02  CE



pendant with chain and built-up base  
Pendelleuchte mit Kette und Aufbaubasis

**Lamp type**

1x A60 E27 max. 60W  A  E  E **230V**  
or 1x ST64 E27 max. 60W  A  E  E **230V**

**Dimensions**

L320xB320xH320 - Chain 600  
L70xB70

**Materials**

INOX 32X | 46X | 53X | 63X | 64X | 31MX | 33MX  
INOX 316 5 | 5BB

**Ref**

W749.CH.5	inox 316
W749.CH.5BB	inox 316 2x coated
W749.CH.31MX	white texture
W749.CH.32X	black texture
W749.CH.33MX	brown texture
W749.CH.46X	grey-brown
W749.CH.53X	bronze-brown
W749.CH.63X	umbra grey
W749.CH.64X	black grey

**built-up**  
longer chain on request  
längere Kette auf Anfrage

**W749.B3/.. - POLO**

~230V  IP44     0,6 m  5,6600  0,5 m  05.20.02  CE



pendant with swivel and built-up base  
Pendelleuchte mit Kugelgelenk und Aufbaurosette

**Lamp type**

1x A60 E27 max. 60W  A  E  E **230V**  
or 1x ST64 E27 max. 60W  A  E  E **230V**

**Dimensions**

L320xB320xH320 - Bar 600  
L70xB70

**Materials**

INOX 32X | 46X | 53X | 63X | 64X | 31MX | 33MX  
INOX 316 5 | 5BB

**Ref**

W749.B3.5	inox 316
W749.B3.5BB	inox 316 2x coated
W749.B3.31MX	white texture
W749.B3.32X	black texture
W749.B3.33MX	brown texture
W749.B3.46X	grey-brown
W749.B3.53X	bronze-brown
W749.B3.63X	umbra grey
W749.B3.64X	black grey

**built-up**  
bar 500-700-800mm on request  
Stange 500-700-800mm auf Anfrage

W758.CH/.. - POLO

~230V  IP44     0,6 m  8,6000  0,5 m  05.20.02 





pendant with chain and built-up base  
Pendelleuchte mit Kette und Aufbaubasis

Lamp type

 1x A60 E27 max. 60W  230V  
or  1x ST64 E27 max. 60W  230V

Dimensions

 L400xB400xH400 - Chain 600  
 L70xB70

Materials

INOX 32X | 46X | 53X | 63X | 64X | 31MX | 33MX  
INOX 316 5 | 5BB

Ref

W758.CH.5	inox 316
W758.CH.5BB	inox 316 2x coated
W758.CH.31MX	white texture
W758.CH.32X	black texture
W758.CH.33MX	brown texture
W758.CH.46X	grey-brown
W758.CH.53X	bronze-brown
W758.CH.63X	umbra grey
W758.CH.64X	black grey

built-up  
longer chain on request  
längere Kette auf Anfrage

W758.B3/.. - POLO

~230V  IP44     0,6 m  7,5800  0,5 m  05.20.02 





pendant with swivel and built-up base  
Pendelleuchte mit Kugelgelenk und Aufbaurosette

Lamp type

 1x A60 E27 max. 60W  230V  
or  1x ST64 E27 max. 60W  230V

Dimensions

 L400xB400xH400 - Bar 600  
 L70xB70

Materials

INOX 32X | 46X | 53X | 63X | 64X | 31MX | 33MX  
INOX 316 5 | 5BB

Ref

W758.B3.5	inox 316
W758.B3.5BB	inox 316 2x coated
W758.B3.31MX	white texture
W758.B3.32X	black texture
W758.B3.33MX	brown texture
W758.B3.46X	grey-brown
W758.B3.53X	bronze-brown
W758.B3.63X	umbra grey
W758.B3.64X	black grey

built-up  
bar 500-700-800mm on request  
Stange 500-700-800mm auf Anfrage



W759.CH/.. - POLO

~230V  IP44     0,6 m  8,9000  0,5 m  05.20.50 





pendant with chain and built-up base - with Xicato LED IP66  
- with LED driver  
Pendelleuchte mit Kette und Aufbaubasis - mit LED-Modul  
Xicato IP66 - mit Driver LED

Lamp type

 1x Led 2220lm CRI80 max. 29W  700mA

Dimensions

 L400xB400xH400 - Chain 600  
 L70xB70

Ref

W759.CH.5	NW
W759.CH.5BB	NW
W759.CH.31MX	NW
W759.CH.32X	NW
W759.CH.33MX	NW
W759.CH.46X	NW
W759.CH.53X	NW
W759.CH.63X	NW
W759.CH.64X	NW

built-up  
longer chain on request  
längere Kette auf Anfrage  
other LED colours on request  
andere LED-Farben auf Anfrage



W759.B3/.. - POLO

~230V  IP44     0,6 m  8,5000  0,5 m  05.20.50 





pendant with swivel and built-up base - with Xicato LED IP66  
- with LED driver  
Pendelleuchte mit Kugelgelenk und Aufbaurosette - mit LED-  
Modul Xicato IP66 - mit Driver LED

Lamp type

 1x Led 2220lm CRI80 max. 29W  700mA

Dimensions

 L400xB400xH400 - Bar 600  
 L70xB70

Ref

W759.B3.5	NW
W759.B3.5BB	NW
W759.B3.31MX	NW
W759.B3.32X	NW
W759.B3.33MX	NW
W759.B3.46X	NW
W759.B3.53X	NW
W759.B3.63X	NW
W759.B3.64X	NW

built-up  
bar 500-700-800mm on request  
Stange 500-700-800mm auf Anfrage  
other LED colours on request  
andere LED-Farben auf Anfrage

W805.B3/.. - POLO - B3

~230V IP44 0,6 m 0,5 m 05.20.02 CE



pendant with swivel and built-up base  
Pendelleuchte mit Kugelgelenk und Aufbaurosette

Lamp type

1x G125 E27 max. 8W **A** - **E** 230V  
1x ST64 E27 max. 40W **A** - **E** 230V

Dimensions

L600xB600xH410 - Bar 600  
L70xB70

Materials

INOX 32X | 46X | 53X | 63X | 64X | 31MX | 33MX  
INOX 316 5 | 5BB

Ref

W805.B3.5	inox 316
W805.B3.5BB	inox 316 2x coated
W805.B3.31MX	white texture
W805.B3.32X	black texture
W805.B3.33MX	brown texture
W805.B3.46X	grey-brown
W805.B3.53X	bronze-brown
W805.B3.63X	umbra grey
W805.B3.64X	black grey

built-up

W745.CH/.. - POLO

~230V IP44 0,6 m 3,0900 0,5 m 05.20.02 CE



pendant with chain and built-up base  
Pendelleuchte mit Kette und Aufbaubasis

Lamp type

1x A60 E27 max. 60W **A** - **E** 230V  
or 1x ST64 E27 max. 60W **A** - **E** 230V

Dimensions

L128xB128xH320 - Chain 600  
L70xB70

Materials

INOX 32X | 46X | 53X | 63X | 64X | 31MX | 33MX  
INOX 316 5 | 5BB

Ref

W745.CH.5	inox 316
W745.CH.5BB	inox 316 2x coated
W745.CH.31MX	white texture
W745.CH.32X	black texture
W745.CH.33MX	brown texture
W745.CH.46X	grey-brown
W745.CH.53X	bronze-brown
W745.CH.63X	umbra grey
W745.CH.64X	black grey

built-up

longer chain on request  
längere Kette auf Anfrage

W745.B3/.. - POLO

~230V IP44 0,6 m 3,5200 0,5 m 05.20.02 CE



pendant with swivel and built-up base  
Pendelleuchte mit Kugelgelenk und Aufbaurosette

Lamp type

1x A60 E27 max. 60W **A** - **E** 230V  
or 1x ST64 E27 max. 60W **A** - **E** 230V

Dimensions

L128xB128xH320 - Bar 600  
L70xB70

Materials

INOX 32X | 46X | 53X | 63X | 64X | 31MX | 33MX  
INOX 316 5 | 5BB

Ref

W745.B3.5	inox 316
W745.B3.5BB	inox 316 2x coated
W745.B3.31MX	white texture
W745.B3.32X	black texture
W745.B3.33MX	brown texture
W745.B3.46X	grey-brown
W745.B3.53X	bronze-brown
W745.B3.63X	umbra grey
W745.B3.64X	black grey

built-up

bar 500-700-800mm on request  
Stange 500-700-800mm auf Anfrage

W775.CH/.. - POLO

~230V IP44 0,6 m 2,0000 0,5 m 05.20.02 CE



pendant with chain and built-up base  
Pendelleuchte mit Kette und Aufbaubasis

Lamp type

1x D45 E40 max. 40W **A** - **E** 230V

Dimensions

L136xB136xH180 - Chain 600  
L70xB70

Materials

INOX 32X | 46X | 53X | 63X | 64X | 31MX | 33MX  
INOX 316 5 | 5BB

Ref

W775.CH.5	inox 316
W775.CH.5BB	inox 316 2x coated
W775.CH.31MX	white texture
W775.CH.32X	black texture
W775.CH.33MX	brown texture
W775.CH.46X	grey-brown
W775.CH.53X	bronze-brown
W775.CH.63X	umbra grey
W775.CH.64X	black grey

built-up

longer chain on request  
längere Kette auf Anfrage

# INDOOR | Ceiling UP | Pendants | POLO

## W775.B.CH/.. - POLO

~230V IP44 0,6 m 2,1850 0,5 m 05.20.02 CE



pendant with chain and built-up base  
Pendelleuchte mit Kette und Aufbaubasis

### Lamp type

1x A60 E27 max. 40W **A** - **E** 230V

### Dimensions

L136xB136xH180 - Chain 600  
L70xB70

### Materials

INOX 32X | 46X | 53X | 63X | 64X | 31MX | 33MX  
INOX 316 5 | 5BB

### Ref

W775.B.CH.5	inox 316
W775.B.CH.5BB	inox 316 2x coated
W775.B.CH.31MX	white texture
W775.B.CH.32X	black texture
W775.B.CH.33MX	brown texture
W775.B.CH.46X	grey-brown
W775.B.CH.53X	bronze-brown
W775.B.CH.63X	umbra grey
W775.B.CH.64X	black grey

**built-up**  
longer chain on request  
längere Kette auf Anfrage

## W775.B3/.. - POLO

~230V IP44 0,6 m 2,6100 0,5 m 05.20.02 CE



pendant with swivel and built-up base  
Pendelleuchte mit Kugelgelenk und Aufbaurosette

### Lamp type

1x D45 E40 max. 40W **A** - **E** 230V

### Dimensions

L136xB136xH180 - Bar 600  
L70xB70

### Materials

INOX 32X | 46X | 53X | 63X | 64X | 31MX | 33MX  
INOX 316 5 | 5BB

### Ref

W775.B3.5	inox 316
W775.B3.5BB	inox 316 2x coated
W775.B3.31MX	white texture
W775.B3.32X	black texture
W775.B3.33MX	brown texture
W775.B3.46X	grey-brown
W775.B3.53X	bronze-brown
W775.B3.63X	umbra grey
W775.B3.64X	black grey

**built-up**  
bar 500-700-800mm on request  
Stange 500-700-800mm auf Anfrage

## W775.B.B3/.. - POLO

~230V IP44 0,6 m 0,5 m 05.20.02 CE



pendant with swivel and built-up base  
Pendelleuchte mit Kugelgelenk und Aufbaurosette

### Lamp type

1x A60 E27 max. 40W **A** - **E** 230V

### Dimensions

L136xB136xH180 - Bar 600  
L70xB70

### Materials

INOX 32X | 46X | 53X | 63X | 64X | 31MX | 33MX  
INOX 316 5 | 5BB

### Ref

W775.B.B3.5	inox 316
W775.B.B3.5BB	inox 316 2x coated
W775.B.B3.31MX	white texture
W775.B.B3.32X	black texture
W775.B.B3.33MX	brown texture
W775.B.B3.46X	grey-brown
W775.B.B3.53X	bronze-brown
W775.B.B3.63X	umbra grey
W775.B.B3.64X	black grey

**built-up**  
bar 500-700-800mm on request  
Stange 500-700-800mm auf Anfrage

## W776.CH/.. - POLO

~230V IP44 0,6 m 0,5 m 05.20.02 CE



pendant with chain and built-up base  
Pendelleuchte mit Kette und Aufbaubasis

### Lamp type

1x QPAR 51 GU10 max. 20W **A** - **E** 230V

### Dimensions

L136xB136xH180 - Chain 600  
L70xB70

### Materials

INOX 32X | 46X | 53X | 63X | 64X | 31MX | 33MX  
INOX 316 5 | 5BB

### Ref

W776.CH.5	inox 316
W776.CH.5BB	inox 316 2x coated
W776.CH.31MX	white texture
W776.CH.32X	black texture
W776.CH.33MX	brown texture
W776.CH.46X	grey-brown
W776.CH.53X	bronze-brown
W776.CH.63X	umbra grey
W776.CH.64X	black grey

**built-up**  
longer chain on request  
längere Kette auf Anfrage



**W776.B3/.. - POLO**

~230V IP44 0,6 m 0,5 m 05.20.02 CE



pendant with swivel and built-up base  
Pendelleuchte mit Kugelgelenk und Aufbaurosette

<b>Lamp type</b>	1x QPAR 51 GU10 max. 20W <b>A</b> - <b>E</b>	230V
<b>Dimensions</b>	L136xB136xH180 - Bar 600	
	L70xB70	
<b>Materials</b>	INOX 32X   46X   53X   63X   64X   31MX   33MX	
	INOX 316 5   5BB	

<b>Ref</b>	W776.B3.5	inox 316
	W776.B3.5BB	inox 316 2x coated
	W776.B3.31MX	white texture
	W776.B3.32X	black texture
	W776.B3.33MX	brown texture
	W776.B3.46X	grey-brown
	W776.B3.53X	bronze-brown
	W776.B3.63X	umbra grey
	W776.B3.64X	black grey

**built-up**  
bar 400-600-700-800mm on request  
Stange 400-600-700-800mm auf Anfrage

**W746.CH/.. - POLO**

~230V IP44 0,6 m 6,3200 0,5 m 05.20.02 CE



pendant with chain and built-up base  
Pendelleuchte mit Kette und Aufbaubasis

<b>Lamp type</b>	1x A60 E27 max. 60W <b>A</b> - <b>E</b>	230V
or	1x ST64 E27 max. 60W <b>A</b> - <b>E</b>	230V
<b>Dimensions</b>	L240xB240xH320 - Chain 600	
	L70xB70	
<b>Materials</b>	INOX 32X   46X   53X   63X   64X   31MX   33MX	
	INOX 316 5   5BB	

<b>Ref</b>	W746.CH.5	inox 316
	W746.CH.5BB	inox 316 2x coated
	W746.CH.31MX	white texture
	W746.CH.32X	black texture
	W746.CH.33MX	brown texture
	W746.CH.46X	grey-brown
	W746.CH.53X	bronze-brown
	W746.CH.63X	umbra grey
	W746.CH.64X	black grey

**built-up**  
longer chain on request  
längere Kette auf Anfrage

**W746.B3/.. - POLO**

~230V IP44 0,6 m 5,8550 0,5 m 05.20.02 CE



pendant with swivel and built-up base  
Pendelleuchte mit Kugelgelenk und Aufbaurosette

<b>Lamp type</b>	1x A60 E27 max. 60W <b>A</b> - <b>E</b>	230V
or	1x ST64 E27 max. 60W <b>A</b> - <b>E</b>	230V
<b>Dimensions</b>	L240xB240xH320 - Bar 600	
	L70xB70	
<b>Materials</b>	INOX 32X   46X   53X   63X   64X   31MX   33MX	
	INOX 316 5   5BB	

<b>Ref</b>	W746.B3.5	inox 316
	W746.B3.5BB	inox 316 2x coated
	W746.B3.31MX	white texture
	W746.B3.32X	black texture
	W746.B3.33MX	brown texture
	W746.B3.46X	grey-brown
	W746.B3.53X	bronze-brown
	W746.B3.63X	umbra grey
	W746.B3.64X	black grey

**built-up**  
bar 500-700-800mm on request  
Stange 500-700-800mm auf Anfrage

**W747.CH/.. - POLO**

~230V IP44 0,6 m 7,4950 0,5 m 05.20.02 CE



pendant with chain and built-up base  
Pendelleuchte mit Kette und Aufbaubasis

<b>Lamp type</b>	1x A60 E27 max. 60W <b>A</b> - <b>E</b>	230V
or	1x ST64 E27 max. 60W <b>A</b> - <b>E</b>	230V
<b>Dimensions</b>	L300xB300xH320 - Chain 600	
	L70xB70	
<b>Materials</b>	INOX 32X   46X   53X   63X   64X   31MX   33MX	
	INOX 316 5   5BB	

<b>Ref</b>	W747.CH.5	inox 316
	W747.CH.5BB	inox 316 2x coated
	W747.CH.31MX	white texture
	W747.CH.32X	black texture
	W747.CH.33MX	brown texture
	W747.CH.46X	grey-brown
	W747.CH.53X	bronze-brown
	W747.CH.63X	umbra grey
	W747.CH.64X	black grey

**built-up**  
longer chain on request  
längere Kette auf Anfrage

W747.B3/.. - POLO

~230V IP44 0,6 m 6,4950 0,5 m 05.20.02 CE



pendant with swivel and built-up base  
Pendelleuchte mit Kugelgelenk und Aufbaurosette

Lamp type

1x A60 E27 max. 60W **A** - **E** 230V  
or 1x ST64 E27 max. 60W **A** - **E** 230V

Dimensions

L300xB300xH320 - Bar 600  
L70xB70

Materials

INOX 32X | 46X | 53X | 63X | 64X | 31MX | 33MX  
INOX 316 5 | 5BB

Ref

W747.B3.5	inox 316
W747.B3.5BB	inox 316 2x coated
W747.B3.31MX	white texture
W747.B3.32X	black texture
W747.B3.33MX	brown texture
W747.B3.46X	grey-brown
W747.B3.53X	bronze-brown
W747.B3.63X	umbra grey
W747.B3.64X	black grey

**built-up**  
bar 500-700-800mm on request  
Stange 500-700-800mm auf Anfrage

W747.2.CH/.. - POLO

~230V IP44 0,6 m 5,9000 0,5 m 05.20.02 CE



pendant with chain and built-up base  
Pendelleuchte mit Kette und Aufbaubasis

Lamp type

2x A60 E27 max. 60W **A** - **E** 230V  
or 2x ST64 E27 max. 60W **A** - **E** 230V

Dimensions

L300xB300xH320 - Chain 600  
L70xB70

Materials

INOX 32X | 46X | 53X | 63X | 64X | 31MX | 33MX  
INOX 316 5 | 5BB

Ref

W747.2.CH.5	inox 316
W747.2.CH.5BB	inox 316 2x coated
W747.2.CH.31MX	white texture
W747.2.CH.32X	black texture
W747.2.CH.33MX	brown texture
W747.2.CH.46X	grey-brown
W747.2.CH.53X	bronze-brown
W747.2.CH.63X	umbra grey
W747.2.CH.64X	black grey

**built-up**  
longer chain on request  
längere Kette auf Anfrage

W747.2.B3/.. - POLO

~230V IP44 0,6 m 0,5 m 05.20.02 CE



pendant with swivel and built-up base  
Pendelleuchte mit Kugelgelenk und Aufbaurosette

Lamp type

2x A60 E27 max. 60W **A** - **E** 230V  
or 2x ST64 E27 max. 60W **A** - **E** 230V

Dimensions

L300xB300xH320 - Bar 600  
L70xB70

Materials

INOX 32X | 46X | 53X | 63X | 64X | 31MX | 33MX  
INOX 316 5 | 5BB

Ref

W747.2.B3.5	inox 316
W747.2.B3.5BB	inox 316 2x coated
W747.2.B3.31MX	white texture
W747.2.B3.32X	black texture
W747.2.B3.33MX	brown texture
W747.2.B3.46X	grey-brown
W747.2.B3.53X	bronze-brown
W747.2.B3.63X	umbra grey
W747.2.B3.64X	black grey

**built-up**  
bar 500-700-800mm on request  
Stange 500-700-800mm auf Anfrage



5104.2.SO/.. - TAVOLO B160 L600

~230V IP20 0,6 m 0,5 m 05.20.02 CE



pendant with swivel - with top plate open  
Pendelleuchte mit Kugelgelenk - mit Oberplatte offen

Lamp type

2x ST64 E27 max. 40W **A** - **E** 230V  
or 2x G80 E27 max. 40W **A** - **E** 230V

Dimensions

L600xB160xH250 - Bar 600  
L400xB40

Materials

INOX 32X | 46X | 53X | 31MX

Ref

5104.2.SO.31MX white texture  
5104.2.SO.32X black texture  
5104.2.SO.46X grey-brown  
5104.2.SO.53X bronze-brown

built-up

5104.3X.SO/.. - TAVOLO B160 L600

~230V IP20 0,6 m 0,5 m 05.20.02 CE



pendant with swivel - with top plate open  
Pendelleuchte mit Kugelgelenk - mit Oberplatte offen

Lamp type

3x ST64 E27 max. 40W **A** - **E** 230V  
or 3x G80 E27 max. 40W **A** - **E** 230V

Dimensions

L600xB160xH250 - Bar 600  
L400xB40

Materials

INOX 32X | 46X | 53X | 31MX

Ref

5104.3X.SO.31MX white texture  
5104.3X.SO.32X black texture  
5104.3X.SO.46X grey-brown  
5104.3X.SO.53X bronze-brown

built-up

5104.3.SO/.. - TAVOLO B160 L800

~230V IP20 0,6 m 0,5 m 05.20.02 CE



pendant with swivel - with top plate open  
Pendelleuchte mit Kugelgelenk - mit Oberplatte offen

Lamp type

3x ST64 E27 max. 40W **A** - **E** 230V  
or 3x G80 E27 max. 40W **A** - **E** 230V

Dimensions

L800xB160xH250 - Bar 600  
L600xB40

Materials

INOX 32X | 46X | 53X | 31MX

Ref

5104.3.SO.31MX white texture  
5104.3.SO.32X black texture  
5104.3.SO.46X grey-brown  
5104.3.SO.53X bronze-brown

built-up

5104.4.SO/.. - TAVOLO B160 L1000

~230V IP20 0,6 m 14,3500 0,5 m 05.20.02 CE



pendant with swivel - with top plate open  
Pendelleuchte mit Kugelgelenk - mit Oberplatte offen

Lamp type

4x ST64 E27 max. 40W **A** - **E** 230V  
or 4x G80 E27 max. 40W **A** - **E** 230V

Dimensions

L1000xB160xH250 - Bar 600  
L600xB40

Materials

INOX 32X | 46X | 53X | 31MX

Ref

5104.4.SO.31MX white texture  
5104.4.SO.32X black texture  
5104.4.SO.46X grey-brown  
5104.4.SO.53X bronze-brown

built-up

5104.5.SO/.. - TAVOLO B160 L1200

~230V



IP20



0,6 m



13,4500



0,5 m



pendant with swivel - with top plate open  
 Pendelleuchte mit Kugelgelenk - mit Oberplatte offen

**Lamp type**

5x ST64 E27 max. 40W A - E 230V

or 5x G80 E27 max. 40W A - E 230V

**Dimensions**

L1200xB160xH250 - Bar 600

L600xB40

**Materials**

INOX

32X | 46X | 53X | 31MX

**Ref**

5104.5.SO.31MX

white texture

5104.5.SO.32X

black texture

5104.5.SO.46X

grey-brown

5104.5.SO.53X

bronze-brown

built-up

PENDANTS





5103.2.SC/.. - TAVOLO B160 L600

~230V IP20     0,6 m   



pendant with swivel - with top plate closed  
Pendelleuchte mit Kugelgelenk - mit Oberplatte geschlossen

Lamp type

2x ST64 E27 max. 40W  230V  
or 2x G80 E27 max. 40W  230V

Dimensions

L600xB160xH250 - Bar 600  
L400xB40

Materials

INOX 32X | 46X | 53X | 31MX

Ref

5103.2.SC.31MX white texture  
5103.2.SC.32X black texture  
5103.2.SC.46X grey-brown  
5103.2.SC.53X bronze-brown

built-up

5103.3X.SC/.. - TAVOLO B160 L600

~230V IP20     0,6 m   



pendant with swivel - with top plate closed  
Pendelleuchte mit Kugelgelenk - mit Oberplatte geschlossen

Lamp type

3x ST64 E27 max. 40W  230V  
or 3x G80 E27 max. 40W  230V

Dimensions

L600xB160xH250 - Bar 600  
L400xB40

Materials

INOX 32X | 46X | 53X | 31MX

Ref

5103.3X.SC.31MX white texture  
5103.3X.SC.32X black texture  
5103.3X.SC.46X grey-brown  
5103.3X.SC.53X bronze-brown

built-up

5103.3.SC/.. - TAVOLO B160 L800

~230V IP20     0,6 m    



pendant with swivel - with top plate closed  
Pendelleuchte mit Kugelgelenk - mit Oberplatte geschlossen

Lamp type

3x ST64 E27 max. 40W  230V  
or 3x G80 E27 max. 40W  230V

Dimensions

L800xB160xH250 - Bar 600  
L600xB40

Materials

INOX 32X | 46X | 53X | 31MX

Ref

5103.3.SC.31MX white texture  
5103.3.SC.32X black texture  
5103.3.SC.46X grey-brown  
5103.3.SC.53X bronze-brown

built-up

5103.4.SC/.. - TAVOLO B160 L1000

~230V IP20     0,6 m    



pendant with swivel - with top plate closed  
Pendelleuchte mit Kugelgelenk - mit Oberplatte geschlossen

Lamp type

4x ST64 E27 max. 40W  230V  
or 4x G80 E27 max. 40W  230V

Dimensions

L1000xB160xH250 - Bar 600  
L600xB40

Materials

INOX 32X | 46X | 53X | 31MX

Ref

5103.4.SC.31MX white texture  
5103.4.SC.32X black texture  
5103.4.SC.46X grey-brown  
5103.4.SC.53X bronze-brown

built-up

5103.5.SC/.. - TAVOLO B160 L1200

~230V



IP20



0,6 m



17,000



0,5 m



pendant with swivel - with top plate closed  
 Pendelleuchte mit Kugelgelenk - mit Oberplatte geschlossen

Lamp type

5x ST64 E27 max. 40W A - E 230V

or 5x G80 E27 max. 40W A - E 230V

Dimensions

L1200xB160xH250 - Bar 600

L600xB40

Materials

INOX

32X | 46X | 53X | 31MX

Ref

5103.5.SC.31MX

white texture

5103.5.SC.32X

black texture

5103.5.SC.46X

grey-brown

5103.5.SC.53X

bronze-brown

built-up

PENDANTS

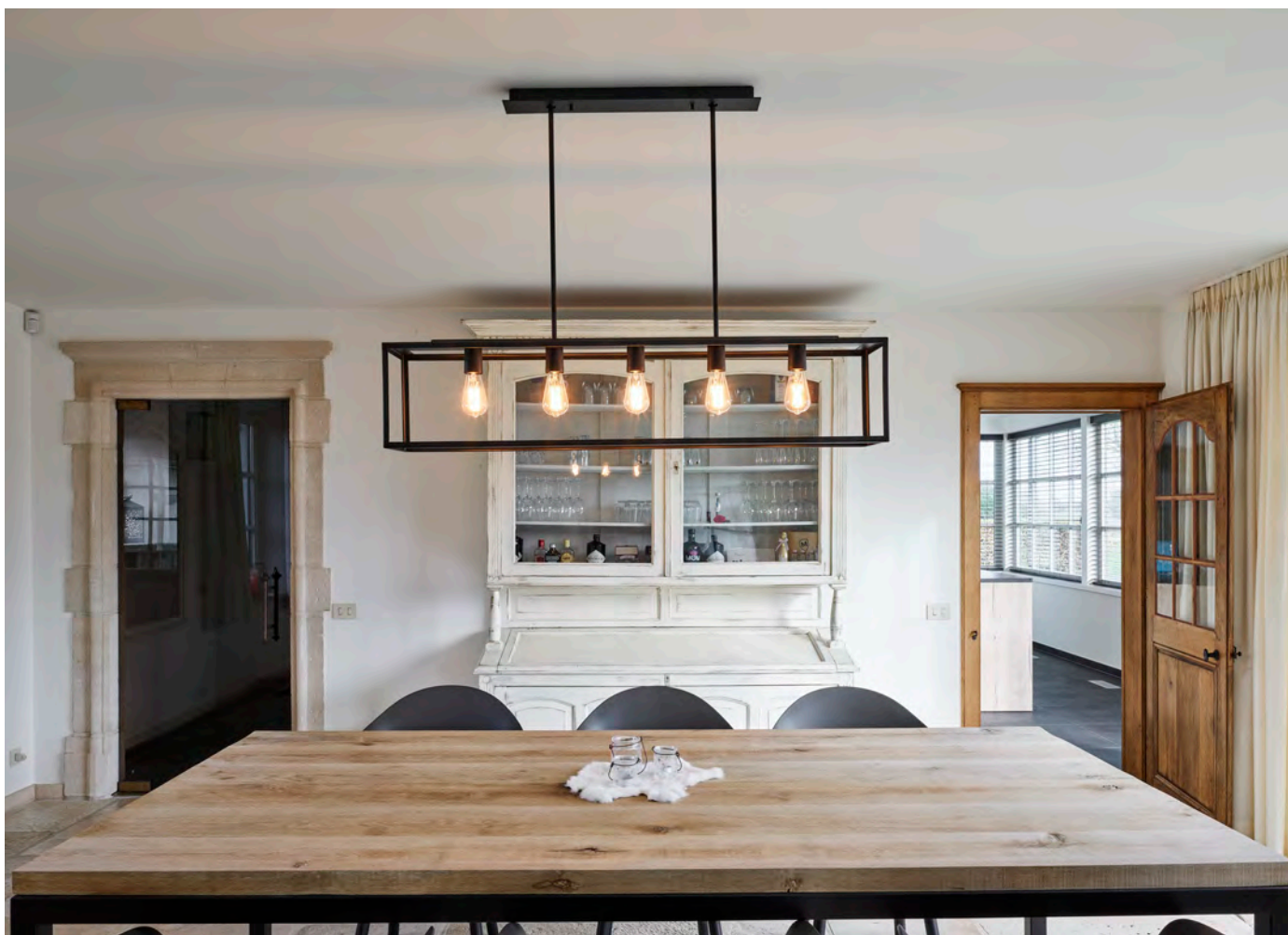

5101.2.XLO/.. - TAVOLO B200 L600

~230V IP20 0,6 m 0,5 m 05.20.02 CE



pendant with swivel - with top plate open  
 Pendelleuchte mit Kugelgelenk - mit Oberplatte offen

Lamp type

2x ST64 E27 max. 40W **A** - **E** 230V  
 or 2x G80 E27 max. 40W **A** - **E** 230V

Dimensions

L600xB200xH250 - Bar 600  
 L400xB40

Materials

INOX 32X | 46X | 53X | 31MX

Ref

5101.2.XLO.31MX white texture  
 5101.2.XLO.32X black texture  
 5101.2.XLO.46X grey-brown  
 5101.2.XLO.53X bronze-brown

built-up

5101.3X.XLO/.. - TAVOLO B200 L600

~230V IP20 0,6 m 10,1700 0,5 m 05.20.02 CE

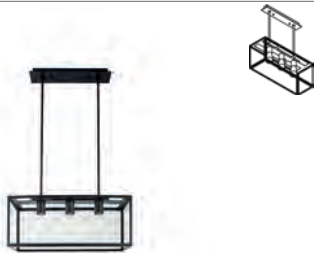

pendant with swivel - with top plate open  
 Pendelleuchte mit Kugelgelenk - mit Oberplatte offen

Lamp type

3x ST64 E27 max. 40W **A** - **E** 230V  
 or 3x G80 E27 max. 40W **A** - **E** 230V

Dimensions

L600xB200xH250 - Bar 600  
 L400xB40

Materials

INOX 32X | 46X | 53X | 31MX

Ref

5101.3X.XLO.31MX white texture  
 5101.3X.XLO.32X black texture  
 5101.3X.XLO.46X grey-brown  
 5101.3X.XLO.53X bronze-brown

built-up

5101.3.XLO/.. - TAVOLO B200 L800

~230V IP20 0,6 m 11,8000 0,5 m 05.20.02 CE



pendant with swivel - with top plate open  
 Pendelleuchte mit Kugelgelenk - mit Oberplatte offen

Lamp type

3x ST64 E27 max. 40W **A** - **E** 230V  
 or 3x G80 E27 max. 40W **A** - **E** 230V

Dimensions

L800xB200xH250 - Bar 600  
 L600xB40

Materials

INOX 32X | 46X | 53X | 31MX

Ref

5101.3.XLO.31MX white texture  
 5101.3.XLO.32X black texture  
 5101.3.XLO.46X grey-brown  
 5101.3.XLO.53X bronze-brown

built-up

5101.4.XLO/.. - TAVOLO B200 L1000

~230V IP20 0,6 m 14,2000 0,5 m 05.20.02 CE

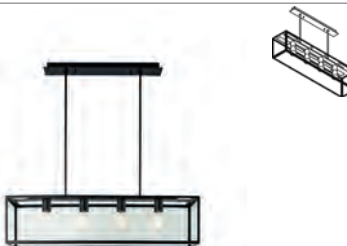

pendant with swivel - with top plate open  
 Pendelleuchte mit Kugelgelenk - mit Oberplatte offen

Lamp type

4x ST64 E27 max. 40W **A** - **E** 230V  
 or 4x G80 E27 max. 40W **A** - **E** 230V

Dimensions

L1000xB200xH250 - Bar 600  
 L600xB40

Materials

INOX 32X | 46X | 53X | 31MX

Ref

5101.4.XLO.31MX white texture  
 5101.4.XLO.32X black texture  
 5101.4.XLO.46X grey-brown  
 5101.4.XLO.53X bronze-brown

built-up

5101.5.XLO/.. - TAVOLO B200 L 1200

~230V IP20 0,6 m 13,7800 0,5 m 05.20.02 CE



pendant with swivel - with top plate open  
 Pendelleuchte mit Kugelgelenk - mit Oberplatte offen

Lamp type

5x ST64 E27 max. 60W A - E 230V  
 or 5x G80 E27 max. 40W A - E 230V

Dimensions

L1200xB200xH250 - Bar 600  
 L600xB40

Materials

INOX 32X | 46X | 53X | 31MX

Ref

5101.5.XLO.31MX white texture  
 5101.5.XLO.32X black texture  
 5101.5.XLO.46X grey-brown  
 5101.5.XLO.53X bronze-brown

built-up

5101.7.XLO/.. - TAVOLO B200 L 1500

~230V IP20 0,6 m 20,1000 0,5 m 05.20.02 CE

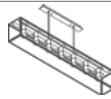

pendant with swivel - with top plate open  
 Pendelleuchte mit Kugelgelenk - mit Oberplatte offen

Lamp type

7x ST64 E27 max. 60W A - E 230V  
 or 7x G80 E27 max. 40W A - E 230V

Dimensions

L1500xB200xH250 - Bar 600  
 L600xB40

Materials

INOX 32X | 46X | 53X | 31MX

Ref

5101.7.XLO.31MX white texture  
 5101.7.XLO.32X black texture  
 5101.7.XLO.46X grey-brown  
 5101.7.XLO.53X bronze-brown

built-up





5100.2.XLC/.. - TAVOLO B200 L600

~230V IP20 0,6 m 0,5 m 05.20.02 CE



pendant with swivel - with top plate closed  
Pendelleuchte mit Kugelgelenk - mit Oberplatte geschlossen

Lamp type

2x ST64 E27 max. 40W **A** - **E** 230V  
or 2x G80 E27 max. 40W **A** - **E** 230V

Dimensions

L600xB200xH250 - Bar 600  
L400xB40

Materials

INOX 32X | 46X | 53X | 31MX

Ref

5100.2.XLC.31MX white texture  
5100.2.XLC.32X black texture  
5100.2.XLC.46X grey-brown  
5100.2.XLC.53X bronze-brown

built-up

5100.3X.XLC/.. - TAVOLO B200 L600

~230V IP20 0,6 m 11,1100 0,5 m 05.20.02 CE



pendant with swivel - with top plate closed  
Pendelleuchte mit Kugelgelenk - mit Oberplatte geschlossen

Lamp type

3x ST64 E27 max. 40W **A** - **E** 230V  
or 3x G80 E27 max. 40W **A** - **E** 230V

Dimensions

L600xB200xH250 - Bar 600  
L400xB40

Materials

INOX 32X | 46X | 53X | 31MX

Ref

5100.3X.XLC.31MX white texture  
5100.3X.XLC.32X black texture  
5100.3X.XLC.46X grey-brown  
5100.3X.XLC.53X bronze-brown

built-up

5100.3.XLC/.. - TAVOLO B200 L800

~230V IP20 0,6 m 13,1000 0,5 m 05.20.02 CE



pendant with swivel - with top plate closed  
Pendelleuchte mit Kugelgelenk - mit Oberplatte geschlossen

Lamp type

3x ST64 E27 max. 40W **A** - **E** 230V  
or 3x G80 E27 max. 40W **A** - **E** 230V

Dimensions

L800xB200xH250 - Bar 600  
L600xB40

Materials

INOX 32X | 46X | 53X | 31MX

Ref

5100.3.XLC.31MX white texture  
5100.3.XLC.32X black texture  
5100.3.XLC.46X grey-brown  
5100.3.XLC.53X bronze-brown

built-up

5100.4.XLC/.. - TAVOLO B200 L1000

~230V IP20 0,6 m 16,2500 0,5 m 05.20.02 CE



pendant with swivel - with top plate closed  
Pendelleuchte mit Kugelgelenk - mit Oberplatte geschlossen

Lamp type

4x ST64 E27 max. 40W **A** - **E** 230V  
or 4x G80 E27 max. 40W **A** - **E** 230V

Dimensions

L1000xB200xH250 - Bar 600  
L600xB40

Materials

INOX 32X | 46X | 53X | 31MX

Ref

5100.4.XLC.31MX white texture  
5100.4.XLC.32X black texture  
5100.4.XLC.46X grey-brown  
5100.4.XLC.53X bronze-brown

built-up

5100.5.XLC/.. - TAVOLO B200 L1200

~230V

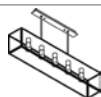

pendant with swivel - with top plate closed  
 Pendelleuchte mit Kugelgelenk - mit Oberplatte geschlossen

Lamp type

5x ST64 E27 max. 40W A - E 230V  
 or 5x G80 E27 max. 40W A - E 230V

Dimensions

L1200xB200xH250 - Bar 600  
 L600xB40

Materials

INOX 32X | 46X | 53X | 31MX

Ref

5100.5.XLC.31MX white texture  
 5100.5.XLC.32X black texture  
 5100.5.XLC.46X grey-brown  
 5100.5.XLC.53X bronze-brown

built-up

PENDANTS

5100.7.XLC/.. - TAVOLO B200 L1500

~230V

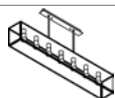

pendant with swivel - with top plate closed  
 Pendelleuchte mit Kugelgelenk - mit Oberplatte geschlossen

Lamp type

7x ST64 E27 max. 40W A - E 230V  
 or 7x G80 E27 max. 40W A - E 230V

Dimensions

L1500xB200xH250 - Bar 600  
 L600xB40

Materials

INOX 32X | 46X | 53X | 31MX

Ref

5100.7.XLC.31MX white texture  
 5100.7.XLC.32X black texture  
 5100.7.XLC.46X grey-brown  
 5100.7.XLC.53X bronze-brown

built-up



5105.3/.. - TAVOLO L1200

~230V IP20 0,6 m 0,5 m 05.20.02 CE



pendant with swivel - with top plate closed  
 Pendelleuchte mit Kugelgelenk - mit Oberplatte geschlossen

**Lamp type**  
 3x ST64 E27 max. 40W A - E 230V  
 or 3x G80 E27 max. 40W A - E 230V

**Dimensions**  
 L1200xB320xH300 - Bar 600  
 L600xB40

**Materials**  
 INOX 32X | 46X | 53X | 31MX

**Ref**  
 5105.3.31MX white texture  
 5105.3.32X black texture  
 5105.3.46X grey-brown  
 5105.3.53X bronze-brown

built-up

5105.5/.. - TAVOLO L1200

~230V IP20 0,6 m 17,8000 0,5 m 05.20.02 CE

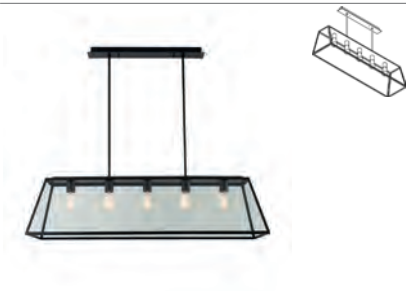

pendant with swivel - with top plate closed  
 Pendelleuchte mit Kugelgelenk - mit Oberplatte geschlossen

**Lamp type**  
 5x ST64 E27 max. 40W A - E 230V  
 or 5x G80 E27 max. 40W A - E 230V

**Dimensions**  
 L1200xB320xH300 - Bar 600  
 L600xB40

**Materials**  
 INOX 32X | 46X | 53X | 31MX

**Ref**  
 5105.5.31MX white texture  
 5105.5.32X black texture  
 5105.5.46X grey-brown  
 5105.5.53X bronze-brown

built-up



PENDANTS



5107.5.B3/.. - TAVOLO SQ 600X600 - B3

~230V IP20 0,6 m 14,4900 0,5 m 05.20.02 CE



pendant with swivel and built-up base  
Pendelleuchte mit Kugelgelenk und Aufbaurosette

Lamp type

5x G125 E27 max. 8W **A** - **E** 230V  
or 5x ST64 E27 max. 40W **A** - **E** 230V

Dimensions

L600xB600xH250 - Bar 600

Materials

INOX 32X | 46X | 53X | 31MX

Ref

5107.5.B3.31MX white texture  
5107.5.B3.32X black texture  
5107.5.B3.46X grey-brown  
5107.5.B3.53X bronze-brown

built-up

5108.9.B3/.. - TAVOLO SQ 800X800 - B3

~230V IP20 0,6 m 22,2500 0,5 m 05.20.02 CE

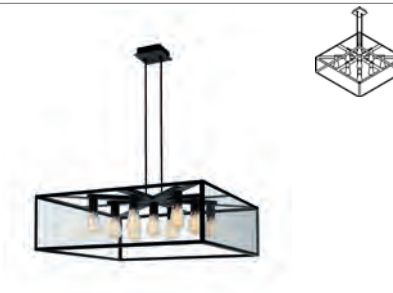

pendant with swivel and built-up base  
Pendelleuchte mit Kugelgelenk und Aufbaurosette

Lamp type

9x G125 E27 max. 8W **A** - **E** 230V  
or 9x ST64 E27 max. 40W **A** - **E** 230V

Dimensions

L800xB800xH250 - Bar 600

Materials

INOX 32X | 46X | 53X | 31MX

Ref

5108.9.B3.31MX white texture  
5108.9.B3.32X black texture  
5108.9.B3.46X grey-brown  
5108.9.B3.53X bronze-brown

built-up

SET TIGE/.. - TAVOLO SET TIGE

IP20 CE



supplement - set of 2 bars  
Supplement - Duo von Stangen

Materials

INOX 32X | 46X | 53X | 31MX

Colour	SETL1000/..	SETL1100/..	SETL1200/..	SETL400/..	SETL500/..	SETL600/..	SETL700/..	SETL800/..	SETL900/..
	L 1000	L 1100	L 1200	L 400	L 500	L 600	L 700	L 800	L 900
31MX									
32X									
46X									
53X									

Series Tavolo & Polina: use safety cotter pin supplied with suspension when installing  
Serie Tavolo & Polina : bitte verwenden Sie die mitgelieferte Sicherheitsspannhülsen bei der Installation





1820/.. - GOTA

~230V IP20 1,5 m 5,8800 0,5 m 05.20.50



pendant - with suspension + base - with electronic gear  
 Pendelleuchte - mit Aufhängung + Rosette - mit  
 elektronischem Vorschaltgerät

Ref  
 1820.14 alu satin

**Lamp type**  
 ↳ 2x T16FH T5 G5 max. 21W - 230V

**Dimensions**  
 ↳ Ø300xH1220

**Materials**  
 aluminium 14

built-up

1825/.. - GOTA

~230V IP20 1,5 m 5,6800 0,5 m 05.20.50



pendant - down - with suspension + base - with electronic gear  
 Pendelleuchte - down - mit Aufhängung + Rosette - mit  
 elektronischem Vorschaltgerät

Ref  
 1825.14 alu satin

**Lamp type**  
 ↳ 1x TC-DEL G24Q-2 max. 18W 230V  
 ↳ 2x T16FH T5 G5 max. 21W - 230V

**Dimensions**  
 ↳ Ø300xH1150 40° reflector

**Materials**  
 aluminium 14

built-up  
 other °angle reflector on demand  
 andere °Winkel Reflektor auf Anfrage

# INDOOR LUMINAIRES

## Index

**B**

BETAPLUS	457-459
BRIDGE	441

**C**

CALYPSO	435
CAMELEON-	362
CAMERA TWIN	442-443
CANVAS	413
CAPUCINE	398-400
CAPUCINE XL	401-403
CLARA	377-378
CUBIC	427-428
CUPIDO	424-426

**E**

EQUAL	358-361
-------	---------

**F**

FARFALLE	375
FIXER	475-480
FLOU	368-456

**J**

JACOB	367
JACOBINE	404-405

**K**

KOX	368
-----	-----

**L**

LOBBY	437
LOBBY	438
LUXOR UP	482-486

**M**

MAESTRO	371-374
MAMBO	441
MANTA UP	444-446
MERO	363-366
MONA LISA	387
MONET	448-454

**N**

NOTRE DAME	389
------------	-----

**O**

OLIVIA	382-386
OLIVIA MINI	379-381
OPERA	436

**P**

PLAZA	435
POLINA	369
POLO	487-489
PULA	472-474

**R**

RETRO	439
RICHARD	411-412
RINGO	390-393

**S**

SHAKE GLASS	370
SPINNER X	460-468
STELLA	413-423

**T**

THINDR	406-410
TITUS	432-434
TOLEDO	449-453
TORPEDO	481
TUBO	376
TWIPE	388

**V**

VICTOR	394-397
VOLTA	469
VOLTA + JUBA	469-470

**W**

WING LED	490
----------	-----

**Z**

ZOOM CLICK + VOLTA	428-431
--------------------	---------

2071/.. - EQUAL

~230V  IP20   0.5 m  05.20.02 



built-up ceiling light - round - fixed - down  
Aufbau Deckenleuchte - rund - fest - down

**Lamp type**

 1x QPAR 51 GU10 max. 20W  230V

**Dimensions**

 Ø80xH130  
Tube - Ø80xH120

**Materials**

aluminium 1M | 29 | 2M | 47 | 49 | 77

**Ref**

2071.1M	white tex
2071.2M	black tex
2071.29	black - gold inside
2071.47	black - white inside
2071.77	white - black inside
2071.49	white - gold inside

**built-up**

standard with YOKO-cassette - other cassettes on request  
Standard mit YOKO-Kassette - andere Kassetten auf Anfrage

2072/.. - EQUAL

~230V  IP20   0.5 m  05.20.02 



built-up ceiling light - round - fixed - down  
Aufbau Deckenleuchte - rund - fest - down

**Lamp type**

 2x QPAR 51 GU10 max. 20W  230V

**Dimensions**

 L170xB80xH130  
Tube - Ø80xH120

**Materials**

aluminium 1M | 29 | 2M | 47 | 49 | 77

**Ref**

2072.1M	white tex
2072.2M	black tex
2072.29	black - gold inside
2072.47	black - white inside
2072.77	white - black inside
2072.49	white - gold inside

**built-up**

standard with YOKO-cassette - other cassettes on request  
Standard mit YOKO-Kassette - andere Kassetten auf Anfrage

2073/.. - EQUAL

~230V  IP20   0.5 m  05.20.02 



built-up ceiling light - round - fixed - down  
Aufbau Deckenleuchte - rund - fest - down

**Lamp type**

 3x QPAR 51 GU10 max. 20W  230V

**Dimensions**

 L260xB80xH130  
Tube - Ø80xH120

**Materials**

aluminium 1M | 29 | 2M | 47 | 49 | 77

**Ref**

2073.1M	white tex
2073.2M	black tex
2073.29	black - gold inside
2073.47	black - white inside
2073.77	white - black inside
2073.49	white - gold inside

**built-up**

standard with YOKO-cassette - other cassettes on request  
Standard mit YOKO-Kassette - andere Kassetten auf Anfrage

2073T/.. - EQUAL

~230V  IP20   0.5 m  05.20.02 



built-up ceiling light - round - fixed - down  
Aufbau Deckenleuchte - rund - fest - down

**Lamp type**

 3x QPAR 51 GU10 max. 20W  230V

**Dimensions**

 L170xB170xH130  
Tube - Ø80xH120

**Materials**

aluminium 1M | 29 | 2M | 47 | 49 | 77

**Ref**

2073T.1M	white tex
2073T.2M	black tex
2073T.29	black - gold inside
2073T.47	black - white inside
2073T.77	white - black inside
2073T.49	white - gold inside

**built-up**

standard with YOKO-cassette - other cassettes on request  
Standard mit YOKO-Kassette - andere Kassetten auf Anfrage



2074SQ/.. - EQUAL

~230V  IP20    0.5 m  05.20.02 



built-up ceiling light - round - fixed - down  
 Aufbau Deckenleuchte - rund - fest - down

**Lamp type**

4x QPAR 51 GU10 max. 20W  -  230V

**Dimensions**

L170xB170xH130  
 Tube - Ø80xH120

**Materials**

aluminium 1M | 29 | 2M | 47 | 49 | 77

**Ref**

2074SQ.1M	white tex
2074SQ.2M	black tex
2074SQ.29	black - gold inside
2074SQ.47	black - white inside
2074SQ.77	white - black inside
2074SQ.49	white - gold inside

*built-up  
 standard with YOKO-cassette - other cassettes on  
 request  
 Standard mit YOKO-Kassette - andere Kassetten auf  
 Anfrage*



2081/.. - EQUAL



built-up ceiling light - round - fixed - down  
 Aufbau Deckenleuchte - rund - fest - down

Lamp type

1x LED AC 700lm CRI92 max. 9,5W **A+** 230V

Dimensions

Ø80xH150  $\wedge$  36° reflector  
 Tube - Ø80xH140

~230V



IP20



Ref

2081.1M	NW   WW
2081.2M	NW   WW
2081.29	NW   WW
2081.47	NW   WW
2081.77	NW   WW

built-up

standard with YOKO-cassette - other cassettes on request

Standard mit YOKO-Kassette - andere Kassetten auf Anfrage

2082/.. - EQUAL



built-up ceiling light - round - fixed - down  
 Aufbau Deckenleuchte - rund - fest - down

Lamp type

2x LED AC 700lm CRI92 max. 9,5W **A+** 230V

Dimensions

L170xB80xH150  $\wedge$  36° reflector  
 Tube - Ø80xH140

~230V



IP20



Ref

2082.1M	NW   WW
2082.2M	NW   WW
2082.29	NW   WW
2082.47	NW   WW
2082.77	NW   WW

built-up

standard with YOKO-cassette - other cassettes on request

Standard mit YOKO-Kassette - andere Kassetten auf Anfrage

2083/.. - EQUAL



built-up ceiling light - round - fixed - down  
 Aufbau Deckenleuchte - rund - fest - down

Lamp type

3x LED AC 700lm CRI92 max. 9,5W **A+** 230V

Dimensions

L260xB80xH150  $\wedge$  36° reflector  
 Tube - Ø80xH140

~230V



IP20



Ref

2083.1M	NW   WW
2083.2M	NW   WW
2083.29	NW   WW
2083.47	NW   WW
2083.77	NW   WW

built-up

standard with YOKO-cassette - other cassettes on request

Standard mit YOKO-Kassette - andere Kassetten auf Anfrage

2083T/.. - EQUAL



built-up ceiling light - round - fixed - down  
 Aufbau Deckenleuchte - rund - fest - down

Lamp type

3x LED AC 700lm CRI92 max. 9,5W **A+** 230V

Dimensions

L170xB170xH150  $\wedge$  36° reflector  
 Tube - Ø80xH140

~230V



IP20



Ref

2083T.1M	NW   WW
2083T.2M	NW   WW
2083T.29	NW   WW
2083T.47	NW   WW
2083T.77	NW   WW

built-up

standard with YOKO-cassette - other cassettes on request

Standard mit YOKO-Kassette - andere Kassetten auf Anfrage

2084SQ../.. - EQUAL

~230V



IP20



built-up ceiling light - round - fixed - down  
 Aufbau Deckenleuchte - rund - fest - down

Lamp type

4x LED AC 700lm CRI92 max. 9,5W **A+** 230V

Dimensions

L170xB170xH150 / 36° reflector  
 Tube - Ø80xH140

Ref

2084SQ.1M	NW   WW
2084SQ.2M	NW   WW
2084SQ.29	NW   WW
2084SQ.47	NW   WW
2084SQ.77	NW   WW

**built-up**  
 standard with YOKO-cassette - other cassettes on request  
 Standard mit YOKO-Kassette - andere Kassetten auf Anfrage



1511.ZXO/.. - CAMELEON DIM LED

~230V  IP20   0,5000 0,5 m 05.20.50 





built-up ceiling light - round - directional - down  
 Aufbau Deckenleuchte - rund - schwenkbar - down

Lamp type

 1x LED 850lm CRI90 max. 10W 230V

Dimensions

 Ø90xH120  60° reflector

Ref

1511.ZXO.1M	NW   WW
1511.ZXO.2M	NW   WW
1511.ZXO.14	NW   WW
1511.ZXO.29	NW   WW
1511.ZXO.45	NW   WW
1511.ZXO.55	NW   WW
1511.ZXO.59	NW   WW

built-up

WW 2700K 12,5W - NW 3000K 11,7W - 1000lm

1510.ZXO/.. - CAMELEON DIM LED

~230V  IP20   0,4300 0,5 m 05.20.50 





built-up ceiling light - round - fixed - down  
 Aufbau Deckenleuchte - rund - fest - down

Lamp type

 1x LED 850lm CRI90 max. 10W 230V

Dimensions

 Ø90xH120  90° reflector

Ref

1510.ZXO.1M	NW   WW
1510.ZXO.2M	NW   WW
1510.ZXO.14	NW   WW
1510.ZXO.29	NW   WW
1510.ZXO.45	NW   WW
1510.ZXO.52	NW   WW

built-up

WW 2700K 12,5W - NW 3000K 11,7W - 1000lm





1837.ES50/.. - MERO ES50

~230V



built-up ceiling light - fixed - down  
 Aufbau Deckenleuchte - fest - down

Lamp type

1x QPAR 51 GU10 max. 20W **A+** - **E** 230V

Dimensions

Ø70xH130

Materials

aluminium 14 | 1M | 29 | 2M | 45 | 49

Ref

1837.ES50.1M	white tex
1837.ES50.2M	black tex
1837.ES50.14	alu satin
1837.ES50.29	black - gold inside
1837.ES50.45	sun gold
1837.ES50.49	white - gold inside

built-up

1837.SLA/.. - MERO SLA

~230V



built-up ceiling light - fixed - down  
 Aufbau Deckenleuchte - fest - down

Lamp type

1x LED AC 700lm CRI92 max. 9,5W **A+** 230V

Dimensions

Ø70xH130

Ref

1837.SLA.1M	NW   WW
1837.SLA.2M	NW   WW
1837.SLA.14	NW   WW
1837.SLA.29	NW   WW
1837.SLA.45	NW   WW
1837.SLA.49	NW   WW

built-up





1834.250/.. - MERO

~230V  IP20   0.5 m  05.20.02 



built-up ceiling light - round - fixed - down  
Aufbau Deckenleuchte - rund - fest - down

**Lamp type**

 1x QPAR 51 GU10 max. 20W  -  **230V**

**Dimensions**

 Ø60xH250

**Materials**

aluminium 1M | 29 | 2M | 49

**Ref**

1834.250.1M	white tex
1834.250.2M	black tex
1834.250.29	black - gold inside
1834.250.49	white - gold inside

built-up



1834.300/.. - MERO

~230V  IP20   0.5 m  05.20.02 



built-up ceiling light - round - fixed - down  
Aufbau Deckenleuchte - rund - fest - down

**Lamp type**

 1x QPAR 51 GU10 max. 20W  -  **230V**

**Dimensions**

 Ø60xH300

**Materials**

aluminium 1M | 29 | 2M | 49

**Ref**

1834.300.1M	white tex
1834.300.2M	black tex
1834.300.29	black - gold inside
1834.300.49	white - gold inside

built-up

1834.400/.. - MERO

~230V  IP20   0.5 m  05.20.02 



built-up ceiling light - round - fixed - down  
Aufbau Deckenleuchte - rund - fest - down

**Lamp type**

 1x QPAR 51 GU10 max. 20W  -  **230V**

**Dimensions**

 Ø60xH400

**Materials**

aluminium 1M | 29 | 2M | 49

**Ref**

1834.400.1M	white tex
1834.400.2M	black tex
1834.400.29	black - gold inside
1834.400.49	white - gold inside

built-up

1834.675/.. - MERO

~230V  IP20   0.5 m  05.20.02 



built-up ceiling light - round - fixed - down  
Aufbau Deckenleuchte - rund - fest - down

**Lamp type**

 1x QPAR 51 GU10 max. 20W  -  **230V**

**Dimensions**

 Ø60xH400

**Materials**

aluminium 1M | 29 | 2M | 49

**Ref**

1834.675.1M	white tex
1834.675.2M	black tex
1834.675.29	black - gold inside
1834.675.49	white - gold inside

built-up



1834.900/.. - MERO

~230V  IP20     



built-up ceiling light - round - fixed - down  
 Aufbau Deckenleuchte - rund - fest - down

**Lamp type**

 1x QPAR 51 GU10 max. 20W  -  230V

**Dimensions**

 Ø60xH900

**Materials**

aluminium 1M | 29 | 2M | 49

**Ref**

1834.900.1M	white tex
1834.900.2M	black tex
1834.900.29	black - gold inside
1834.900.49	white - gold inside

built-up



1837C/.. - MERO 230V

~230V  IP20   0.3950 0.5 m 05.20.50 



built-up ceiling light - fixed - down  
Aufbau Deckenleuchte - fest - down

Lamp type

 1x LED 850lm CRI90 max. 10W 230V

Dimensions

↔ Ø70xH130  
Base - Ø60xH25

Ref

1837C.1M	NW   WW
1837C.2M	NW   WW
1837C.14	NW   WW
1837C.29	NW   WW
1837C.45	NW   WW
1837C.49	NW   WW

built-up

1839/.. - MERO XICATO

~230V  IP20   0.5 m 05.20.50 



built-up ceiling light - fixed - down - with XICATO LED module  
- with LED driver  
Aufbau Deckenleuchte - fest - down - mit LED-Modul XICATO  
- mit Driver LED

Lamp type

 1x Led 2000lm CRI80 max. 15,2W  -  700mA

Dimensions

↔ Ø120xH350

Ref







1839.1M	NW   WW
1839.2M	NW   WW
1839.14	NW   WW

built-up





3983.200/.. - JACOB

~230V   IP20    



built-up ceiling light - round - fixed - down - with LED driver  
 Aufbau Deckenleuchte - rund - fest - down - mit Driver LED





**Lamptype**  
 1x led 467lm CRI80 max. 3,8W  -  350mA

**Dimensions**  
 Ø40xH200  48° reflector

Ref	
3983.200.1M	NW   WW
3983.200.2M	NW   WW
3983.200.16	NW   WW
3983.200.29	NW   WW
3983.200.45	NW   WW



built-up

3983.300/.. - JACOB

~230V   IP20    



built-up ceiling light - round - fixed - down - with LED driver  
 Aufbau Deckenleuchte - rund - fest - down - mit Driver LED

**Lamptype**  
 1x led 467lm CRI80 max. 3,8W  -  350mA

**Dimensions**  
 Ø40xH300  48° reflector

Ref	
3983.300.1M	NW   WW
3983.300.2M	NW   WW
3983.300.16	NW   WW
3983.300.29	NW   WW
3983.300.45	NW   WW



built-up

3983.400/.. - JACOB

~230V   IP20    



built-up ceiling light - round - fixed - down - with LED driver  
 Aufbau Deckenleuchte - rund - fest - down - mit Driver LED

**Lamptype**  
 1x led 467lm CRI80 max. 3,8W  -  350mA

**Dimensions**  
 Ø40xH400  48° reflector

Ref	
3983.400.1M	NW   WW
3983.400.2M	NW   WW
3983.400.16	NW   WW
3983.400.29	NW   WW
3983.400.45	NW   WW

built-up

5228/.. - FLOU

~230V



IP20



built-up ceiling light - round - fixed - with led  
 Aufbau Deckenleuchte - rund - fest - mit Led

Lamp type

1x LED 850lm CRI90 max. 10W 230V

Dimensions

Ø90xD130 30° reflector

Ref

5228.1M	NW   WW
5228.2M.1M	NW   WW
5228.2M	NW   WW
5228.2M.45	NW   WW
5228.14	NW   WW
5228.45.45	NW   WW
5228.53.53	WW

built-up

WW 2700K 12,5W - NW 3000K 11,7W - 1000lm

1758/.. - KOX

~230V



IP20



built-up ceiling light - round - fixed - down  
 Aufbau Deckenleuchte - rund - fest - down

Lamp type

1x QPAR 51 GU10 max. 20W A+ - E 230V

Dimensions

Ø100xH110

Materials

aluminium 14 | 1M | 2M | 11M

Ref

1758.1M	white tex
1758.2M	black tex
1758.11M	grey tex
1758.14	alu satin

built-up

no room for transformer  
 Aria 230V

1759/.. - KOX

~230V



IP20



built-up ceiling light - round - directional - down  
 Aufbau Deckenleuchte - rund - schwenkbar - down

Lamp type

1x QPAR 51 GU10 max. 20W A+ - E 230V

Dimensions

Ø100xH110

Materials

aluminium 14 | 1M | 2M | 11M

Ref

1759.1M	white tex
1759.2M	black tex
1759.11M	grey tex
1759.14	alu satin

built-up

no room for transformer  
 Cambio 230V

5074/.. - POLINA

~230V



built-up ceiling light - round - fixed - glass H250  
 Aufbau Deckenleuchte - rund - fest - Glas H250

Lamp type

1x A60 E27 max. 60W A - E 230V  
 or 1x ST64 E27 max. 60W A - E 230V

Dimensions

Ø132xH285  
 Ø100xH27

Materials

INOX 32X | 46X | 64X | 31MX | 33MX

Ref

5074.31MX	white texture
5074.32X	black texture
5074.33MX	brown texture
5074.46X	grey-brown
5074.64X	black grey

built-up

5075/.. - POLINA

~230V



built-up ceiling light - round - fixed - glass H320  
 Aufbau Deckenleuchte - rund - fest - Glas H320

Lamp type

1x A60 E27 max. 60W A - E 230V  
 or 1x ST64 E27 max. 60W A - E 230V

Dimensions

Ø132xH355  
 Ø100xH27

Materials

INOX 32X | 46X | 53X | 64X | 31MX | 33MX

Ref

5075.31MX	white texture
5075.32X	black texture
5075.33MX	brown texture
5075.46X	grey-brown
5075.53X	bronze-brown
5075.64X	black grey

built-up

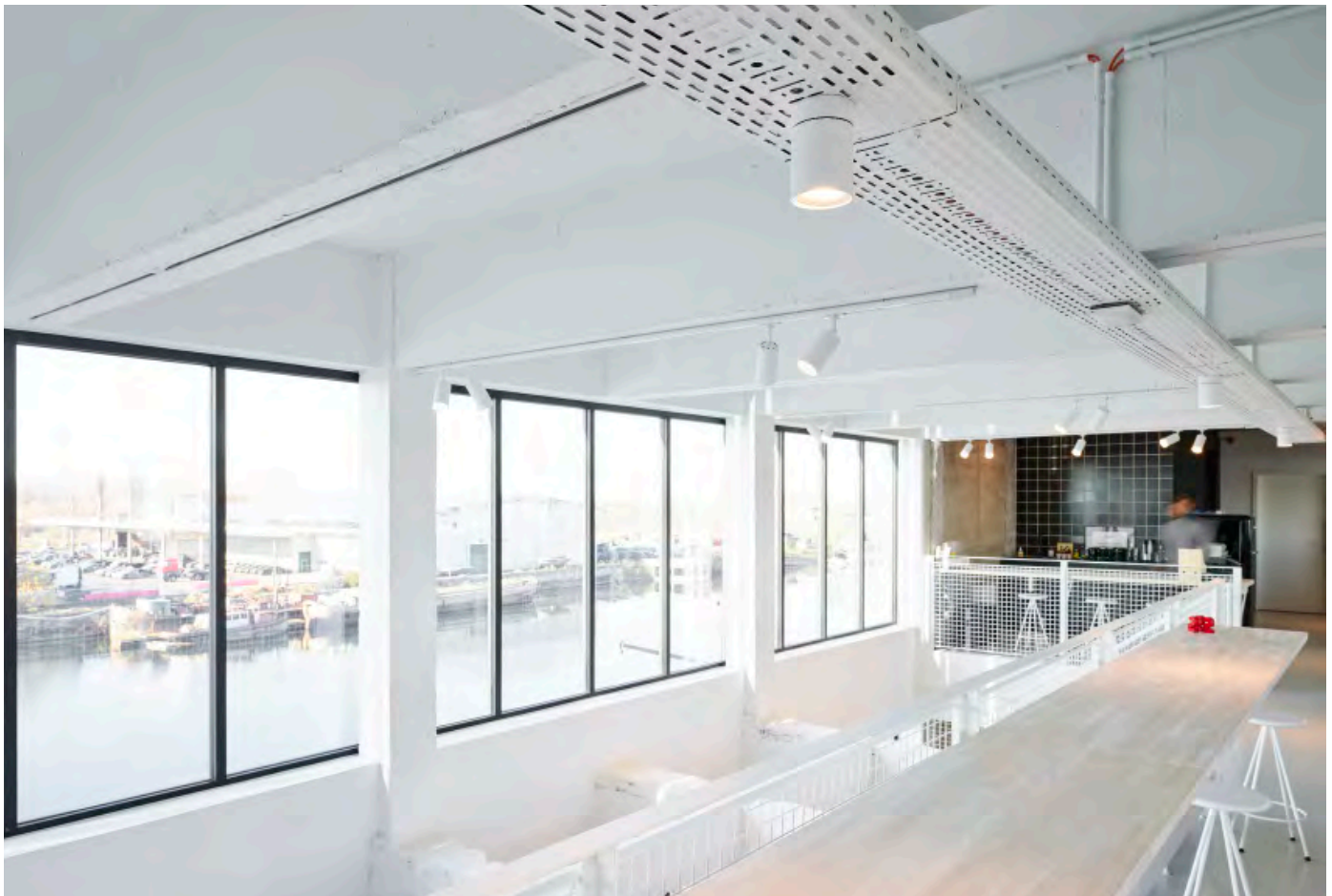

5558.E27/.. - SHAKE GLASS

~230V  IP20       



built-up ceiling light - fixed - down - with glass  
Aufbau Deckenleuchte - fest - down - mit Glas

**Lamp type**

1x A60 E27 max. 12W  230V

**Dimensions**

Ø160xH150

Ø105xH30

**Materials**

glass ST | TR

**Ref**

5558.E27.TR.1M.TX1	transparent
5558.E27.TR.2M.TX2	transparent
5558.E27.TR.14.TX11	transparent
5558.E27.TR.16.TXM	transparent
5558.E27.TR.28.TXRK	transparent
5558.E27.ST.1M.TX1	silver transparent
5558.E27.ST.2M.TX2	silver transparent
5558.E27.ST.14.TX11	silver transparent
5558.E27.ST.16.TXM	silver transparent
5558.E27.ST.28.TXRK	silver transparent

built-up

5559.E27/.. - SHAKE GLASS

~230V  IP20       



built-up ceiling light - fixed - down - with glass  
Aufbau Deckenleuchte - fest - down - mit Glas

**Lamp type**

1x A60 E27 max. 12W  230V

**Dimensions**

Ø180xH230

Ø105xH30

**Materials**

glass ST | TR

**Ref**

5559.E27.TR.1M.TX1	transparent
5559.E27.TR.2M.TX2	transparent
5559.E27.TR.14.TX11	transparent
5559.E27.TR.16.TXM	transparent
5559.E27.TR.28.TXRK	transparent
5559.E27.ST.1M.TX1	silver transparent
5559.E27.ST.2M.TX2	silver transparent
5559.E27.ST.14.TX11	silver transparent
5559.E27.ST.16.TXM	silver transparent
5559.E27.ST.28.TXRK	silver transparent

built-up







5037/.. - MAESTRO

~230V  IP20     0,2300  0,5 m  05.20.02 



built-up ceiling or wall light - directional - with E27 lampholder  
Decken- oder Wandleuchte für Aufbau - schwenkbar - mit E27 Fassung

**Lamp type**  
 1x A60 E27 max. 10,5W  230V  
 or  1x ST64 E27 max. 7,7w  230V

**Dimensions**  
 Ø60xH132  
 Base - Ø60xH25  
 Housing - Ø46xH62  
 Bar - H45

**Materials**  
 aluminium 14 | 1M | 2M | 46  
 brass 13 | 16

Ref	
5037.1M	white tex
5037.2M	black tex
5037.13	bronze
5037.14	alu satin
5037.16	satin gold
5037.46	grey-brown

built-up

5038/.. - MAESTRO

~230V  IP20    0,2400  0,5 m  05.20.02 



built-up ceiling light - fixed - with E27 lampholder  
Aufbau Deckenleuchte - fest - mit E27 Fassung

**Lamp type**  
 1x A60 E27 max. 10,5W  230V

**Dimensions**  
 Ø80xH87  
 Base - Ø80xH25  
 Housing - Ø45xH62

**Materials**  
 aluminium 14 | 1M | 2M | 46

Ref	
5038.1M	white tex
5038.2M	black tex
5038.14	alu satin
5038.46	grey-brown

built-up

5038B/.. - MAESTRO

~230V  IP20    0,2900  0,5 m  05.20.02 



built-up ceiling light - fixed - with E27 lampholder  
Aufbau Deckenleuchte - fest - mit E27 Fassung

**Lamp type**  
 1x A60 E27 max. 10,5W  230V

**Dimensions**  
 Ø80xH87  
 Ø60xH25  
 Coverplate - Ø80xH2  
 Housing - Ø40xH60

**Materials**  
 aluminium 14 | 1M | 2M | 46

Ref	
5038B.1M	white tex
5038B.2M	black tex
5038B.14	alu satin
5038B.46	grey-brown

built-up

5058B/.. - MAESTRO

~230V



IP20



0,7200

0,5 m

05.20.02



built-up ceiling light - directional - with E27 lampholder on kneejoint  
 Aufbau Deckenleuchte - schwenkbar - mit E27 Fassung mit Kniegelenk

Lamp type

2x ST64 E27 max. 40W A - E 230V

Dimensions

Ø60xL540xH175

Base - Ø80xH25

Materials

aluminium 1M | 2M | 46

Ref

5058B.1M

white tex

5058B.2M

black tex

5058B.46

grey-brown

built-up

5050.5/.. - MAESTRO

~230V



IP20



2,0000

0,5 m

05.20.02

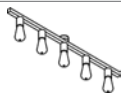

built-up ceiling light - fixed - with 5 lampholders E27  
 Aufbau Deckenleuchte - fest - mit 5 E27-Fassungen

Lamp type

5x A60 E27 max. 30W A - E 230V

or 5x ST64 E27 max. 40W A - E 230V

Dimensions

Ø60xL1000xH130

Base - Ø60xH40

Materials

aluminium 1M | 2M | 46 | RAL 9001

Ref

5050.5.1M

white tex

5050.5.2M

black tex

5050.5.46

grey-brown

5050.5.RAL 9001[MT]

Cream

built-up

5058/.. - MAESTRO

~230V



IP20



0,5 m

05.20.02

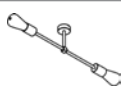

built-up ceiling light - fixed - with E27 lampholder  
 Aufbau Deckenleuchte - fest - mit E27 Fassung

Lamp type

2x ST64 E27 max. 40W A - E 230V

Dimensions

Ø60xL400xH115 - Bar 100

Base - Ø60xH40

Materials

aluminium 1M | 2M | 46

Ref

5058.1M

white tex

5058.2M

black tex

5058.46

grey-brown

built-up

5008/.. - MAESTRO

~230V

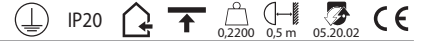

ceiling light for lampshade - fixed - with E27 lampholder  
Deckenleuchte für Lampenschirm - fest - mit E27 Fassung

Lamp type

1x A60 E27 max. 60W A - E 230V

Dimensions

Ø80xH87

Materials

aluminium 14 | 1M | 2M | 46

Ref

5008.1M	white tex
5008.2M	black tex
5008.14	alu satin
5008.46	grey-brown

*built-up  
lampshade not included  
Lampenschirm nicht einbegriffen*

5009/.. - MAESTRO

~230V



ceiling light for lampshade - with E27 lampholder on  
kneejoint  
Deckenleuchte für Lampenschirm - mit E27 Fassung mit  
Kniegelenk

Lamp type

3x A60 E27 max. 60W A - E 230V

Dimensions

Ø80xL180xH87

Materials

aluminium 2 | 14 | 1M | 2M | 46

Ref

5009.1M	white tex
5009.2	black
5009.2M	black tex
5009.14	alu satin
5009.46	grey-brown

*built-up  
lampshade not included  
Lampenschirm nicht einbegriffen*

5001/.. - MAESTRO

~230V



ceiling light for lampshade - with E27 lampholder  
Deckenleuchte für Lampenschirm - mit E27 Fassung

Lamp type

1x A60 E27 max. 60W A - E 230V

Dimensions

Ø60xH90  
Coverplate - Ø80

Materials

aluminium 14 | 1M | 2M | 46

Ref

5001.1M	white tex
5001.2M	black tex
5001.14	alu satin
5001.46	grey-brown

built-up  
lampshade not included  
Lampenschirm nicht einbegriffen

5001.10/.. - MAESTRO

~230V



ceiling light for lampshade - with E27 lampholder  
Deckenleuchte für Lampenschirm - mit E27 Fassung

Lamp type

1x A60 E27 max. 60W A - E 230V

Dimensions

Ø60xH190 - Bar 100  
Coverplate - Ø80  
Bar - L100

Materials

aluminium 14 | 1M | 2M | 46

Ref

5001.10.1M	white tex
5001.10.2M	black tex
5001.10.14	alu satin
5001.10.46	grey-brown

built-up  
lampshade not included  
Lampenschirm nicht einbegriffen

5006/.. - MAESTRO

~230V



ceiling light for lampshade - with E27 lampholder  
Deckenleuchte für Lampenschirm - mit E27 Fassung

Lamp type

1x A60 E27 max. 60W A - E 230V

Dimensions

L60xB60xH90  
Coverplate - L85xB85

Materials

aluminium 14 | 1M | 2M | 46

Ref

5006.1M	white tex
5006.2M	black tex
5006.14	alu satin
5006.46	grey-brown

built-up  
lampshade not included  
Lampenschirm nicht einbegriffen

5006.10/.. - MAESTRO

~230V



ceiling light for lampshade - with E27 lampholder  
Deckenleuchte für Lampenschirm - mit E27 Fassung

Lamp type

1x A60 E27 max. 60W A - E 230V

Dimensions

L60xB60xH190 - Bar 100  
Coverplate - L85xB85  
Bar - L100

Materials

aluminium 14 | 1M | 2M | 46

Ref

5006.10.1M	white tex
5006.10.2M	black tex
5006.10.14	alu satin
5006.10.46	grey-brown

built-up  
lampshade not included  
Lampenschirm nicht einbegriffen



1368/.. - FARFALLE

~230V



built-up ceiling light - fixed  
Aufbau Deckenleuchte - fest

Lamp type

1x A60 E27 max. 10,5W A - E 230V

Dimensions

Ø320xH70

Materials

aluminium 1M | 2M | 45 | 78 | 79 | 81 | 93

Ref

1368.1M	white tex
1368.2M	black tex
1368.45	sun gold
1368.93	bronze-brown
1368.78	pastel blue
1368.79	pastel pink
1368.81	pastel green

built-up

1369/.. - FARFALLE

~230V



built-up ceiling light - fixed  
Aufbau Deckenleuchte - fest

Lamp type

1x A60 E27 max. 10,5W A - E 230V

Dimensions

Ø390xH70

Materials

aluminium 1M | 2M | 45 | 78 | 79 | 81 | 93

Ref

1369.1M	white tex
1369.2M	black tex
1369.45	sun gold
1369.93	bronze-brown
1369.78	pastel blue
1369.79	pastel pink
1369.81	pastel green

built-up



5200.E27/.. - TUBO

~230V



built-up ceiling light - fixed - down  
Aufbau Deckenleuchte - fest - down

Lamp type

1x G125 E27 max. 6W **A+** - **E** 230V

Dimensions

Ø85xH93

Housing - Ø55

Materials

INOX 304 1M | 2M | 45 | 11M

Ref

5200.E27.1M	white tex
5200.E27.2M	black tex
5200.E27.11M	grey tex
5200.E27.45	sun gold

built-up

5200.ES50/.. - TUBO

~230V



built-up ceiling light - fixed - down  
Aufbau Deckenleuchte - fest - down

Lamp type

1x QPAR 51 GU10 max. 20W **A+** - **E** 230V

Dimensions

Ø85xH93

Housing - Ø55

Materials

INOX 304 1M | 2M | 45 | 11M

Ref

5200.ES50.1M	white tex
5200.ES50.2M	black tex
5200.ES50.11M	grey tex
5200.ES50.45	sun gold

built-up



3403/.. - CLARA

~230V



built-up ceiling light - fixed - down  
Aufbau Deckenleuchte - fest - down

Lamp type

1x QPAR 51 GU10 max. 20W **A+** - **E** 230V

Dimensions

Ø80xH137

Materials

aluminium 14 | 1M | 29 | 2M  
red copper 28

Ref

3403.1M white tex  
3403.2M black tex  
3403.14 alu satin  
3403.28 rosé  
3403.29 black - gold inside

built-up

3402.ES50/.. - CLARA

~230V



built-up ceiling light - fixed - down  
Aufbau Deckenleuchte - fest - down

Lamp type

1x QPAR70 GU10 max. 7W **A+** 230V

Dimensions

Ø122xH165

Materials

aluminium 14 | 1M | 29 | 2M | 47  
red copper 28

Ref

3402.ES50.1M white tex  
3402.ES50.2M black tex  
3402.ES50.14 alu satin  
3402.ES50.28 rosé  
3402.ES50.29 black - gold inside  
3402.ES50.47 black - white inside

built-up

3402/.. - CLARA

~230V

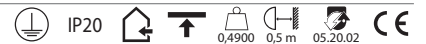

built-up ceiling light - fixed - down  
Aufbau Deckenleuchte - fest - down

Lamp type

1x A60 E27 max. 40W **A+** - **E** 230V

Dimensions

Ø122xH165

Materials

aluminium 14 | 1M | 29 | 2M | 47  
red copper 28

Ref

3402.1M white tex  
3402.2M black tex  
3402.14 alu satin  
3402.28 rosé  
3402.29 black - gold inside  
3402.47 black - white inside

built-up

3400.IP20/.. - CLARA XICATO

~230V



built-up ceiling light - fixed - down - with LED driver  
 Aufbau Deckenleuchte - fest - down - mit Driver LED

Lamp type

1x Led 965lm CRI80 max. 6,6W A - A+ 500mA

Dimensions

Ø122xH165 40° reflector  
 Reflector - Ø111

Ref

3400.IP20.1M	NW   WW
3400.IP20.2M	NW   WW
3400.IP20.14	NW   WW
3400.IP20.28	NW   WW

built-up

3401.IP20/.. - CLARA XICATO

=500mA



built-up ceiling light - fixed - down - without LED driver  
 Aufbau Deckenleuchte - fest - down - ohne Driver LED

Lamp type

1x Led 965lm CRI80 max. 6,6W A - A+ 500mA

Dimensions

Ø122xH165 40° reflector  
 Reflector - Ø111

Ref

3401.IP20.1M	NW   WW
3401.IP20.2M	NW   WW
3401.IP20.14	NW   WW
3401.IP20.28	NW   WW

built-up



1911.ES50/.. - OLIVIA MINI

~230V



built-up ceiling light - fixed - down  
Aufbau Deckenleuchte - fest - down

Lamp type

1x QPAR 51 GU10 max. 20W **A** - **E** 230V

Dimensions

Ø100xH140

Ø60

Materials

aluminium 14 | 1M | 2M  
brass 13 | 23

Ref

1911.ES50.1M white tex  
1911.ES50.2M black tex  
1911.ES50.13 bronze  
1911.ES50.14 alu satin  
1911.ES50.23 dark bronze

built-up

1911.E27/.. - OLIVIA MINI

~230V

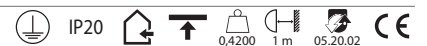

built-up ceiling light - fixed - down  
Aufbau Deckenleuchte - fest - down

Lamp type

1x TC-SEI E27 max. 11W **A** - **B** 230V

Dimensions

Ø100xH140

Ø60

Materials

aluminium 14 | 1M | 2M  
brass 13 | 23

Ref

1911.E27.1M white tex  
1911.E27.2M black tex  
1911.E27.13 bronze  
1911.E27.14 alu satin  
1911.E27.23 dark bronze

built-up

1912.ES50/.. - OLIVIA MINI

~230V



built-up ceiling light - fixed - down  
Aufbau Deckenleuchte - fest - down

Lamp type

2x QPAR 51 GU10 max. 20W **A** - **E** 230V

Dimensions

L400xB100xH140

L360xB60

Materials

aluminium 14 | 1M | 2M  
brass 13 | 23

Ref

1912.ES50.1M white tex  
1912.ES50.2M black tex  
1912.ES50.13 bronze  
1912.ES50.14 alu satin  
1912.ES50.23 dark bronze

built-up

1912.E27/.. - OLIVIA MINI

~230V



built-up ceiling light - fixed - down  
Aufbau Deckenleuchte - fest - down

Lamp type

2x TC-SEI E27 max. 11W **A** - **B** 230V

Dimensions

L400xB100xH140

L360xB60

Materials

aluminium 14 | 1M | 2M  
brass 13 | 23

Ref

1912.E27.1M white tex  
1912.E27.2M black tex  
1912.E27.13 bronze  
1912.E27.14 alu satin  
1912.E27.23 dark bronze

built-up



1913.ES50/.. - OLIVIA MINI

~230V

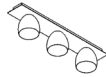

built-up ceiling light - fixed - down  
Aufbau Deckenleuchte - fest - down

Lamp type

3x QPAR 51 GU10 max. 20W **A+** - **E** 230V

Dimensions

L600xB100xH140  
L560xB60

Materials

aluminium 14 | 1M | 2M  
brass 13 | 23

Ref

1913.ES50.1M white tex  
1913.ES50.2M black tex  
1913.ES50.13 bronze  
1913.ES50.14 alu satin  
1913.ES50.23 dark bronze

built-up

1913.E27/.. - OLIVIA MINI

~230V

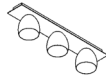

built-up ceiling light - fixed - down  
Aufbau Deckenleuchte - fest - down

Lamp type

3x TC-SEI E27 max. 11W **A** - **B** 230V

Dimensions

L600xB100xH140  
L560xB60

Materials

aluminium 14 | 1M | 2M  
brass 13 | 23

Ref

1913.E27.1M white tex  
1913.E27.2M black tex  
1913.E27.13 bronze  
1913.E27.14 alu satin  
1913.E27.23 dark bronze

built-up

1914.ES50/.. - OLIVIA MINI

~230V

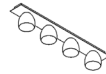

built-up ceiling light - fixed - down  
Aufbau Deckenleuchte - fest - down

Lamp type

4x QPAR 51 GU10 max. 20W **A+** - **E** 230V

Dimensions

L800xB100xH140  
L760xB60

Materials

aluminium 14 | 1M | 2M  
brass 13 | 23

Ref

1914.ES50.1M white tex  
1914.ES50.2M black tex  
1914.ES50.13 bronze  
1914.ES50.14 alu satin  
1914.ES50.23 dark bronze

built-up

1914.E27/.. - OLIVIA MINI

~230V

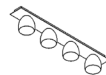

built-up ceiling light - fixed - down  
Aufbau Deckenleuchte - fest - down

Lamp type

4x TC-SEI E27 max. 11W **A** - **B** 230V

Dimensions

L800xB100xH140  
L760xB60

Materials

aluminium 14 | 1M | 2M  
brass 13 | 23

Ref

1914.E27.1M white tex  
1914.E27.2M black tex  
1914.E27.13 bronze  
1914.E27.14 alu satin  
1914.E27.23 dark bronze

built-up

1915.ES50/.. - OLIVIA MINI

~230V

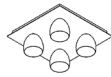

built-up ceiling light - fixed - down  
Aufbau Deckenleuchte - fest - down

Lamp type

4x QPAR 51 GU10 max. 20W A - E 230V

Dimensions

L400xB400xH140

L360xB360

Materials

aluminium 14 | 1M | 2M

brass 13 | 23

Ref

1915.ES50.1M	white tex
1915.ES50.2M	black tex
1915.ES50.13	bronze
1915.ES50.14	alu satin
1915.ES50.23	dark bronze

built-up

1915.E27/.. - OLIVIA MINI

~230V

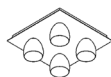

built-up ceiling light - fixed - down  
Aufbau Deckenleuchte - fest - down

Lamp type

4x TC-SEI E27 max. 11W A - B 230V

Dimensions

L400xB400xH140

L360xB360

Materials

aluminium 14 | 1M | 2M

brass 13 | 23

Ref

1915.E27.1M	white tex
1915.E27.2M	black tex
1915.E27.13	bronze
1915.E27.14	alu satin
1915.E27.23	dark bronze

built-up



1811.E27/.. - OLIVIA

~230V



built-up ceiling light - fixed - down - with E27 lampholder  
 Aufbau Deckenleuchte - fest - down - mit E27 Fassung

Lamp type

1x A60 E27 max. 40W A - E 230V

Dimensions

Ø162xH154

Ø140

Materials

aluminium 1M | 29 | 2M | 47 | 11M

Ref

1811.E27.1M	white tex
1811.E27.2M.7	black tex
1811.E27.2M.52	black tex
1811.E27.11M	grey tex
1811.E27.11M.14	grey tex
1811.E27.29	black - gold inside
1811.E27.47	black - white inside

built-up

1812.E27/.. - OLIVIA

~230V



built-up ceiling light - fixed - down - with E27 lampholder  
 Aufbau Deckenleuchte - fest - down - mit E27 Fassung

Lamp type

2x A60 E27 max. 40W A - E 230V

Dimensions

L365xB162xH154

L280xB80

Materials

aluminium 1M | 29 | 2M | 47 | 11M

Ref

1812.E27.1M	white tex
1812.E27.2M.7	black tex
1812.E27.2M.52	black tex
1812.E27.11M	grey tex
1812.E27.11M.14	grey tex
1812.E27.29	black - gold inside
1812.E27.47	black - white inside

built-up

1813.E27/.. - OLIVIA

~230V

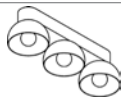
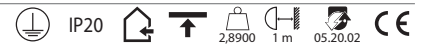

built-up ceiling light - fixed - down - with E27 lampholder  
 Aufbau Deckenleuchte - fest - down - mit E27 Fassung

Lamp type

3x A60 E27 max. 40W A - E 230V

Dimensions

L560xB162xH154

L475xB80

Materials

aluminium 1M | 29 | 2M | 47 | 11M

Ref

1813.E27.1M	white tex
1813.E27.2M.7	black tex
1813.E27.2M.52	black tex
1813.E27.11M	grey tex
1813.E27.11M.14	grey tex
1813.E27.29	black - gold inside
1813.E27.47	black - white inside

built-up

1814.E27/.. - OLIVIA

~230V



built-up ceiling light - down - with E27 lampholder  
 Aufbau Deckenleuchte - down - mit E27 Fassung

Lamp type

4x A60 E27 max. 40W A - E 230V

Dimensions

L760xB162xH154

L670xB80

Materials

aluminium 1M | 29 | 2M | 47 | 11M

Ref

1814.E27.1M	white tex
1814.E27.2M.7	black tex
1814.E27.2M.52	black tex
1814.E27.11M	grey tex
1814.E27.11M.14	grey tex
1814.E27.29	black - gold inside
1814.E27.47	black - white inside

built-up

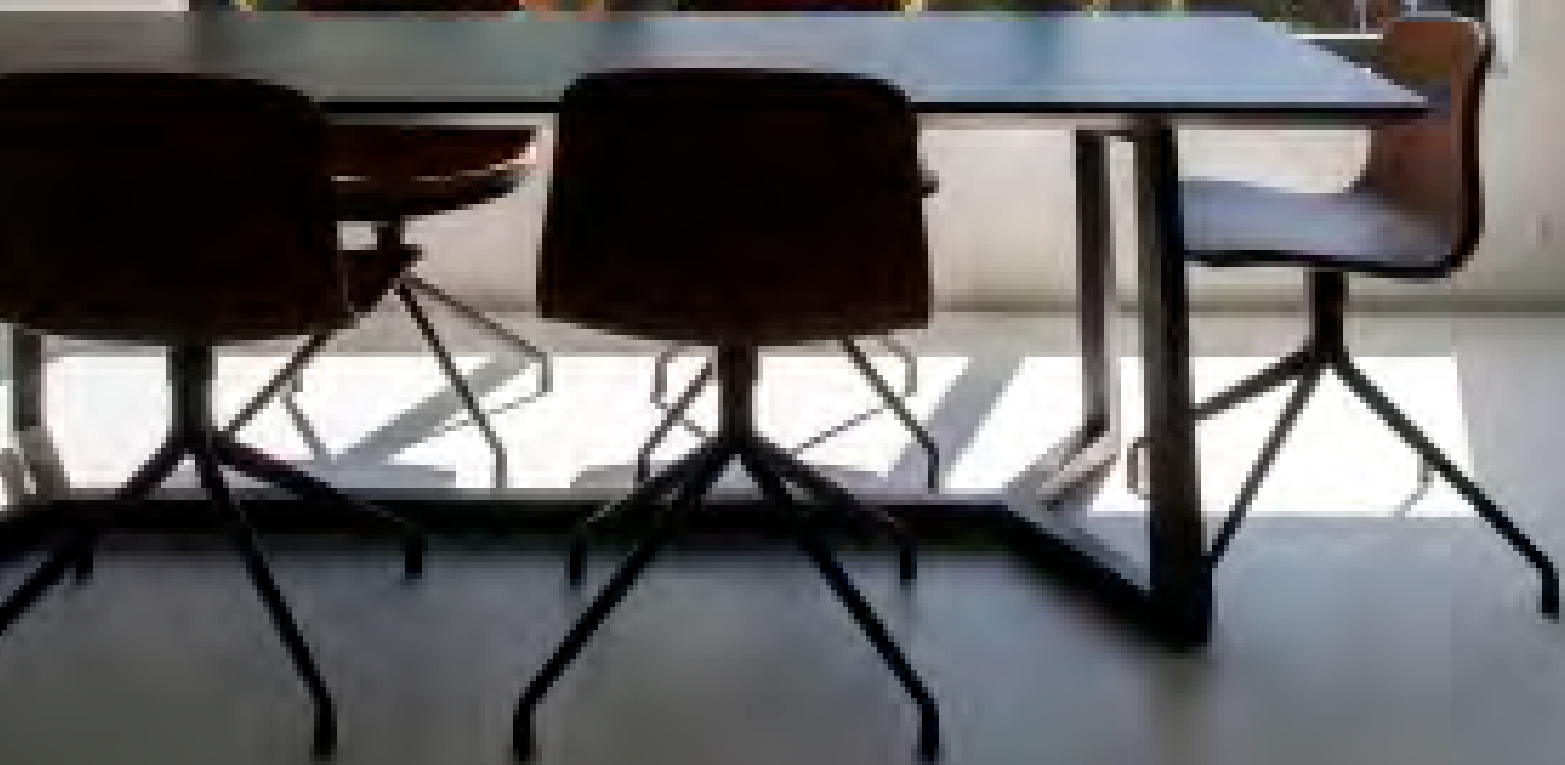

1815.E27/.. - OLIVIA

~230V



built-up ceiling light - fixed - down - with E27 lampholder  
 Aufbau Deckenleuchte - fest - down - mit E27 Fassung

**Lamp type**

3x A60 E27 max. 40W A - E 230V

**Dimensions**

L370xB370xH154

L275xB275

**Materials**

aluminium 1M | 29 | 2M | 47 | 11M

**Ref**

1815.E27.1M	white tex
1815.E27.2M.7	black tex
1815.E27.2M.52	black tex
1815.E27.11M	grey tex
1815.E27.11M.14	grey tex
1815.E27.29	black - gold inside
1815.E27.47	black - white inside

built-up

1816.E27/.. - OLIVIA

~230V



built-up ceiling light - fixed - down - with E27 lampholder  
 Aufbau Deckenleuchte - fest - down - mit E27 Fassung

**Lamp type**

4x A60 E27 max. 40W A - E 230V

**Dimensions**

L365xB365xH154

L280xB280

**Materials**

aluminium 1M | 29 | 2M | 47 | 11M

**Ref**

1816.E27.1M	white tex
1816.E27.2M.7	black tex
1816.E27.2M.52	black tex
1816.E27.11M	grey tex
1816.E27.11M.14	grey tex
1816.E27.29	black - gold inside
1816.E27.47	black - white inside

built-up





1811/.. - OLIVIA

~230V    IP20    1,6500  1 m  05.20.50 





built-up ceiling light - fixed - with transformer - with LED driver  
 Aufbau Deckenleuchte - fest - mit Trafo - mit Driver LED

Lamp type

-  1x QR-LP111 G53 max. 50W A - C 12V
-  1x powered 350mA max. 1W A - A+ 350mA

Dimensions

-  Ø162xH154
-  Ø140

Ref

1811.1M	B   CW   WW
1811.2M.B	B   CW   WW
1811.11M.B	B   CW   WW
1811.14.B	B   CW   WW
1811.2M.7.B	B   CW   WW

built-up  
 only dimmable on 2 circuits  
 nur dimmbar bei 2 Stromkreise

1812/.. - OLIVIA

~230V    IP20    2,2550  1 m  05.20.50 





built-up ceiling light - fixed - with transformer - with LED driver  
 Aufbau Deckenleuchte - fest - mit Trafo - mit Driver LED

Lamp type

-  2x QR-LP111 G53 max. 35W A - C 12V
-  2x powered 350mA max. 1W A - A+ 350mA

Dimensions

-  L365xB162xH154
-  L280xB80

Ref

1812.1M.B	B   CW   WW
1812.2M.B	B   CW   WW
1812.11M.B	B   CW   WW
1812.2M.7.B	B   CW   WW
1812.11M.14	B   CW   WW

built-up  
 only dimmable on 2 circuits  
 nur dimmbar bei 2 Stromkreise

1813/.. - OLIVIA

~230V    IP20    5,6800  1 m  05.20.50 





built-up ceiling light - fixed - with transformer - with LED driver  
 Aufbau Deckenleuchte - fest - mit Trafo - mit Driver LED

Lamp type

-  3x QR-LP111 G53 max. 35W A - C 12V
-  3x powered 350mA max. 1W A - A+ 350mA

Dimensions

-  L560xB162xH154
-  L475xB80

Ref

1813.1M.B	B   CW   WW
1813.2M.B	B   CW   WW
1813.11M.B	B   CW   WW
1813.2M.7.B	B   CW   WW
1813.11M.14	B   CW   WW

built-up  
 only dimmable on 2 circuits  
 nur dimmbar bei 2 Stromkreise

1814/.. - OLIVIA

~230V    IP20    5,6800  1 m  05.20.50 





built-up ceiling light - fixed - with transformer - with LED driver  
 Aufbau Deckenleuchte - fest - mit Trafo - mit Driver LED

Lamp type

-  4x QR-LP111 G53 max. 35W A - C 12V
-  4x powered 350mA max. 1W A - A+ 350mA

Dimensions

-  L760xB162xH154
-  L670xB80

Ref

1814.1M.B	B   CW   WW
1814.2M.B	B   CW   WW
1814.11M.B	B   CW   WW
1814.2M.7.B	B   CW   WW
1814.11M.14	B   CW   WW

built-up  
 only dimmable on 2 circuits  
 nur dimmbar bei 2 Stromkreise

1815/.. - OLIVIA



~230V   IP20   4,0550  1 m  



built-up ceiling light - fixed - with transformer - with LED driver  
 Aufbau Deckenleuchte - fest - mit Trafo - mit Driver LED

Lamp type

 3x QR-LP111 G53 max. 35W  12V

 3x powered 350mA max. 1W  350mA

Dimensions

 L370xB370xH154

 L275xB275

Ref

1815.1M.B	B   CW   WW
1815.2M.B	B   CW   WW
1815.11M.B	B   CW   WW
1815.2M.7.B	B   CW   WW
1815.11M.14	B   CW   WW

built-up  
 only dimmable on 2 circuits  
 nur dimmbar bei 2 Stromkreise

1816/.. - OLIVIA



~230V   IP20   5,3400  1 m  



built-up ceiling light - fixed - with transformer - with LED driver  
 Aufbau Deckenleuchte - fest - mit Trafo - mit Driver LED

Lamp type

 4x QR-LP111 G53 max. 35W  12V

 4x powered 350mA max. 1W  350mA

Dimensions

 L365xB365xH154

 L280xB280

Ref

1816.1M.B	B   CW   WW
1816.2M.B	B   CW   WW
1816.11M.B	B   CW   WW
1816.2M.7.B	B   CW   WW
1816.11M.14	B   CW   WW

built-up  
 only dimmable on 2 circuits  
 nur dimmbar bei 2 Stromkreise



Dome in glass covered with gold leaf on the inside

Glaskuppel mit Blattgold innen

**4066/.. - MONA LISA Ø300 - B3**

~230V

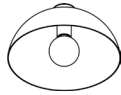

built-up ceiling light - black mat outside - papyrus leaf gold inside - with mounting on the ceiling  
 Aufbau Deckenleuchte - matt Schwarz an der Aussenseite - Papyrus Blattgold an der Innenseite - Befestigung an der Decke

Ref

4066.2M

black tex



**Lamptype**

1x G80 E27 max. 6W ▶ ▶ 230V

**Dimensions**

Ø300xH150

**Materials**

aluminium 2M

built-up  
 mounting on the ceiling  
 Befestigung an der Decke

**4063/.. - MONA LISA Ø450**

~230V



built-up ceiling light - black mat outside - papyrus leaf gold inside - with mounting on the ceiling  
 Aufbau Deckenleuchte - matt Schwarz an der Aussenseite - Papyrus Blattgold an der Innenseite - Befestigung an der Decke

Ref

4063.2M

black tex



**Lamptype**

1x G95 E27 max. 6W ▶ ▶ 230V

**Dimensions**

Ø450xH150

**Materials**

aluminium 2M

built-up  
 mounting on the ceiling  
 Befestigung an der Decke

**4059/.. - MONA LISA Ø550**

~230V



built-up ceiling light - black mat outside - papyrus leaf gold inside - with mounting on the ceiling  
 Aufbau Deckenleuchte - matt Schwarz an der Aussenseite - Papyrus Blattgold an der Innenseite - Befestigung an der Decke

Ref

4059.2M

black tex



**Lamptype**

1x G125 E27 max. 6W ▶ ▶ 230V

**Dimensions**

Ø550xH200

**Materials**

aluminium 2M

built-up  
 mounting on the ceiling  
 Befestigung an der Decke

1801LED/.. - TWIPE LED

~230V



built-up ceiling light - fixed - down - with LED driver  
 Aufbau Deckenleuchte - fest - down - mit Driver LED

Lamp type

1x Led 1300lm CRI80 max. 9,5W A - A+ 700mA

Dimensions

Ø200xH400 40° reflector  
 Ø90

Ref

1801LED.1M	NW
1801LED.2M	NW
1801LED.11M	NW

built-up  
 other °angle reflector on demand - phase-cut  
 andere °Winkel Reflektor auf Anfrage -  
 Phasenabschnitt  
 wall light on request  
 Wandleuchte auf Anfrage

1802.LED/.. - TWIPE LED

~230V



built-up ceiling light - fixed - down - with LED driver  
 Aufbau Deckenleuchte - fest - down - mit Driver LED

Lamp type

2x Led 1300lm CRI80 max. 9,5W A - A+ 700mA

Dimensions

L405xB400 40° reflector  
 L265xB60

Materials

aluminium 1M | 2M | 11M

Ref

1802.LED.1M.NW	white tex
1802.LED.2M.NW	black tex
1802.LED.11M.NW	grey tex

built-up  
 other °angle reflector on demand - phase-cut  
 andere °Winkel Reflektor auf Anfrage -  
 Phasenabschnitt  
 wall light on request  
 Wandleuchte auf Anfrage





2487/.. - NOTRE DAME

~230V



built-up ceiling light - with electronic gear  
Aufbau Deckenleuchte - mit elektronischem Vorschaltgerät

Lamp type

○ 1x TL16-R 2GX13 max. 55W **A<sup>+</sup>** - **B** 230V

Dimensions

↔ Ø510xH310

↖ Ø75

Materials

aluminium 14 | 1M | 2M | 46

Ref

2487.1M	white tex
2487.2M	black tex
2487.14	alu satin
2487.46	grey-brown

built-up

2487.LED/.. - NOTRE DAME LED

~230V

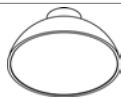

built-up ceiling light - with LED driver  
Aufbau Deckenleuchte - mit Driver LED

Lamp type

⚡ 1x Led 1800lm max. 13W **A<sup>+</sup>** 700mA

Dimensions

↔ Ø510xH310

↖ Ø75

Materials

aluminium 14 | 1M | 2M | 46

Ref

2487.LED.1M.NW	white tex
2487.LED.2M.NW	black tex
2487.LED.14.NW	alu satin
2487.LED.46.NW	grey-brown

built-up

2488/.. - NOTRE DAME

~230V



built-up ceiling light - with transformer - with electronic gear  
Aufbau Deckenleuchte - mit Trafo - mit elektronischem Vorschaltgerät

Lamp type

○ 1x TL16-R 2GX13 max. 55W **A<sup>+</sup>** - **B** 230V

⚡ 1x QR-LP111 G53 max. 50W **A** - **C** 12V

Dimensions

↔ Ø510xH310

↖ Ø75

Materials

aluminium 14 | 1M | 2M

Ref

2488.1M	white tex
2488.2M	black tex
2488.14	alu satin

built-up

2488.LED/.. - NOTRE DAME LED

~230V

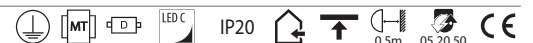

built-up ceiling light - with transformer - with LED driver  
Aufbau Deckenleuchte - mit Trafo - mit Driver LED

Lamp type

⚡ 1x Led 1800lm max. 13W **A<sup>+</sup>** 700mA

⚡ 1x QR-LP111 G53 max. 50W **A** - **C** 12V

Dimensions

↔ Ø510xH310

↖ Ø75

Materials

aluminium 14 | 1M | 2M

Ref

2488.LED.1M.NW	white tex
2488.LED.2M.NW	black tex
2488.LED.14.NW	alu satin

built-up



3230/.. - RINGO

~230V IP20 0,5 m 05.20.02 CE



built-up ceiling light - directional - with base 025  
Aufbau Deckenleuchte - schwenkbar - mit Basis 025

Lamp type

1x QPAR 51 GU10 max. 20W A+ - E 230V

Dimensions

L60xB60xH90

L60xB60xH25

Materials

aluminium 14 | 1M | 2M

Ref

3230.1M white tex  
3230.2M black tex  
3230.14 alu satin

built-up

3231/.. - RINGO

~230V IP20 0,5 m 05.20.02 CE



built-up ceiling light - directional - with Texo base  
Aufbau Deckenleuchte - schwenkbar - mit Texo Basis

Lamp type

1x QPAR 51 GU10 max. 20W A+ - E 230V

Dimensions

L85xB85xH90

L60xB60

Materials

aluminium 14 | 1M | 2M

Ref

3231.1M white tex  
3231.2M black tex  
3231.14 alu satin

built-up

3232/.. - RINGO

~230V IP20 0,7000 0,5 m 05.20.02 CE



built-up ceiling light - directional - with Texo base  
Aufbau Deckenleuchte - schwenkbar - mit Texo Basis

Lamp type

2x QPAR 51 GU10 max. 20W A+ - E 230V

Dimensions

L200xB85xH90

L175xB60

Materials

aluminium 14 | 1M | 2M

Ref

3232.1M white tex  
3232.2M black tex  
3232.14 alu satin

built-up

3233/.. - RINGO

~230V IP20 0,5 m 05.20.02 CE



built-up ceiling light - directional - with Texo base  
Aufbau Deckenleuchte - schwenkbar - mit Texo Basis

Lamp type

3x QPAR 51 GU10 max. 20W A+ - E 230V

Dimensions

L300xB85xH90

L275xB60

Materials

aluminium 14 | 1M | 2M

Ref

3233.1M white tex  
3233.2M black tex  
3233.14 alu satin

built-up

3234/.. - RINGO

~230V



built-up ceiling light - directional - with Texo base  
 Aufbau Deckenleuchte - schwenkbar - mit Texo Basis

Lamp type

4x QPAR 51 GU10 max. 20W A+ - E 230V

Dimensions

L400xB85xH90

L375xB60

Materials

aluminium 14 | 1M | 2M

Ref

3234.1M	white tex
3234.2M	black tex
3234.14	alu satin

built-up

3235/.. - RINGO

~230V



built-up ceiling light - square - directional - with Texo base  
 Aufbau Deckenleuchte - viereckig - schwenkbar - mit Texo Basis

Lamp type

4x QPAR 51 GU10 max. 20W A+ - E 230V

Dimensions

L200xB200xH90

L185xB185

Materials

aluminium 14 | 1M | 2M

Ref

3235.1M	white tex
3235.2M	black tex
3235.14	alu satin

built-up



3240/.. - RINGO

~230V



built-up ceiling light - directional - with base 005  
Aufbau Deckenleuchte - schwenkbar - mit Basis 005

Lamp type

1x QPAR 51 GU10 max. 20W A+ - E 230V

Dimensions

Ø60xH90

Materials

aluminium 14 | 1M | 2M

Ref

3240.1M	white tex
3240.2M	black tex
3240.14	alu satin

built-up

3241/.. - RINGO

~230V



built-up ceiling light - directional - with base 020  
Aufbau Deckenleuchte - schwenkbar - mit Basis 020

Lamp type

1x QPAR 51 GU10 max. 20W A+ - E 230V

Dimensions

Ø60xH105

Materials

aluminium 14 | 1M | 2M

Ref

3241.1M	white tex
3241.2M	black tex
3241.14	alu satin

built-up

3242/.. - RINGO

~230V



built-up ceiling light - directional - with Rondobox base  
Aufbau Deckenleuchte - schwenkbar - mit Basis Rondobox

Lamp type

1x QPAR 51 GU10 max. 20W A+ - E 230V

Dimensions

Ø100xH90

Ø80

Materials

aluminium 14 | 1M | 2M

Ref

3242.1M	white tex
3242.2M	black tex
3242.14	alu satin

built-up

3243/.. - RINGO

~230V



built-up ceiling light - directional - with Rondobox base  
Aufbau Deckenleuchte - schwenkbar - mit Basis Rondobox

Lamp type

2x QPAR 51 GU10 max. 20W A+ - E 230V

Dimensions

Ø150xH90

Ø125

Materials

aluminium 14 | 1M | 2M

Ref

3243.1M	white tex
3243.2M	black tex
3243.14	alu satin

built-up

3244/.. - RINGO

~230V



built-up ceiling light - directional - with Rondobox base  
 Aufbau Deckenleuchte - schwenkbar - mit Basis Rondobox

Lamp type

3x QPAR 51 GU10 max. 20W A+ - E 230V

Dimensions

Ø200xH90

Ø175

Materials

aluminium 14 | 1M | 2M

Ref

3244.1M

3244.2M

3244.14

white tex

black tex

alu satin

built-up

3245/.. - RINGO

~230V



built-up ceiling light - directional - with Rondobox base  
 Aufbau Deckenleuchte - schwenkbar - mit Basis Rondobox

Lamp type

4x QPAR 51 GU10 max. 20W A+ - E 230V

Dimensions

Ø250xH90

Ø220

Materials

aluminium 14 | 1M | 2M

Ref

3245.1M

3245.2M

3245.14

white tex

black tex

alu satin

built-up

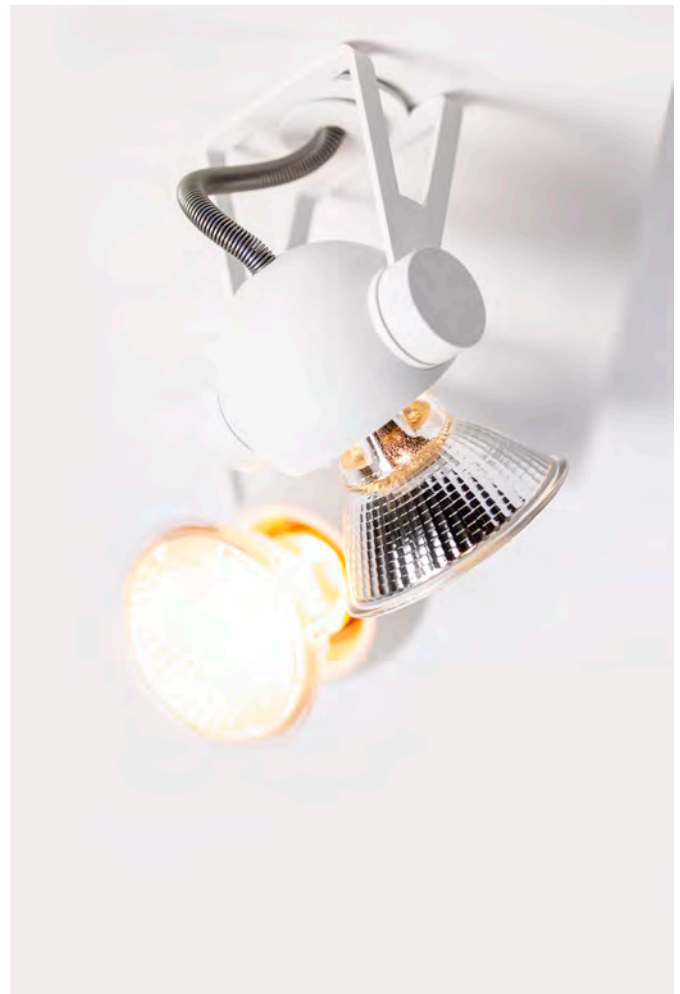

3210/.. - VICTOR

~230V



built-up ceiling light - directional - with base 025  
Aufbau Deckenleuchte - schwenkbar - mit Basis 025

Lamp type

1x QPAR 51 GU10 max. 20W A+ - E **230V**

Dimensions

L60xB60xH105

L60xB60

Materials

aluminium 14 | 1M | 2M | 46 | 33M

Ref

3210.1M	white tex
3210.2M	black tex
3210.14	alu satin
3210.33M	brown texture
3210.46	grey-brown

built-up

3211/.. - VICTOR

~230V



built-up ceiling light - directional - with Texo base  
Aufbau Deckenleuchte - schwenkbar - mit Texo Basis

Lamp type

1x QPAR 51 GU10 max. 20W A+ - E **230V**

Dimensions

L85xB85xH110

L60xB60

Materials

aluminium 14 | 1M | 2M | 46 | 33M

Ref

3211.1M	white tex
3211.2M	black tex
3211.14	alu satin
3211.33M	brown texture
3211.46	grey-brown

built-up

3212/.. - VICTOR

~230V



built-up ceiling light - directional - with Texo base  
Aufbau Deckenleuchte - schwenkbar - mit Texo Basis

Lamp type

2x QPAR 51 GU10 max. 20W A+ - E **230V**

Dimensions

L200xB85xH110

L175xB60

Materials

aluminium 14 | 1M | 2M | 46 | 33M

Ref

3212.1M	white tex
3212.2M	black tex
3212.14	alu satin
3212.33M	brown texture
3212.46	grey-brown

built-up

3213/.. - VICTOR

~230V



built-up ceiling light - directional - with Texo base  
Aufbau Deckenleuchte - schwenkbar - mit Texo Basis

Lamp type

3x QPAR 51 GU10 max. 20W A+ - E **230V**

Dimensions

L300xB85xH110

L275xB60

Materials

aluminium 14 | 1M | 2M | 46 | 33M

Ref

3213.1M	white tex
3213.2M	black tex
3213.14	alu satin
3213.33M	brown texture
3213.46	grey-brown

built-up



3214/.. - VICTOR

~230V



built-up ceiling light - directional - with Texo base  
 Aufbau Deckenleuchte - schwenkbar - mit Texo Basis

Lamp type

4x QPAR 51 GU10 max. 20W A+ - E 230V

Dimensions

L400xB85xH110

L375xB60

Materials

aluminium 14 | 1M | 2M | 46 | 33M

Ref

3214.1M	white tex
3214.2M	black tex
3214.14	alu satin
3214.33M	brown texture
3214.46	grey-brown

built-up

3203/.. - VICTOR

~230V



built-up ceiling light - directional - with Texo base  
 Aufbau Deckenleuchte - schwenkbar - mit Texo Basis

Lamp type

4x QPAR 51 GU10 max. 20W A+ - E 230V

Dimensions

L215xB215xH110

L185xB185

Materials

aluminium 14 | 1M | 2M | 46 | 33M

Ref

3203.1M	white tex
3203.2M	black tex
3203.14	alu satin
3203.33M	brown texture
3203.46	grey-brown

built-up



3220/.. - VICTOR

~230V



built-up ceiling light - directional - with base 005  
Aufbau Deckenleuchte - schwenkbar - mit Basis 005

Lamp type

1x QPAR 51 GU10 max. 20W **A+** - **E** 230V

Dimensions

Ø60xH100

Materials

aluminium 14 | 1M | 2M | 46 | 33M

Ref

3220.1M	white tex
3220.2M	black tex
3220.14	alu satin
3220.33M	brown texture
3220.46	grey-brown

built-up

3221/.. - VICTOR

~230V



built-up ceiling light - directional - with base 020  
Aufbau Deckenleuchte - schwenkbar - mit Basis 020

Lamp type

1x QPAR 51 GU10 max. 20W **A+** - **E** 230V

Dimensions

Ø60xH115

Materials

aluminium 14 | 1M | 2M | 46 | 33M

Ref

3221.1M	white tex
3221.2M	black tex
3221.14	alu satin
3221.33M	brown texture
3221.46	grey-brown

built-up

3222/.. - VICTOR

~230V



built-up ceiling light - directional - with Rondobox base  
Aufbau Deckenleuchte - schwenkbar - mit Basis Rondobox

Lamp type

1x QPAR 51 GU10 max. 20W **A+** - **E** 230V

Dimensions

Ø100xH100

Ø80

Materials

aluminium 14 | 1M | 2M | 46 | 33M

Ref

3222.1M	white tex
3222.2M	black tex
3222.14	alu satin
3222.33M	brown texture
3222.46	grey-brown

built-up

3223/.. - VICTOR

~230V

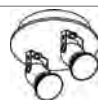

built-up ceiling light - directional - with Rondobox base  
Aufbau Deckenleuchte - schwenkbar - mit Basis Rondobox

Lamp type

2x QPAR 51 GU10 max. 20W **A+** - **E** 230V

Dimensions

Ø150xH100

Ø125

Materials

aluminium 14 | 1M | 2M | 46 | 33M

Ref

3223.1M	white tex
3223.2M	black tex
3223.14	alu satin
3223.33M	brown texture
3223.46	grey-brown

built-up

3224/.. - VICTOR

~230V



built-up ceiling light - directional - with Rondobox base  
 Aufbau Deckenleuchte - schwenkbar - mit Basis Rondobox

Lamp type

3x QPAR 51 GU10 max. 20W A+ - E 230V

Dimensions

Ø200xH100

Ø175

Materials

aluminium 14 | 1M | 2M | 46 | 33M

Ref

3224.1M	white tex
3224.2M	black tex
3224.14	alu satin
3224.33M	brown texture
3224.46	grey-brown

built-up

3225/.. - VICTOR

~230V



built-up ceiling light - directional - with Rondobox base  
 Aufbau Deckenleuchte - schwenkbar - mit Basis Rondobox

Lamp type

4x QPAR 51 GU10 max. 20W A+ - E 230V

Dimensions

Ø250xH100

Ø220

Materials

aluminium 14 | 1M | 2M | 46 | 33M

Ref

3225.1M	white tex
3225.2M	black tex
3225.14	alu satin
3225.33M	brown texture
3225.46	grey-brown

built-up



4500/.. - CAPUCINE

~230V



built-up ceiling light - directional - with base 005  
Aufbau Deckenleuchte - schwenkbar - mit Basis 005

Lamp type

1x QPAR 51 GU10 max. 20W A+ - E ▶ 230V  
or 1x QPAR70 GU10 max. 7W A+ 230V

Dimensions

Ø60xH120  
Ø60xH25

Materials

aluminium 1M | 2M | 46 | 33M

Ref

4500.1M	white tex
4500.2M	black tex
4500.33M	brown texture
4500.46	grey-brown

built-up

4501/.. - CAPUCINE

~230V



built-up ceiling light - directional - with Rondobox base  
Aufbau Deckenleuchte - schwenkbar - mit Basis Rondobox

Lamp type

1x QPAR 51 GU10 max. 20W A+ - E ▶ 230V  
or 1x QPAR70 GU10 max. 7W A+ 230V

Dimensions

Ø100xH120  
Ø80

Materials

aluminium 1M | 2M | 46 | 33M

Ref

4501.1M	white tex
4501.2M	black tex
4501.33M	brown texture
4501.46	grey-brown

built-up

4502/.. - CAPUCINE

~230V



built-up ceiling light - directional - with Rondobox base  
Aufbau Deckenleuchte - schwenkbar - mit Basis Rondobox

Lamp type

2x QPAR 51 GU10 max. 20W A+ - E ▶ 230V  
or 2x QPAR70 GU10 max. 7W A+ 230V

Dimensions

Ø150xH120  
Ø125

Materials

aluminium 1M | 2M | 46 | 33M

Ref

4502.1M	white tex
4502.2M	black tex
4502.33M	brown texture
4502.46	grey-brown

built-up

4503/.. - CAPUCINE

~230V

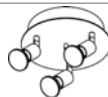

built-up ceiling light - directional - with Rondobox base  
Aufbau Deckenleuchte - schwenkbar - mit Basis Rondobox

Lamp type

3x QPAR 51 GU10 max. 20W A+ - E ▶ 230V  
or 3x QPAR70 GU10 max. 7W A+ 230V

Dimensions

Ø200xH120  
Ø175

Materials

aluminium 1M | 2M | 46 | 33M

Ref

4503.1M	white tex
4503.2M	black tex
4503.33M	brown texture
4503.46	grey-brown

built-up

4503X/.. - CAPUCINE

~230V



built-up ceiling light - directional - with Rondobox base  
Aufbau Deckenleuchte - schwenkbar - mit Basis Rondobox

Lamp type

3x QPAR 51 GU10 max. 20W A+ - E 230V  
or 3x QPAR70 GU10 max. 7W A+ 230V

Dimensions

Ø250xH120  
Ø220

Materials

aluminium 1M | 2M | 46 | 33M

Ref

4503X.1M	white tex
4503X.2M	black tex
4503X.33M	brown texture
4503X.46	grey-brown

built-up

4504/.. - CAPUCINE

~230V

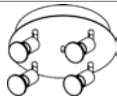

built-up ceiling light - directional - with Rondobox base  
Aufbau Deckenleuchte - schwenkbar - mit Basis Rondobox

Lamp type

4x QPAR 51 GU10 max. 20W A+ - E 230V  
or 4x QPAR70 GU10 max. 7W A+ 230V

Dimensions

Ø250xH120  
Ø220

Materials

aluminium 1M | 2M | 46 | 33M

Ref

4504.1M	white tex
4504.2M	black tex
4504.33M	brown texture
4504.46	grey-brown

built-up

4510/.. - CAPUCINE

~230V



built-up ceiling light - directional - with base 025  
Aufbau Deckenleuchte - schwenkbar - mit Basis 025

Lamp type

1x QPAR 51 GU10 max. 20W A+ - E 230V  
or 1x QPAR70 GU10 max. 7W A+ 230V

Dimensions

L60xB60xH120  
L60xB60

Materials

aluminium 1M | 2M | 46 | 33M

Ref

4510.1M	white tex
4510.2M	black tex
4510.33M	brown texture
4510.46	grey-brown

built-up

4511/.. - CAPUCINE

~230V



built-up ceiling light - directional - with Texo base  
Aufbau Deckenleuchte - schwenkbar - mit Texo Basis

Lamp type

1x QPAR 51 GU10 max. 20W A+ - E 230V  
1x QPAR70 GU10 max. 7W A+ 230V

Dimensions

L85xB85xH125  
L60xB60

Materials

aluminium 1M | 2M | 46 | 33M

Ref

4511.1M	white tex
4511.2M	black tex
4511.33M	brown texture
4511.46	grey-brown

built-up



4512/.. - CAPUCINE

~230V

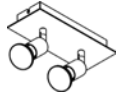

built-up ceiling light - directional - with Texo base  
 Aufbau Deckenleuchte - schwenkbar - mit Texo Basis

Lamp type

2x QPAR 51 GU10 max. 20W A+ - E 230V  
 or 2x QPAR70 GU10 max. 7W A+ 230V

Dimensions

L200xB85xH125  
 L175xB60

Materials

aluminium 1M | 2M | 46 | 33M

Ref

4512.1M	white tex
4512.2M	black tex
4512.33M	brown texture
4512.46	grey-brown

built-up

4513/.. - CAPUCINE

~230V

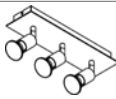

built-up ceiling light - directional - with Texo base  
 Aufbau Deckenleuchte - schwenkbar - mit Texo Basis

Lamp type

3x QPAR 51 GU10 max. 20W A+ - E 230V  
 or 3x QPAR70 GU10 max. 7W A+ 230V

Dimensions

L300xB85xH125  
 L275xB60

Materials

aluminium 1M | 2M | 46 | 33M

Ref

4513.1M	white tex
4513.2M	black tex
4513.33M	brown texture
4513.46	grey-brown

built-up

4514/.. - CAPUCINE

~230V

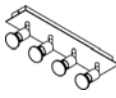

built-up ceiling light - directional - with Texo base  
 Aufbau Deckenleuchte - schwenkbar - mit Texo Basis

Lamp type

4x QPAR 51 GU10 max. 20W A+ - E 230V  
 or 4x QPAR70 GU10 max. 7W A+ 230V

Dimensions

L400xB85xH125  
 L375xB60

Materials

aluminium 1M | 2M | 46 | 33M

Ref

4514.1M	white tex
4514.2M	black tex
4514.33M	brown texture
4514.46	grey-brown

built-up

4515/.. - CAPUCINE

~230V

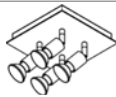

built-up ceiling light - directional - with Texo base  
 Aufbau Deckenleuchte - schwenkbar - mit Texo Basis

Lamp type

4x QPAR 51 GU10 max. 20W A+ - E 230V  
 or 4x QPAR70 GU10 max. 7W A+ 230V

Dimensions

L200xB200xH125  
 L185xB185

Materials

aluminium 1M | 2M | 46 | 33M

Ref

4515.1M	white tex
4515.2M	black tex
4515.33M	brown texture
4515.46	grey-brown



built-up



4530/.. - CAPUCINE XL

~230V        



built-up ceiling light - directional - with base 005  
Aufbau Deckenleuchte - schwenkbar - mit Basis 005

**Lamp type**  
 1x LED AC 700lm CRI92 max. 9,5W  230V

**Dimensions**  
 Ø60xH205  36° reflector  
 Ø60xH25  
 Spot - Ø55xH130

Ref	
4530.1M	NW   WW
4530.2M	NW   WW
4530.4	NW   WW
4530.14	NW   WW
4530.16	NW   WW
4530.45	NW   WW



built-up



4531/.. - CAPUCINE XL

~230V       



built-up ceiling light - directional - with Rondobox base  
Aufbau Deckenleuchte - schwenkbar - mit Basis Rondobox

**Lamp type**  
 1x LED AC 700lm CRI92 max. 9,5W  230V

**Dimensions**  
 Ø100xH205  36° reflector  
 Ø80xH25  
 Spot - Ø55xH130

Ref	
4531.1M	NW   WW
4531.2M	NW   WW
4531.4	NW   WW
4531.14	NW   WW
4531.16	NW   WW
4531.45	NW   WW

built-up



4532/.. - CAPUCINE XL

~230V       



built-up ceiling light - directional - with Rondobox base  
Aufbau Deckenleuchte - schwenkbar - mit Basis Rondobox

**Lamp type**  
 2x LED AC 700lm CRI92 max. 9,5W  230V

**Dimensions**  
 Ø150xH205  36° reflector  
 Ø125xH25  
 Spot - Ø55xH130

Ref	
4532.1M	NW   WW
4532.2M	NW   WW
4532.4	NW   WW
4532.14	NW   WW
4532.16	NW   WW
4532.45	NW   WW

built-up



4533/.. - CAPUCINE XL

~230V       



built-up ceiling light - directional - with Rondobox base  
Aufbau Deckenleuchte - schwenkbar - mit Basis Rondobox

**Lamp type**  
 3x LED AC 700lm CRI92 max. 9,5W  230V

**Dimensions**  
 Ø250xH206  36° reflector  
 Ø220  
 Spot - Ø55xH130

Ref	
4533.1M	NW   WW
4533.2M	NW   WW
4533.4	NW   WW
4533.14	NW   WW
4533.16	NW   WW
4533.45	NW   WW

built-up

4534/.. - CAPUCINE XL

~230V

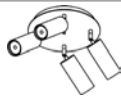

built-up ceiling light - directional - with Rondobox base  
Aufbau Deckenleuchte - schwenkbar - mit Basis Rondobox

Lamp type

4x LED AC 700lm CRI92 max. 9,5W **A+** 230V

Dimensions

Ø250xH206  $\wedge$  36° reflector

Ø220xH25

Spot - Ø55xH130

Ref

4534.1M	NW   WW
4534.2M	NW   WW
4534.4	NW   WW
4534.14	NW   WW
4534.16	NW   WW
4534.45	NW   WW



built-up

4535/.. - CAPUCINE XL

~230V

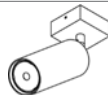

built-up ceiling light - directional - with base 025  
Aufbau Deckenleuchte - schwenkbar - mit Basis 025

Lamp type

1x LED AC 700lm CRI92 max. 9,5W **A+** 230V

Dimensions

L60xB60xH205  $\wedge$  36° reflector

L60xB60xH25

Spot - Ø55xH130

Ref

4535.1M	NW   WW
4535.2M	NW   WW
4535.4	NW   WW
4535.14	NW   WW
4535.16	NW   WW
4535.45	NW   WW



built-up

4536/.. - CAPUCINE XL

~230V

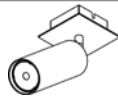

built-up ceiling light - directional - with Texo base  
Aufbau Deckenleuchte - schwenkbar - mit Texo Basis

Lamp type

1x LED AC 700lm CRI92 max. 9,5W **A+** 230V

Dimensions

L85xB85xH210  $\wedge$  36° reflector

L60xB60xH30

Spot - Ø55xH130

Ref

4536.1M	NW   WW
4536.2M	NW   WW
4536.4	NW   WW
4536.14	NW   WW
4536.16	NW   WW
4536.45	NW   WW



built-up

4537/.. - CAPUCINE XL

~230V



built-up ceiling light - directional - with Texo base  
Aufbau Deckenleuchte - schwenkbar - mit Texo Basis

Lamp type

2x LED AC 700lm CRI92 max. 9,5W **A+** 230V

Dimensions

L200xB85xH210  $\wedge$  36° reflector

L175xB60xH30

Spot - Ø55xH130

Ref

4537.1M	NW   WW
4537.2M	NW   WW
4537.4	NW   WW
4537.14	NW   WW
4537.16	NW   WW
4537.45	NW   WW



built-up

4538/.. - CAPUCINE XL

~230V



IP20



built-up ceiling light - directional - with Texo base  
Aufbau Deckenleuchte - schwenkbar - mit Texo Basis

Lamp type

3x LED AC 700lm CRI92 max. 9,5W **A+** 230V

Dimensions

L300xB85xH210  $\wedge$  36° reflector

L275xB60xH30

Spot - Ø55xH130

Ref

4538.1M	NW   WW
4538.2M	NW   WW
4538.4	NW   WW
4538.14	NW   WW
4538.16	NW   WW
4538.45	NW   WW

built-up

4539/.. - CAPUCINE XL

~230V



IP20

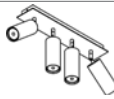

built-up ceiling light - directional - with Texo base  
Aufbau Deckenleuchte - schwenkbar - mit Texo Basis

Lamp type

4x LED AC 700lm CRI92 max. 9,5W **A+** 230V

Dimensions

L400xB85xH210  $\wedge$  36° reflector

L375xB60xH30

Spot - Ø55xH130

Ref

4539.1M	NW   WW
4539.2M	NW   WW
4539.4	NW   WW
4539.14	NW   WW
4539.16	NW   WW
4539.45	NW   WW

built-up

4540/.. - CAPUCINE XL

~230V



IP20

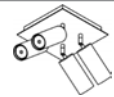

built-up ceiling light - directional - with Texo base  
Aufbau Deckenleuchte - schwenkbar - mit Texo Basis

Lamp type

4x LED AC 700lm CRI92 max. 9,5W **A+** 230V

Dimensions

L215xB215xH210  $\wedge$  36° reflector

L375xB60xH30

Spot - Ø55xH130

Ref

4540.1M	NW   WW
4540.2M	NW   WW
4540.4	NW   WW
4540.14	NW   WW
4540.16	NW   WW
4540.45	NW   WW

built-up

4520/.. - JACOBINE

=350mA



built-up ceiling light - directional - with base 025 - without LED driver  
 Aufbau Deckenleuchte - schwenkbar - mit Basis 025 - ohne Driver LED

Ref

4520.1M	NW   WW
4520.2M	NW   WW
4520.14	NW   WW

Lamp type

1x led 467lm CRI80 max. 3,8W A - A+ 350mA

Dimensions

L60xB60xH150  $\wedge$  48° reflector  
 L60xB60



built-up

4521/.. - JACOBINE

=350mA

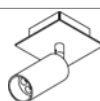

built-up ceiling light - directional - with Texo base - without LED driver  
 Aufbau Deckenleuchte - schwenkbar - mit Texo Basis - ohne Driver LED

Ref

4521.1M	NW   WW
4521.2M	NW   WW
4521.14	NW   WW

Lamp type

1x led 467lm CRI80 max. 3,8W A - A+ 350mA

Dimensions

L85xB85xH150  $\wedge$  48° reflector  
 L60xB60



built-up

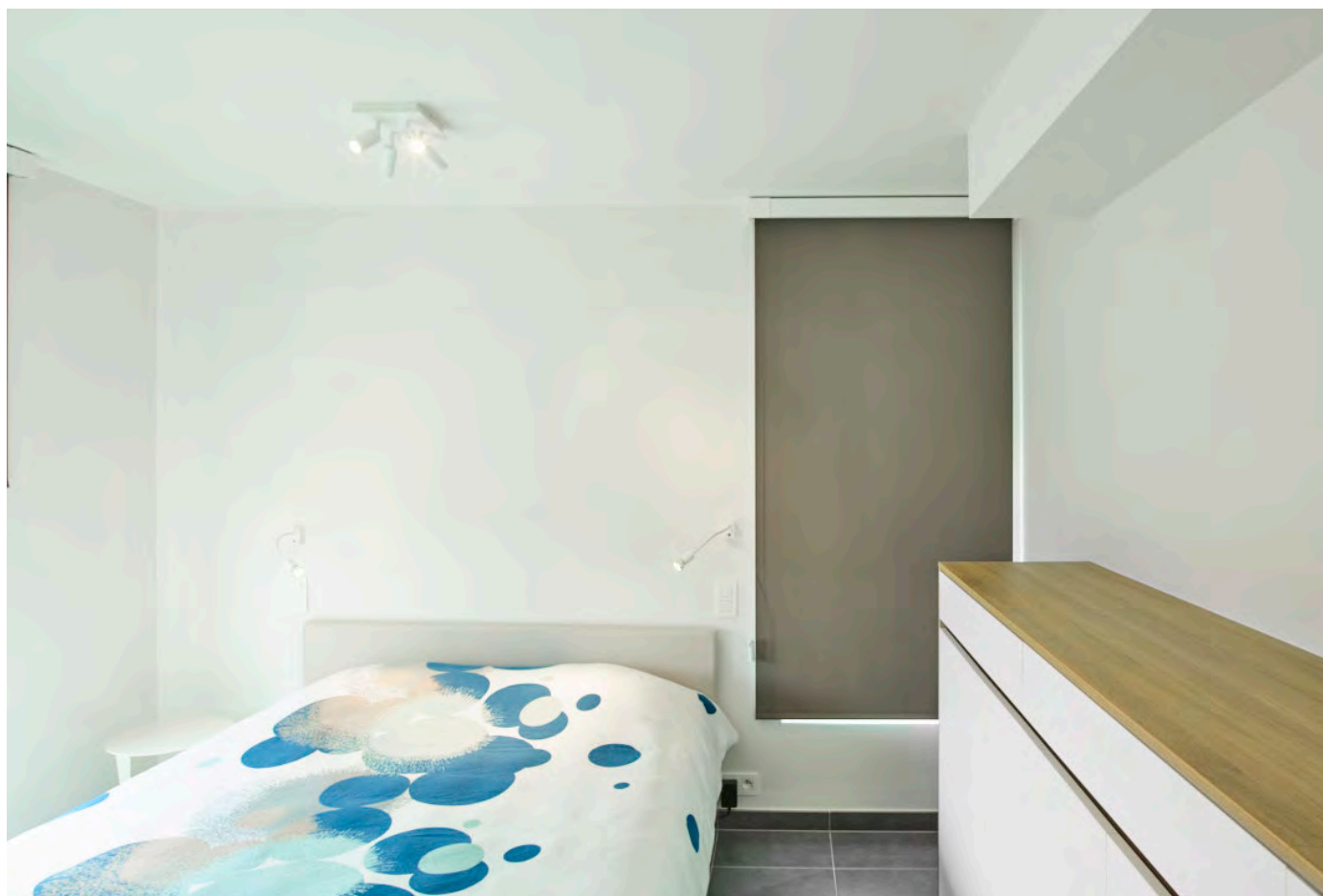



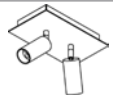

4522/.. - JACOBINE

~230V      1,0100  0,5 m  05.20.50 



built-up ceiling light - directional - with Texo base - with LED driver  
 Aufbau Deckenleuchte - schwenkbar - mit Texo Basis - mit Driver LED

**Lamp type**  
 2x led 467lm CRI80 max. 3,8W  -  350mA

**Dimensions**  
 L215xB130xH150  48° reflector  
 L180xB100

Ref	
4522.1M	NW   WW
4522.2M	NW   WW
4522.14	NW   WW
4522.29	WW

built-up  
 dimmable phase-cut  
 dimmbar Phasenabschnitt

4523/.. - JACOBINE

~230V      1,4600  0,5 m  05.20.50 

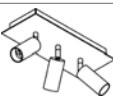

built-up ceiling light - directional - with Texo base - with LED driver  
 Aufbau Deckenleuchte - schwenkbar - mit Texo Basis - mit Driver LED

**Lamp type**  
 3x led 467lm CRI80 max. 3,8W  -  350mA

**Dimensions**  
 L300xB130xH150  48° reflector  
 L270xB100

Ref	
4523.1M	NW   WW
4523.2M	NW   WW
4523.14	NW   WW

built-up  
 dimmable phase-cut  
 dimmbar Phasenabschnitt

4524/.. - JACOBINE

~230V      1,8800  0,5 m  05.20.50 

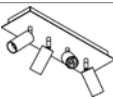

built-up ceiling light - directional - with Texo base - with LED driver  
 Aufbau Deckenleuchte - schwenkbar - mit Texo Basis - mit Driver LED

**Lamp type**  
 4x led 467lm CRI80 max. 3,8W  -  350mA

**Dimensions**  
 L385xB130xH150  48° reflector  
 L355xB100

Ref	
4524.1M	NW   WW
4524.2M	NW   WW
4524.14	NW   WW



built-up  
 dimmable phase-cut  
 dimmbar Phasenabschnitt

4525/.. - JACOBINE

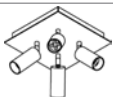
~230V      1,5000  0,5 m  05.20.50 



built-up ceiling light - directional - with Texo base - with LED driver  
 Aufbau Deckenleuchte - schwenkbar - mit Texo Basis - mit Driver LED





**Lamp type**  
 4x led 467lm CRI80 max. 3,8W  -  350mA

**Dimensions**  
 L210xB210xH150  48° reflector  
 L180xB180

Ref	
4525.1M	NW   WW
4525.2M	NW   WW
4525.14	NW   WW



built-up  
 dimmable phase-cut  
 dimmbar Phasenabschnitt

1743.AS.3/.. - THINDR

~230V  IP20  0,5 m  



built-up ceiling light - fixed - feeding asymmetric - with LED driver  
 Aufbau Deckenleuchte - fest - Energiequelle asymmetrisch - mit Driver LED



**Lamp type**  
 3x led 467lm CRI80 max. 3,8W  -  350mA

**Dimensions**  
 L500xB45xH380  
 Frame - L500xB300

Ref	
1743S.3.1M	NW   WW
1743S.3.2M	NW   WW
1743S.3.29	NW   WW
1743S.3.47	NW   WW
1743S.3.49	NW   WW
1743S.3.1M.16	NW   WW
1743S.3.2M.16	NW   WW
1743S.3.49.16	NW   WW
1743S.3.29.16	NW   WW
1743S.3.47.16	NW   WW



built-up

1743.CEN.3/.. - THINDR

~230V  IP20  0,5 m  



built-up ceiling light - fixed - central feeding - with LED driver  
 Aufbau Deckenleuchte - fest - Zentrale Energiequelle - mit Driver LED



**Lamp type**  
 3x led 467lm CRI80 max. 3,8W  -  350mA

**Dimensions**  
 L500xB45xH380  
 Frame - L500xB300

Ref	
1743.CEN.3.1M	NW   WW
1743.CEN.3.2M	NW   WW
1743.CEN.3.29	NW   WW
1743.CEN.3.47	NW   WW
1743.CEN.3.49	NW   WW
1743.CEN.3.1M.16	NW   WW
1743.CEN.3.2M.16	NW   WW
1743.CEN.3.49.16	NW   WW
1743.CEN.3.29.16	NW   WW
1743.CEN.3.47.16	NW   WW



built-up

1744.CEN.3/.. - THINDR

~230V  IP20  0,5 m  



built-up ceiling light - fixed - central feeding - with LED driver  
 Aufbau Deckenleuchte - fest - Zentrale Energiequelle - mit Driver LED

**Lamp type**  
 3x led 467lm CRI80 max. 3,8W  -  350mA

**Dimensions**  
 L500xB45xH380  
 Frame - L500xB300

Ref	
1744.CEN.3.1M	NW   WW
1744.CEN.3.2M	NW   WW
1744.CEN.3.29	NW   WW
1744.CEN.3.47	NW   WW
1744.CEN.3.49	NW   WW
1744.CEN.3.1M.16	NW   WW
1744.CEN.3.2M.16	NW   WW
1744.CEN.3.49.16	NW   WW
1744.CEN.3.29.16	NW   WW
1744.CEN.3.47.16	NW   WW



built-up

1746.CEN.5/.. - THINDR

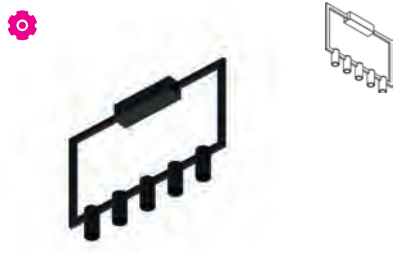
~230V  IP20  0,5 m  



built-up ceiling light - fixed - central feeding - with LED driver  
 Aufbau Deckenleuchte - fest - Zentrale Energiequelle - mit Driver LED

**Lamp type**  
 5x led 467lm CRI80 max. 3,8W  -  350mA







**Dimensions**  
 L500xB45xH380  
 Frame - L500xB300

Ref	
1746.CEN.5.1M	NW   WW
1746.CEN.5.2M	NW   WW
1746.CEN.5.29	NW   WW
1746.CEN.5.47	NW   WW
1746.CEN.5.49	NW   WW
1746.CEN.5.1M.16	NW   WW
1746.CEN.5.2M.16	NW   WW
1746.CEN.5.49.16	NW   WW
1746.CEN.5.29.16	NW   WW
1746.CEN.5.47.16	NW   WW

built-up





1745.AS.5/.. - THINDR

~230V   IP20     



built-up ceiling light - fixed - feeding asymmetric - with LED driver  
 Aufbau Deckenleuchte - fest - Energiequelle asymmetrisch - mit Driver LED

**Lamp type**  
 5x led 467lm CRI80 max. 3,8W  -  350mA







**Dimensions**  
 L700xB45xH380  
 Frame - L700xB300

**Ref**

1745S.5.1M	NW   WW
1745S.5.2M	NW   WW
1745S.5.29	NW   WW
1745S.5.47	NW   WW
1745S.5.49	NW   WW
1745S.5.1M.16	NW   WW
1745S.5.2M.16	NW   WW
1745S.5.49.16	NW   WW
1745S.5.29.16	NW   WW
1745S.5.47.16	NW   WW

built-up

1745.CEN.5/.. - THINDR

~230V   IP20     

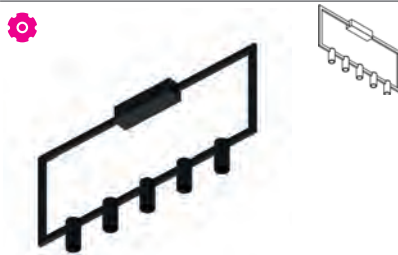

built-up ceiling light - fixed - central feeding - with LED driver  
 Aufbau Deckenleuchte - fest - Zentrale Energiequelle - mit Driver LED

**Lamp type**  
 5x led 467lm CRI80 max. 3,8W  -  350mA







**Dimensions**  
 L700xB45xH380  
 Frame - L700xB300

**Ref**

1745.CEN.5.1M	NW   WW
1745.CEN.5.2M	NW   WW
1745.CEN.5.29	NW   WW
1745.CEN.5.47	NW   WW
1745.CEN.5.49	NW   WW
1745.CEN.5.1M.16	NW   WW
1745.CEN.5.2M.16	NW   WW
1745.CEN.5.49.16	NW   WW
1745.CEN.5.29.16	NW   WW
1745.CEN.5.47.16	NW   WW

built-up

1747.AS.7/.. - THINDR

~230V   IP20     

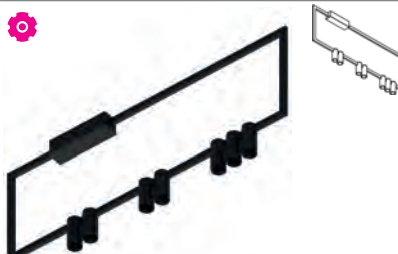

built-up ceiling light - fixed - feeding asymmetric - with LED driver  
 Aufbau Deckenleuchte - fest - Energiequelle asymmetrisch - mit Driver LED

**Lamp type**  
 7x led 467lm CRI80 max. 3,8W  -  350mA

**Dimensions**  
 L900xB45xH380  
 Frame - L900xB300

**Ref**

1747S.7.1M	NW   WW
1747S.7.2M	NW   WW
1747S.7.29	NW   WW
1747S.7.47	NW   WW
1747S.7.49	NW   WW
1747S.7.1M.16	NW   WW
1747S.7.2M.16	NW   WW
1747S.7.49.16	NW   WW
1747S.7.29.16	NW   WW
1747S.7.47.16	NW   WW

built-up

1747.CEN.7/.. - THINDR

~230V   IP20     

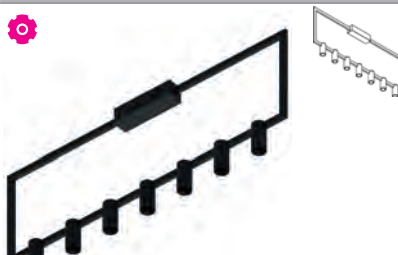

built-up ceiling light - fixed - central feeding - with LED driver  
 Aufbau Deckenleuchte - fest - Zentrale Energiequelle - mit Driver LED

**Lamp type**  
 7x led 467lm CRI80 max. 3,8W  -  350mA





**Dimensions**  
 L900xB45xH380  
 Frame - L900xB300

**Ref**

1747.CEN.7.1M	NW   WW
1747.CEN.7.2M	NW   WW
1747.CEN.7.29	NW   WW
1747.CEN.7.47	NW   WW
1747.CEN.7.49	NW   WW
1747.CEN.7.1M.16	NW   WW
1747.CEN.7.2M.16	NW   WW
1747.CEN.7.49.16	NW   WW
1747.CEN.7.29.16	NW   WW
1747.CEN.7.47.16	NW   WW

built-up

1749.AS.9/.. - THINDR

~230V  IP20  0,5 m  

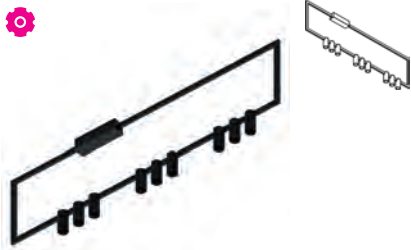

built-up





built-up ceiling light - fixed - feeding asymmetric - with LED driver  
 Aufbau Deckenleuchte - fest - Energiequelle asymmetrisch - mit Driver LED

**Lamp type**  
 9x led 467lm CRI80 max. 3,8W  -  350mA

**Dimensions**  
 L1200xB45xH380  
 Frame - L1200xB300

Ref	
1749S.9.1M	NW   WW
1749S.9.2M	NW   WW
1749S.9.29	NW   WW
1749S.9.47	NW   WW
1749S.9.49	NW   WW
1749S.9.1M.16	NW   WW
1749S.9.2M.16	NW   WW
1749S.9.49.16	NW   WW
1749S.9.29.16	NW   WW
1749S.9.47.16	NW   WW

1749.CEN.9/.. - THINDR

~230V  IP20  0,5 m  

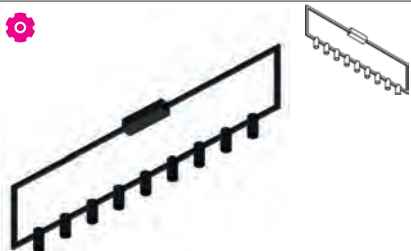

built-up

built-up ceiling light - fixed - central feeding - with LED driver  
 Aufbau Deckenleuchte - fest - Zentrale Energiequelle - mit Driver LED

**Lamp type**  
 9x led 467lm CRI80 max. 3,8W  -  350mA

**Dimensions**  
 L1200xB45xH380  
 Frame - L1200xB300

Ref	
1749.CEN.9.1M	NW   WW
1749.CEN.9.2M	NW   WW
1749.CEN.9.29	NW   WW
1749.CEN.9.47	NW   WW
1749.CEN.9.49	NW   WW
1749.CEN.9.1M.16	NW   WW
1749.CEN.9.2M.16	NW   WW
1749.CEN.9.49.16	NW   WW
1749.CEN.9.29.16	NW   WW
1749.CEN.9.47.16	NW   WW



1757.CEN.7/.. - THINDR CROSS

=350mA   IP20  0,5 m  



built-up

built-up ceiling light - fixed - central feeding - without LED driver  
 Aufbau Deckenleuchte - fest - Zentrale Energiequelle - ohne Driver LED

**Lamp type**  
 7x led 467lm CRI80 max. 3,8W  -  350mA







**Dimensions**  
 L700xB45xH380  
 Frame - L700xB300

Ref	
1757.CEN.7.1M	NW   WW
1757.CEN.7.2M	NW   WW
1757.CEN.7.29	NW   WW
1757.CEN.7.47	NW   WW
1757.CEN.7.49	NW   WW
1757.CEN.7.1M.16	NW   WW
1757.CEN.7.2M.16	NW   WW
1757.CEN.7.49.16	NW   WW
1757.CEN.7.29.16	NW   WW
1757.CEN.7.47.16	NW   WW







1733.CEN.3/.. - THINDR

~230V   IP20     



built-up ceiling light - fixed - central feeding - with LED driver  
 Aufbau Deckenleuchte - fest - Zentrale Energiequelle - mit Driver LED

Lamp type

 3x led 467lm CRI80 max. 3,8W  -  350mA

Dimensions







 L300xB45xH380  
 Frame - L300xB300

Ref

1733.CEN.3.1M	NW   WW
1733.CEN.3.2M	NW   WW
1733.CEN.3.29	NW   WW
1733.CEN.3.47	NW   WW
1733.CEN.3.49	NW   WW
1733.CEN.3.1M.16	NW   WW
1733.CEN.3.2M.16	NW   WW
1733.CEN.3.49.16	NW   WW
1733.CEN.3.29.16	NW   WW
1733.CEN.3.47.16	NW   WW

built-up



1735.CEN.5/.. - THINDR

~230V   IP20     



built-up ceiling light - fixed - central feeding - with LED driver  
 Aufbau Deckenleuchte - fest - Zentrale Energiequelle - mit Driver LED

Lamp type

 5x led 467lm CRI80 max. 3,8W  -  350mA

Dimensions







 L500xB45xH500  
 Frame - L500xB500

Ref

1735.CEN.5.1M	NW   WW
1735.CEN.5.2M	NW   WW
1735.CEN.5.29	NW   WW
1735.CEN.5.47	NW   WW
1735.CEN.5.49	NW   WW
1735.CEN.5.1M.16	NW   WW
1735.CEN.5.2M.16	NW   WW
1735.CEN.5.49.16	NW   WW
1735.CEN.5.29.16	NW   WW
1735.CEN.5.47.16	NW   WW

built-up

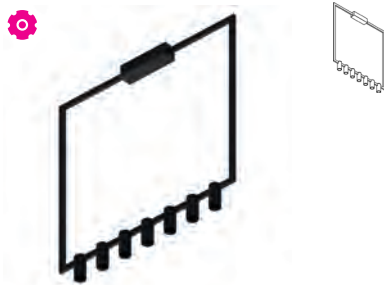

1737.CEN.7/.. - THINDR

~230V   IP20     



built-up ceiling light - fixed - central feeding - with LED driver  
 Aufbau Deckenleuchte - fest - Zentrale Energiequelle - mit Driver LED

Lamp type

 7x led 467lm CRI80 max. 3,8W  -  350mA

Dimensions

 L700xB45xH700  
 Frame - L700xB700

Ref

1737.CEN.7.1M	NW   WW
1737.CEN.7.2M	NW   WW
1737.CEN.7.29	NW   WW
1737.CEN.7.47	NW   WW
1737.CEN.7.49	NW   WW
1737.CEN.7.1M.16	NW   WW
1737.CEN.7.2M.16	NW   WW
1737.CEN.7.49.16	NW   WW
1737.CEN.7.29.16	NW   WW
1737.CEN.7.47.16	NW   WW

built-up

4078/.. - RICHARD ES50

~230V



built-up ceiling light - square - fixed - down  
Aufbau Deckenleuchte - viereckig - fest - down

Lamp type

1x QPAR70 GU10 max. 7W A+ 230V  
or 1x QPAR 51 GU10 max. 20W A+ - E 230V

Dimensions

L80xB80xH95

Materials

aluminium 1M | 2M

Ref

4078.1M white tex  
4078.2M black tex

built-up

4080/.. - RICHARD AR70

~230V



built-up ceiling light - square - fixed - down  
Aufbau Deckenleuchte - viereckig - fest - down

Lamp type

1x QPAR70 GU10 max. 8W A+ 230V  
or 1x QPAR 51 GU10 max. 20W A+ - E 230V

Dimensions

L90xB90xH95

Materials

aluminium 1M | 2M

Ref

4080.1M white tex  
4080.2M black tex

built-up

4077/.. - RICHARD AR70

~230V



built-up ceiling light - square - fixed - down  
Aufbau Deckenleuchte - viereckig - fest - down

Lamp type

1x QPAR70 GU10 max. 8W A+ 230V  
or 1x QPAR 51 GU10 max. 20W A+ - E 230V

Dimensions

L100xB100xH100

Materials

aluminium 1M | 2M

Ref

4077.1M white tex  
4077.2M black tex

built-up

4085/.. - RICHARD AR111

~230V



built-up ceiling light - square - fixed - down  
Aufbau Deckenleuchte - viereckig - fest - down

Lamp type

1x QPAR111 GU10 max. 12W A+ - D 230V

Dimensions

L120xB120xH120

Materials

aluminium 1M | 2M

Ref

4085.1M white tex  
4085.2M black tex

built-up

4079/.. - RICHARD SLA

~230V



IP20



0,5 m

05.20.50



built-up ceiling light - square - fixed - down - with LED module  
 Aufbau Deckenleuchte - viereckig - fest - down - mit LED-Modul

Ref

4079.1M

NW | WW

4079.2M

NW | WW

Lamptype

1x LED AC 700lm CRI92 max. 9,5W A+ 230V

Dimensions





L80xB80xH110  $\wedge$  36° reflector

built-up

LUMINAIRES



1419W/.. - CANVAS

~230V   IP20   1,8200 1 m 05.20.50 



ceiling light - with opal white glass  
Deckenleuchte - mit opalweißem Glas

**Lamp type**  
1x LED 1000lm CRI80 max. 12W 230V

**Dimensions**  
B200xH200xD63 180° reflector  
L125xB115

**Materials**  
aluminium 14 | 1M | 2M

**Ref**  
1419W.1M.WW white tex  
1419W.2M.WW black tex  
1419W.14.WW alu satin

built-up

8315/.. - STELLA

~230V  IP20    0,5 m 05.20.02 



built-up ceiling light - directional - with Capa spotlight  
Aufbau Deckenleuchte - schwenkbar - mit Capa Strahler

**Lamp type**  
1x QPAR 51 GU10 max. 20W A+ - E 230V  
or 1x QPAR70 GU10 max. 7W A+ 230V

**Dimensions**  
L123xB48xH142  
L123xB48xH47  
Bar - L55

**Materials**  
aluminium 14 | 1M | 2M | 45  
brass 4 | 16

**Ref**  
8315.1M white tex  
8315.2M black tex  
8315.4.2M shiny gold  
8315.14 alu satin  
8315.16.2M satin gold  
8315.45 sun gold

built-up  
lightbulb not included  
Leuchtmittel nicht einbegriffen

8316/.. - STELLA

~230V  IP20    0,4300 0,5 m 05.20.02 



built-up ceiling light - directional - With Capa X  
Aufbau Deckenleuchte - schwenkbar - mit Capa X

**Lamp type**  
1x QPAR 51 GU10 max. 20W A+ - E 230V

**Dimensions**  
L123xB48xH227  
L123xB48xH47  
Bar - L55

**Materials**  
aluminium 14 | 1M | 2M | 45  
brass 4 | 16

**Ref**  
8316.1M white tex  
8316.2M black tex  
8316.4 shiny gold  
8316.14 alu satin  
8316.16 satin gold  
8316.45 sun gold

built-up

8317/.. - STELLA

~230V   IP20    0,7500 0,5 m 05.20.50 



built-up ceiling light - directional - With Jacob - with LED driver  
Aufbau Deckenleuchte - schwenkbar - mit Jacob - mit Driver LED

**Lamp type**  
1x led 467lm CRI80 max. 3,8W A+ - A+ 350mA

**Dimensions**  
L123xB48xH187 48° reflector  
L123xB48xH47  
Bar - L55

**Ref**  
8317.1M NW | WW  
8317.2M NW | WW  
8317.2M.29 NW | WW  
8317.4.2M NW | WW  
8317.14 NW | WW  
8317.16.2M NW | WW  
8317.45.45 NW | WW

built-up

# INDOOR | Ceiling UP | Luminaires | STELLA

Built-up spot with rod colour 14 => joint colour 11

Aufbaustrahler mit Stange Farbe 14 => Kugelgelenk Farbe 11

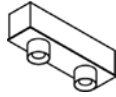

## 8318/.. - STELLA

~230V   IP20   0,5600 0,5 m 05.20.50 



built-up ceiling light - fixed - with round Zia Led - with LED driver  
 Aufbau Deckenleuchte - fest - mit Runde Zia Led - mit Driver LED

### Lamp type

2x led 467lm CRI80 max. 3,8W  -  350mA

### Dimensions

L183xB48xH65 

### Ref

8318.1M	NW   WW
8318.2M	NW   WW
8318.4.2M	NW   WW
8318.14	NW   WW
8318.16.2M	NW   WW
8318.45.45	NW   WW

built-up

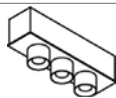

## 8319/.. - STELLA

~230V   IP20   0,5 m 05.20.50 



built-up ceiling light - fixed - with round Zia Led - with LED driver  
 Aufbau Deckenleuchte - fest - mit Runde Zia Led - mit Driver LED

### Lamp type

3x led 467lm CRI80 max. 3,8W  -  350mA

### Dimensions

L183xB48xH65 

### Ref

8319.1M	NW   WW
8319.2M	NW   WW
8319.4.2M	NW   WW
8319.14	NW   WW
8319.16.2M	NW   WW
8319.45.45	NW   WW

built-up

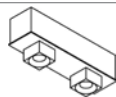

## 8343/.. - STELLA

~230V   IP20   0,5 m 05.20.50 



built-up ceiling light - fixed - with square Zia Led - with LED driver  
 Aufbau Deckenleuchte - fest - mit Viereckige Zia Led - mit Driver LED

### Lamp type

2x led 467lm CRI80 max. 3,8W  -  350mA

### Dimensions





L183xB48xH47 

### Ref

8343.1M	NW   WW
8343.2M	NW   WW
8343.4.2M	NW   WW
8343.14	NW   WW
8343.16.2M	NW   WW
8343.45.45	NW   WW

built-up

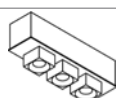

## 8344/.. - STELLA

~230V   IP20   0,5 m 05.20.50 



built-up ceiling light - fixed - with square Zia Led - with LED driver  
 Aufbau Deckenleuchte - fest - mit Viereckige Zia Led - mit Driver LED

### Lamp type

3x led 467lm CRI80 max. 3,8W  -  350mA

### Dimensions

L183xB48xH47 

### Ref

8344.1M	NW   WW
8344.2M	NW   WW
8344.4.2M	NW   WW
8344.14	NW   WW
8344.16.2M	NW   WW
8344.45.45	NW   WW

built-up



Built-up spot with rod colour 14 => joint colour 11

Aufbaustrahler mit Stange Farbe 14 => K ugelgelenk Farbe 11

8320/.. - STELLA

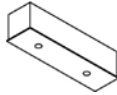

rectangular base for built-up spot or pendant  
rechteckige Basis f ur Aufbaustrahler oder H ngelampe

Dimensions

L183xB48xH47

Materials

aluminium 14 | 1M | 2M | 45  
brass 4 | 16

Ref

8320.1M	white tex
8320.2M	black tex
8320.4.2M	shiny gold
8320.14	alu satin
8320.16.2M	satin gold
8320.45	sun gold

built-up  
spots to be ordered separately  
Spotlights separat zu bestellen

8321/.. - STELLA

~230V

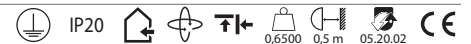

built-up ceiling light - directional - with Capa spotlight  
Aufbau Deckenleuchte - schwenkbar - mit Capa Strahler

Lamp type

2x QPAR 51 GU10 max. 20W A+ - E 230V

or 2x QPAR70 GU10 max. 7W A+ 230V

Dimensions

L183xB48xH142

L183xB48xH47

Bar - L55

Materials

aluminium 14 | 1M | 2M | 45  
brass 4 | 16

Ref

8321.1M	white tex
8321.2M	black tex
8321.4.2M	shiny gold
8321.14	alu satin
8321.16.2M	satin gold
8321.45	sun gold

built-up

8322/.. - STELLA

~230V



built-up ceiling light - directional - With Capa X  
Aufbau Deckenleuchte - schwenkbar - mit Capa X

Lamp type

2x QPAR 51 GU10 max. 20W A+ - E 230V

Dimensions

L183xB48xH227

L183xB48xH47

Bar - L55

Materials

aluminium 14 | 1M | 2M | 45  
brass 4 | 16

Ref

8322.1M	white tex
8322.2M	black tex
8322.4.2M	shiny gold
8322.14	alu satin
8322.16.2M	satin gold
8322.45	sun gold

built-up

8323/.. - STELLA

~230V



built-up ceiling light - directional - With Jacob - with LED  
driver  
Aufbau Deckenleuchte - schwenkbar - mit Jacob - mit Driver  
LED

Lamp type

2x led 467lm CRI80 max. 3,8W A+ - A+ 350mA

Dimensions

L183xB48xH187 48° reflector

L183xB48xH47

Bar - L55

Ref

8323.1M	NW   WW
8323.2M	NW   WW
8323.2M.29	NW   WW
8323.4.2M	NW   WW
8323.14	NW   WW
8323.16.2M	NW   WW
8323.45.45	NW   WW

built-up

# INDOOR | Ceiling UP | Luminaires | STELLA

Built-up spot with rod colour 14 => joint colour 11

Aufbaustrahler mit Stange Farbe 14 => Kugelgelenk Farbe 11

## 8324/.. - STELLA

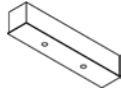

rectangular base for built-up spot or pendant  
rechteckige Basis fur Aufbaustrahler oder Hangelampe

**Dimensions**

L243xB48xH47

**Materials**

aluminium 14 | 1M | 2M | 45  
brass 4 | 16

**Ref**

8324.1M	white tex
8324.2M	black tex
8324.4.2M	shiny gold
8324.14	alu satin
8324.16.2M	satin gold
8324.45	sun gold

*built-up  
spots to be ordered separately  
Spotlights separat zu bestellen*

## 8325/.. - STELLA

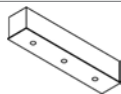

rectangular base for built-up spot or pendant  
rechteckige Basis fur Aufbaustrahler oder Hangelampe

**Dimensions**

L243xB48xH47

**Materials**

aluminium 14 | 1M | 2M | 45  
brass 4 | 16

**Ref**

8325.1M	white tex
8325.2M	black tex
8325.4.2M	shiny gold
8325.14	alu satin
8325.16.2M	satin gold
8325.45	sun gold

*built-up  
spots to be ordered separately  
Spotlights separat zu bestellen*

## 8326/.. - STELLA

~230V

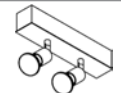

built-up ceiling light - directional - with Capa spotlight  
Aufbau Deckenleuchte - schwenkbar - mit Capa Strahler

**Lamp type**

2x QPAR 51 GU10 max. 20W A+ - E 230V  
or 2x QPAR70 GU10 max. 7W A+ 230V

**Dimensions**

L243xB48xH142  
L243xB48xH47

Bar - L55

**Materials**

aluminium 14 | 1M | 2M | 45  
brass 4 | 16

**Ref**

8326.1M	white tex
8326.2M	black tex
8326.4.2M	shiny gold
8326.14	alu satin
8326.16.2M	satin gold
8326.45	sun gold

*built-up*

## 8327/.. - STELLA

~230V

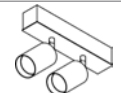

built-up ceiling light - directional - With Capa X  
Aufbau Deckenleuchte - schwenkbar - mit Capa X

**Lamp type**

2x QPAR 51 GU10 max. 20W A+ - E 230V

**Dimensions**

L243xB48xH227  
L243xB48xH47

Bar - L55

**Materials**

aluminium 14 | 1M | 2M | 45  
brass 4 | 16

**Ref**

8327.1M	white tex
8327.2M	black tex
8327.4	shiny gold
8327.14	alu satin
8327.16	satin gold
8327.45	sun gold

*built-up*



# INDOOR | Ceiling UP | Luminaires | STELLA

Built-up spot with rod colour 14 => joint colour 11

Aufbaustrahler mit Stange Farbe 14 => Kugelgelenk Farbe 11

## 8328/.. - STELLA

~230V

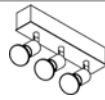

built-up ceiling light - directional - with Capa spotlight  
Aufbau Deckenleuchte - schwenkbar - mit Capa Strahler

### Lamp type

3x QPAR 51 GU10 max. 20W **A+** - **E** 230V  
or 3x QPAR70 GU10 max. 7W **A+** 230V

### Dimensions

L243xB48xH142  
L243xB48xH47

Bar - L55

### Materials

aluminium 14 | 1M | 2M | 45  
brass 4 | 16

### Ref

8328.1M	white tex
8328.2M	black tex
8328.4.2M	shiny gold
8328.14	alu satin
8328.16.2M	satin gold
8328.45	sun gold

built-up

## 8329/.. - STELLA

~230V

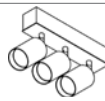
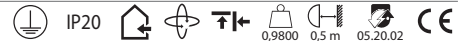

built-up ceiling light - directional - With Capa X  
Aufbau Deckenleuchte - schwenkbar - mit Capa X

### Lamp type

3x QPAR 51 GU10 max. 20W **A+** - **E** 230V

### Dimensions

L243xB48xH227  
L243xB48xH47

Bar - L55

### Materials

aluminium 14 | 1M | 2M | 45  
brass 4 | 16

### Ref

8329.1M	white tex
8329.2M	black tex
8329.4	shiny gold
8329.14	alu satin
8329.16	satin gold
8329.45	sun gold

built-up

## 8330/.. - STELLA

~230V

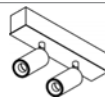

built-up ceiling light - directional - With Jacob - with LED driver  
Aufbau Deckenleuchte - schwenkbar - mit Jacob - mit Driver LED

### Lamp type

2x led 467lm CRI80 max. 3,8W **A+** - **A+** 350mA

### Dimensions

L243xB48xH187  $\wedge$  48° reflector  
L243xB48xH47

Bar - L55

### Ref

8330.1M	NW   WW
8330.2M	NW   WW
8330.2M.29	NW   WW
8330.4.2M	NW   WW
8330.14	NW   WW
8330.16.2M	NW   WW
8330.45.45	NW   WW

built-up

## 8331/.. - STELLA

~230V

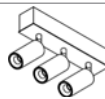

built-up ceiling light - directional - With Jacob - with LED driver  
Aufbau Deckenleuchte - schwenkbar - mit Jacob - mit Driver LED

### Lamp type

3x led 467lm CRI80 max. 3,8W **A+** - **A+** 350mA

### Dimensions

L243xB48xH187  $\wedge$  48° reflector  
L243xB48xH47

Bar - L55

### Ref

8331.1M	NW   WW
8331.2M	NW   WW
8331.2M.29	NW   WW
8331.4.2M	NW   WW
8331.14	NW   WW
8331.16.2M	NW   WW
8331.45.45	NW   WW

built-up



Built-up spot with rod colour 14 => joint colour 11

Aufbaustrahler mit Stange Farbe 14 => Kugelgelenk Farbe 11

8332/.. - STELLA

~230V

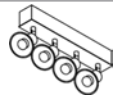

built-up ceiling light - directional - with Capa spotlight  
Aufbau Deckenleuchte - schwenkbar - mit Capa Strahler

Lamp type

4x QPAR 51 GU10 max. 20W A+ - E 230V

or 4x QPAR70 GU10 max. 7W A+ 230V

Dimensions

L303xB48xH142

L303xB48xH47

Bar - L55

Materials

aluminium 14 | 1M | 2M | 45

brass 4 | 16

Ref

8332.1M	white tex
8332.2M	black tex
8332.4.2M	shiny gold
8332.14	alu satin
8332.16.2M	satin gold
8332.45	sun gold

built-up

8333/.. - STELLA

~230V

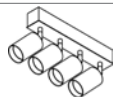

built-up ceiling light - directional - With Capa X  
Aufbau Deckenleuchte - schwenkbar - mit Capa X

Lamp type

4x QPAR 51 GU10 max. 20W A+ - E 230V

Dimensions

L303xB48xH227

L303xB48xH47

Bar - L55

Materials

aluminium 14 | 1M | 2M | 45

brass 4 | 16

Ref

8333.1M	white tex
8333.2M	black tex
8333.4.2M	shiny gold
8333.14	alu satin
8333.16.2M	satin gold
8333.45	sun gold

built-up





# INDOOR | Ceiling UP | Luminaires | STELLA

Built-up spot with rod colour 14 => joint colour 11

Aufbaustrahler mit Stange Farbe 14 => Kugelgelenk Farbe 11

## 8334/.. - STELLA

~230V

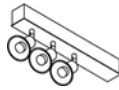

built-up ceiling light - directional - with Capa spotlight  
Aufbau Deckenleuchte - schwenkbar - mit Capa Strahler

### Lamp type

3x QPAR 51 GU10 max. 20W A+ - E 230V

or 3x QPAR70 GU10 max. 7W A+ 230V

### Dimensions

L363xB48xH142

L363xB48xH47

Bar - L55

### Materials

aluminium 14 | 1M | 2M | 45

brass 4 | 16

### Ref

8334.1M	white tex
8334.2M	black tex
8334.4.2M	shiny gold
8334.14	alu satin
8334.16.2M	satin gold
8334.45	sun gold

built-up

## 8335/.. - STELLA

~230V

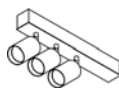
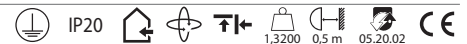

built-up ceiling light - directional - With Capa X  
Aufbau Deckenleuchte - schwenkbar - mit Capa X

### Lamp type

3x QPAR 51 GU10 max. 20W A+ - E 230V

### Dimensions

L363xB48xH227

L363xB48xH47

Bar - L55

### Materials

aluminium 14 | 1M | 2M | 45

brass 4 | 16

### Ref

8335.1M	white tex
8335.2M	black tex
8335.4.2M	shiny gold
8335.14	alu satin
8335.16.2M	satin gold
8335.45	sun gold

built-up

## 8336/.. - STELLA

~230V

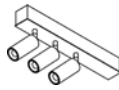

built-up ceiling light - directional - With Jacob - with LED driver  
Aufbau Deckenleuchte - schwenkbar - mit Jacob - mit Driver LED

### Lamp type

3x led 467lm CRI80 max. 3,8W A+ - A+ 350mA

### Dimensions

L363xB48xH187 ∧ 48° reflector

L363xB48xH47

Bar - L55

### Ref

8336.1M	NW   WW
8336.2M	NW   WW
8336.2M.29	NW   WW
8336.4.2M	NW   WW
8336.14	NW   WW
8336.16.2M	NW   WW
8336.45.45	NW   WW

built-up

Built-up spot with rod colour 14 => joint colour 11



Aufbaustrahler mit Stange Farbe 14 => Kugelgelenk Farbe 11

8337/.. - STELLA

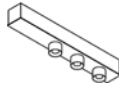
~230V   IP20     



built-up ceiling light - fixed - with round Zia Led - with LED driver  
 Aufbau Deckenleuchte - fest - mit Runde Zia Led - mit Driver LED

**Lamp type**  
 3x led 467lm CRI80 max. 3,8W  -  350mA

**Dimensions**  
 L363xB48xH65 

Ref	
8337.1M	NW   WW
8337.2M	NW   WW
8337.14	NW   WW
8337.45	NW   WW



built-up

8338/.. - STELLA

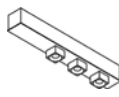
~230V   IP20     



built-up ceiling light - fixed - with square Zia Led - with LED driver  
 Aufbau Deckenleuchte - fest - mit Viereckige Zia Led - mit Driver LED

**Lamp type**  
 3x led 467lm CRI80 max. 3,8W  -  350mA

**Dimensions**  
 L363xB48xH65 

Ref	
8338.1M	NW   WW
8338.2M	NW   WW
8338.14	NW   WW
8338.45	NW   WW



built-up

8339/.. - STELLA

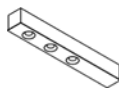
~230V   IP20      



built-up ceiling light - fixed - with 3 round recessed spotlights - with LED driver  
 Aufbau Deckenleuchte - fest - mit 3 runden Einbaustrahlern - mit Driver LED

**Lamp type**  
 3x led 467lm CRI80 max. 3,8W  -  350mA

**Dimensions**  
 L363xB48xH45 

Ref	
8339.1M	NW   WW
8339.2M	NW   WW
8339.14	NW   WW
8339.45	NW   WW

built-up







8340/.. - STELLA



~230V   IP20     





built-up ceiling light - fixed - with round Zia Led - with LED driver  
 Aufbau Deckenleuchte - fest - mit Runde Zia Led - mit Driver LED

**Ref**  
 8340.1M NW | WW  
 8340.2M NW | WW

**Lamp type**

 4x led 467lm CRI80 max. 3,8W  -  350mA

**Dimensions**

 L200xB200xH65  48° reflector  
 L170xB170xH45

built-up

8341/.. - STELLA

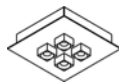

~230V   IP20      





built-up ceiling light - fixed - with square Zia Led - with LED driver  
 Aufbau Deckenleuchte - fest - mit Viereckige Zia Led - mit Driver LED

**Ref**  
 8341.1M NW | WW  
 8341.2M NW | WW

**Lamp type**

 4x led 467lm CRI80 max. 3,8W  -  350mA

**Dimensions**

 L200xB200xH65  48° reflector  
 L170xB170xH45

built-up

8342/.. - STELLA



~230V   IP20     





built-up ceiling light - fixed - with 4 round recessed spotlights  
 - with LED driver  
 Aufbau Deckenleuchte - fest - mit 4 runden Einbaustrahlern  
 - mit Driver LED

**Ref**  
 8342.1M NW | WW  
 8342.2M NW | WW

**Lamp type**

 4x led 467lm CRI80 max. 3,8W  -  350mA

**Dimensions**

 L200xB200xH47  48° reflector  
 L170xB170xH45

built-up

8345/.. - STELLA



~230V   IP20       





built-up ceiling light - directional - with 4 round recessed spotlights - with LED driver  
 Aufbau Deckenleuchte - schwenkbar - mit 4 runden Einbaustrahlern - mit Driver LED

**Ref**  
 8345.1M NW | WW  
 8345.2M NW | WW  
 8345.29 NW | WW  
 8345.49 NW | WW

**Lamp type**

 4x led 467lm CRI80 max. 3,8W  -  350mA

**Dimensions**

 L200xB200xH65  48° reflector  
 L170xB170xH45

built-up

621.ES50/.. - CUPIDO I

~230V



IP20



0,5180



1 m



05.20.02



built-up ceiling light - directional - cone Ø65 H70  
Aufbau Deckenleuchte - schwenkbar - Kelch Ø65 H70

Lamp type

1x QPAR 51 GU10 max. 20W A+ - E 230V

Dimensions

Ø140xH115

Ø100

Materials

aluminium 1 | 2 | 11 | 14 | 1M | 2M

Ref

621.ES50.1.1	white
621.ES50.1M	white tex
621.ES50.2.7	black
621.ES50.2.40	black
621.ES50.2M	black tex
621.ES50.11.40	alu grey
621.ES50.14.40	alu satin

built-up

622.ES50/.. - CUPIDO II

~230V



IP20



0,9580



1 m



05.20.02



built-up ceiling light - directional - cone Ø65 H70  
Aufbau Deckenleuchte - schwenkbar - Kelch Ø65 H70

Lamp type

2x QPAR 51 GU10 max. 20W A+ - E 230V

Dimensions

Ø240xH105

Ø175

Materials

aluminium 1 | 2 | 11 | 14 | 1M | 2M

Ref

622.ES50.1.1	white
622.ES50.1M	white tex
622.ES50.2.7	black
622.ES50.2.40	black
622.ES50.2M	black tex
622.ES50.11.40	alu grey
622.ES50.14.40	alu satin

built-up

623.ES50/.. - CUPIDO III

~230V



IP20



1,9730



1 m



05.20.02



built-up ceiling light - directional - cone Ø65 H70  
Aufbau Deckenleuchte - schwenkbar - Kelch Ø65 H70

Lamp type

3x QPAR 51 GU10 max. 20W A+ - E 230V

Dimensions

Ø320xH105

Ø215

Materials

aluminium 1 | 2 | 11 | 14 | 1M | 2M

Ref

623.ES50.1.1	white
623.ES50.1M	white tex
623.ES50.2.7	black
623.ES50.2.40	black
623.ES50.2M	black tex
623.ES50.11.40	alu grey
623.ES50.14.40	alu satin

built-up

624.ES50/.. - CUPIDO IV

~230V



IP20



1,5920



1 m



05.20.02



built-up ceiling light - directional - cone Ø65 H70  
Aufbau Deckenleuchte - schwenkbar - Kelch Ø65 H70

Lamp type

4x QPAR 51 GU10 max. 20W A+ - E 230V

Dimensions

Ø320xH105

Ø245

Materials

aluminium 1 | 2 | 11 | 14 | 1M | 2M

Ref

624.ES50.1.1	white
624.ES50.1M	white tex
624.ES50.2.7	black
624.ES50.2.40	black
624.ES50.2M	black tex
624.ES50.11.40	alu grey
624.ES50.14.40	alu satin

built-up



621.AR70/.. - CUPIDO I

~230V   IP20     0,5 m  05.20.02  CE



built-up ceiling light - directional - cone Ø78 H85 - without transformer  
 Aufbau Deckenleuchte - schwenkbar - Kelch Ø78 H85 - ohne Trafo

**Lamp type**  
 1x QPAR70 GU10 max. 7W  230V

**Dimensions**  
 Ø140xH130  
 Ø100

**Materials**  
 aluminium 1 | 2 | 11 | 14 | 1M | 2M

Ref	
621.AR70.1.1	white
621.AR70.1.M	white tex
621.AR70.2.7	black
621.AR70.2.40	black
621.AR70.2.M	black tex
621.AR70.11.40	alu grey
621.AR70.14.40	alu satin

built-up

625.AR70/.. - CUPIDO I

~230V  IP20     0,5 m  05.20.02  CE



built-up ceiling light - directional - cone Ø78 H85  
 Aufbau Deckenleuchte - schwenkbar - Kelch Ø78 H85

**Lamp type**  
 1x QPAR70 GU10 max. 7W  230V

**Dimensions**  
 Ø140xH160  
 Ø100

**Materials**  
 aluminium 1 | 2 | 11 | 14 | 1M | 2M

Ref	
625.AR70.1.1	white
625.AR70.1.M	white tex
625.AR70.2.7	black
625.AR70.2.40	black
625.AR70.2.M	black tex
625.AR70.11.40	alu grey
625.AR70.14.40	alu satin

built-up

622.AR70/.. - CUPIDO II

~230V   IP20     0,5 m  05.20.02  CE



built-up ceiling light - directional - cone Ø78 H85 - without transformer  
 Aufbau Deckenleuchte - schwenkbar - Kelch Ø78 H85 - ohne Trafo

**Lamp type**  
 2x QPAR70 GU10 max. 7W  230V

**Dimensions**  
 Ø240xH120  
 Ø175

**Materials**  
 aluminium 1 | 2 | 11 | 14 | 1M | 2M

Ref	
622.AR70.1.1	white
622.AR70.1.M	white tex
622.AR70.2.7	black
622.AR70.2.40	black
622.AR70.2.M	black tex
622.AR70.11.40	alu grey
622.AR70.14.40	alu satin

built-up

623.AR70/.. - CUPIDO III

~230V   IP20     2,5250  0,5 m  05.20.02  CE



built-up ceiling light - directional - cone Ø78 H85 - without transformer  
 Aufbau Deckenleuchte - schwenkbar - Kelch Ø78 H85 - ohne Trafo

**Lamp type**  
 3x QPAR70 GU10 max. 7W  230V

**Dimensions**  
 Ø320xH132  
 Ø215

**Materials**  
 aluminium 1 | 2 | 11 | 14 | 1M | 2M

Ref	
623.AR70.1.1	white
623.AR70.1.M	white tex
623.AR70.2.7	black
623.AR70.2.40	black
623.AR70.2.M	black tex
623.AR70.11.40	alu grey
623.AR70.14.40	alu satin

built-up

624.AR70/.. - CUPIDO IV

~230V



IP20



0,5 m



05.20.02



built-up ceiling light - directional - cone Ø78 H85 - without transformer  
 Aufbau Deckenleuchte - schwenkbar - Kelch Ø78 H85 - ohne Trafo

**Lamp type**

4x QPAR70 GU10 max. 7W A+ 230V

**Dimensions**

Ø320xH132

Ø245

**Materials**

aluminium 1 | 2 | 11 | 14 | 1M | 2M

**Ref**

624.AR70.1.1	white
624.AR70.1M	white tex
624.AR70.2.7	black
624.AR70.2.40	black
624.AR70.2M	black tex
624.AR70.11.40	alu grey
624.AR70.14.40	alu satin

built-up

LUMINAIRES





978/.. - CUBIC

~230V   IP20     0,4450  0,5 m  05.20.02 



built-up ceiling light - directional - with transformer  
Aufbau Deckenleuchte - schwenkbar - mit Trafo

Ref  
978.14 alu satin

**Lamp type**  
1x QR-CB 51 GU5,3/GX5,3 max. 50W  -  12V

**Dimensions**  
L60xB60xH180  
L60xB60xH67

**Materials**  
aluminium 14

built-up  
with LED-transfo  
mit LED-Trafo



979/.. - CUBIC

~12V   IP20     0,2550  0,5 m  05.20.02 



built-up ceiling light - directional - without transformer  
Aufbau Deckenleuchte - schwenkbar - ohne Trafo

Ref  
979.14 alu satin

**Lamp type**  
1x QR-CB 51 GU5,3/GX5,3 max. 50W  -  12V

**Dimensions**  
L60xB60xH102  
L60xB60xH25

**Materials**  
aluminium 14

built-up



981/.. - CUBIC

~230V   IP20     0,5500  0,5 m  05.20.02 



built-up ceiling light - directional - with transformer  
Aufbau Deckenleuchte - schwenkbar - mit Trafo

Ref  
981.14 alu satin

**Lamp type**  
1x QR-CB 51 GU5,3/GX5,3 max. 50W  -  12V

**Dimensions**  
L115xB70xH125  
L93xB50xH43

**Materials**  
aluminium 14

built-up  
with LED-transfo  
mit LED-Trafo



982/.. - CUBIC

~230V   IP20     1,2000  0,5 m  05.20.02 



built-up ceiling light - directional - with transformer  
Aufbau Deckenleuchte - schwenkbar - mit Trafo

Ref  
982.14 alu satin

**Lamp type**  
2x QR-CB 51 GU5,3/GX5,3 max. 50W  -  12V

**Dimensions**  
L200xB125xH125  
L160xB95xH31

**Materials**  
aluminium 14

built-up  
with LED-transfo  
mit LED-Trafo



983/.. - CUBIC

~230V   IP20     2,0000  0,5 m  05.20.02 



built-up ceiling light - directional - with transformer  
Aufbau Deckenleuchte - schwenkbar - mit Trafo

Ref  
983.14 alu satin

**Lamp type**  
3x QR-CB 51 GU5,3/GX5,3 max. 50W  -  12V

**Dimensions**  
L340xB125xH125  
L302xB95xH32

**Materials**  
aluminium 14

built-up  
with LED-transfo  
mit LED-trafo

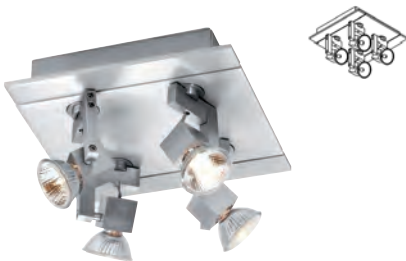

984/.. - CUBIC

~230V   IP20     2,3600  0,5 m  05.20.02 



built-up ceiling light - directional - with transformer  
Aufbau Deckenleuchte - schwenkbar - mit Trafo

Ref  
984.14 alu satin

**Lamp type**  
4x QR-CB 51 GU5,3/GX5,3 max. 50W  -  12V

**Dimensions**  
L215xB215xH125  
L193xB170xH32

**Materials**  
aluminium 14

built-up  
with LED-transfo  
mit LED-Trafo

616.ES50.45/.. - ZOOM CLICK + VOLTA

~230V  IP20     1,3950  1 m  05.20.02 



built-up ceiling light - directional - cone Ø65 H70  
Aufbau Deckenleuchte - schwenkbar - Kelch Ø65 H70

Ref  
616.ES50.45.1.1 white  
616.ES50.45.1M.1M white tex  
616.ES50.45.2.7 black  
616.ES50.45.2.40 black  
616.ES50.45.2M.1M black tex  
616.ES50.45.11.40 alu grey  
616.ES50.45.14.40 alu satin

**Lamp type**  
1x QPAR 51 GU10 max. 20W  -  230V

**Dimensions**  
L180xB180xH115  
L140xB140

**Materials**  
aluminium 1 | 2 | 11 | 14 | 1M | 2M

built-up

617.ES50.45/.. - ZOOM CLICK + VOLTA

~230V  IP20     2,4200  1 m  05.20.02 



built-up ceiling light - directional - cone Ø65 H70  
Aufbau Deckenleuchte - schwenkbar - Kelch Ø65 H70

Ref  
617.ES50.45.1.1 white  
617.ES50.45.1M.1M white tex  
617.ES50.45.2.7 black  
617.ES50.45.2.40 black  
617.ES50.45.2M.1M black tex  
617.ES50.45.2M.14.40 black tex  
617.ES50.45.11.40 alu grey  
617.ES50.45.14.40 alu satin

**Lamp type**  
2x QPAR 51 GU10 max. 20W  -  230V

**Dimensions**  
L340xB200xH115  
L270xB130

**Materials**  
aluminium 1 | 2 | 11 | 14 | 1M | 2M

built-up

618.ES50.45/.. - ZOOM CLICK + VOLTA

~230V



built-up ceiling light - directional - cone Ø65 H70  
Aufbau Deckenleuchte - schwenkbar - Kelch Ø65 H70

Lamp type

3x QPAR 51 GU10 max. 20W A+ - E 230V

Dimensions

L480xB200xH115

L410xB130

Materials

aluminium 1 | 2 | 11 | 14 | 1M | 2M

Ref

618.ES50.45.1.1	white
618.ES50.45.1M.1M	white tex
618.ES50.45.2.7	black
618.ES50.45.2.40	black
618.ES50.45.2M.1M	black tex
618.ES50.45.11.40	alu grey
618.ES50.45.14.40	alu satin

built-up

619.ES50.45/.. - ZOOM CLICK + VOLTA

~230V



built-up ceiling light - directional - cone Ø65 H70  
Aufbau Deckenleuchte - schwenkbar - Kelch Ø65 H70

Lamp type

4x QPAR 51 GU10 max. 20W A+ - E 230V

Dimensions

L620xB200xH115

L550xB130

Materials

aluminium 1 | 2 | 11 | 14 | 1M | 2M

Ref

619.ES50.45.1.1	white
619.ES50.45.1M.1M	white tex
619.ES50.45.2.7	black
619.ES50.45.2.40	black
619.ES50.45.2M.1M	black tex
619.ES50.45.2M.14.40	black tex
619.ES50.45.11.40	alu grey
619.ES50.45.14.40	alu satin

built-up

620.ES50.45/.. - ZOOM CLICK + VOLTA

~230V



built-up ceiling light - directional - cone Ø65 H70  
Aufbau Deckenleuchte - schwenkbar - Kelch Ø65 H70

Lamp type

4x QPAR 51 GU10 max. 20W A+ - E 230V

Dimensions

L340xB340xH115

L260xB260

Materials

aluminium 1 | 2 | 11 | 14 | 1M | 2M

Ref

620.ES50.45.1.1	white
620.ES50.45.1M.1M	white tex
620.ES50.45.2.7	black
620.ES50.45.2.40	black
620.ES50.45.2M.1M	black tex
620.ES50.45.2M.14.40	black tex
620.ES50.45.11.40	alu grey
620.ES50.45.14.40	alu satin

built-up



616.AR70.45/.. - ZOOM CLICK + VOLTA

~230V



built-up ceiling light - directional - cone Ø78 H85 - with transformer  
 Aufbau Deckenleuchte - schwenkbar - Kelch Ø78 H85 - mit Trafo

Lamp type

1x QR-LP70 BA15d max. 50W A+ - E 12V

Dimensions

L180xB180xH130

L140xB140

Materials

aluminium 1 | 2 | 11 | 14 | 1M | 2M

Ref

616.AR70.45.1.1	white
616.AR70.45.1M.1M	white tex
616.AR70.45.2.7	black
616.AR70.45.2.40	black
616.AR70.45.2M.1M	black tex
616.AR70.45.11.40	alu grey
616.AR70.45.14.40	alu satin

built-up  
 with LED-transformer  
 mit LED-Trafo

617.AR70.45/.. - ZOOM CLICK + VOLTA

~230V



built-up ceiling light - directional - cone Ø78 H85 - with transformer  
 Aufbau Deckenleuchte - schwenkbar - Kelch Ø78 H85 - mit Trafo

Lamp type

2x QR-LP70 BA15d max. 50W A+ - E 12V

Dimensions

L340xB200xH130

L270xB130

Materials

aluminium 1 | 2 | 11 | 14 | 1M | 2M

Ref

617.AR70.45.1.1	white
617.AR70.45.1M.1M	white tex
617.AR70.45.2.7	black
617.AR70.45.2.40	black
617.AR70.45.2M.1M	black tex
617.AR70.45.11.40	alu grey
617.AR70.45.14.40	alu satin

built-up  
 with LED-transformer  
 mit LED-Trafo

618.AR70.45/.. - ZOOM CLICK + VOLTA

~230V



built-up ceiling light - directional - cone Ø78 H85 - with transformer  
 Aufbau Deckenleuchte - schwenkbar - Kelch Ø78 H85 - mit Trafo

Lamp type

3x QR-LP70 BA15d max. 50W A+ - E 12V

Dimensions

L480xB200xH130

L410xB130

Materials

aluminium 1 | 2 | 11 | 14 | 1M | 2M

Ref

618.AR70.45.1.1	white
618.AR70.45.1M.1M	white tex
618.AR70.45.2.7	black
618.AR70.45.2.40	black
618.AR70.45.2M.1M	black tex
618.AR70.45.11.40	alu grey
618.AR70.45.14.40	alu satin

built-up  
 with LED-transformer  
 mit LED-Trafo

619.AR70.45/.. - ZOOM CLICK + VOLTA

~230V

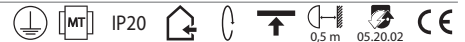

built-up ceiling light - directional - cone Ø78 H85 - with transformer  
 Aufbau Deckenleuchte - schwenkbar - Kelch Ø78 H85 - mit Trafo

Lamp type

4x QR-LP70 BA15d max. 50W A+ - E 12V

Dimensions

L620xB200xH130

L550xB130

Materials

aluminium 1 | 2 | 11 | 14 | 1M | 2M

Ref

619.AR70.45.1.1	white
619.AR70.45.1M.1M	white tex
619.AR70.45.2.7	black
619.AR70.45.2.40	black
619.AR70.45.2M.1M	black tex
619.AR70.45.11.40	alu grey
619.AR70.45.14.40	alu satin

built-up  
 with LED-transformer  
 mit LED-Trafo

620.AR70.45/.. - ZOOM CLICK + VOLTA

~230V



IP20



4.3800 0.5 m 05.20.02



built-up ceiling light - directional - cone Ø78 H85 - with transformer  
 Aufbau Deckenleuchte - schwenkbar - Kelch Ø78 H85 - mit Trafo

**Lamp type**

4x QR-LP70 BA15d max. 50W A+ - E 12V

**Dimensions**

L340xB340xH130

L260xB260

**Materials**

aluminium 1 | 2 | 11 | 14 | 1M | 2M

**Ref**

620.AR70.45.1.1	white
620.AR70.45.1M.1M	white tex
620.AR70.45.2.7	black
620.AR70.45.2.40	black
620.AR70.45.2M.1M	black tex
620.AR70.45.11.40	alu grey
620.AR70.45.14.40	alu satin

built-up  
 with LED-transformer  
 mit LED-Trafo



911/.. - TITUS 230V

~230V IP20 0,5900 1 m 05.20.02 CE

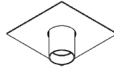

built-up ceiling light - fixed - with glass  
Aufbau Deckenleuchte - fest - mit Glas

Lamp type

1x QT14 G9 max. 33W A - E 230V

Dimensions

L125xB125xH90  
L90xB90xH30

Materials

aluminium 14 | 1M | 2M  
brass 13 | 16  
INOX 316 5

Ref

911.1M white tex  
911.2M black tex  
911.5 inox 316  
911.13 bronze  
911.14 alu satin  
911.16 satin gold

built-up

912/.. - TITUS 230V

~230V IP20 2,5600 1 m 05.20.02 CE

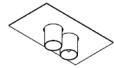

built-up ceiling light - fixed - with glass  
Aufbau Deckenleuchte - fest - mit Glas

Lamp type

2x QT14 G9 max. 33W A - E 230V

Dimensions

L300xB170xH85  
L225xB100xH25

Materials

aluminium 14 | 1M | 2M  
brass 13 | 16  
INOX 316 5

Ref

912.1M white tex  
912.2M black tex  
912.5 inox 316  
912.13 bronze  
912.14 alu satin  
912.16 satin gold

built-up

913/.. - TITUS 230V

~230V IP20 1,6250 1 m 05.20.02 CE

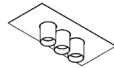

built-up ceiling light - fixed - with glass  
Aufbau Deckenleuchte - fest - mit Glas

Lamp type

3x QT14 G9 max. 33W A - E 230V

Dimensions

L370xB170xH85  
L290xB100xH25

Materials

aluminium 14 | 1M | 2M  
brass 13 | 16  
INOX 316 5

Ref

913.1M white tex  
913.2M black tex  
913.5 inox 316  
913.13 bronze  
913.14 alu satin  
913.16 satin gold

built-up

914/.. - TITUS 230V

~230V IP20 2,9000 1 m 05.20.02 CE



built-up ceiling light - fixed - with glass  
Aufbau Deckenleuchte - fest - mit Glas

Lamp type

4x QT14 G9 max. 33W A - E 230V

Dimensions

L300xB300xH85  
L220xB220xH25

Materials

aluminium 14 | 1M | 2M  
brass 13 | 16  
INOX 316 5

Ref

914.1M white tex  
914.2M black tex  
914.5 inox 316  
914.13 bronze  
914.14 alu satin  
914.16 satin gold

built-up

995/.. - TITUS Round

~230V  IP20      0,8140  1 m  05.20.02 



built-up ceiling light - fixed - with glass  
Aufbau Deckenleuchte - fest - mit Glas

Lamp type

1x QT14 G9 max. 33W  230V

Dimensions

Ø140xH90  
Ø100

Materials

aluminium 14 | 1M | 2M  
brass 13 | 16

Ref

995.1M	white tex
995.2M	black tex
995.13	bronze
995.14	alu satin
995.16	satin gold

built-up

996/.. - TITUS Round

~230V  IP20      1,4060  1 m  05.20.02 



built-up ceiling light - fixed - with glass  
Aufbau Deckenleuchte - fest - mit Glas

Lamp type

2x QT14 G9 max. 33W  230V

Dimensions

Ø200xH90  
Ø160

Materials

aluminium 14 | 1M | 2M  
brass 13 | 16

Ref

996.1M	white tex
996.2M	black tex
996.13	bronze
996.14	alu satin
996.16	satin gold

built-up

997/.. - TITUS Round

~230V  IP20      2,1610  1 m  05.20.02 



built-up ceiling light - fixed - with glass  
Aufbau Deckenleuchte - fest - mit Glas

Lamp type

3x QT14 G9 max. 33W  230V

Dimensions

Ø245xH90  
Ø190

Materials

aluminium 14 | 1M | 2M  
brass 13 | 16

Ref

997.1M	white tex
997.2M	black tex
997.13	bronze
997.14	alu satin
997.16	satin gold

built-up

998/.. - TITUS Round

~230V  IP20      2,8600  1 m  05.20.02 

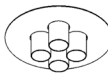

built-up ceiling light - fixed - with glass  
Aufbau Deckenleuchte - fest - mit Glas

Lamp type

4x QT14 G9 max. 33W  230V

Dimensions

Ø300xH90  
Ø220

Materials

aluminium 14 | 1M | 2M  
brass 13 | 16

Ref

998.1M	white tex
998.2M	black tex
998.13	bronze
998.14	alu satin
998.16	satin gold

built-up

1901/.. - TITUS SQ

~230V IP20 0,8300 1 m 05.20.02 CE



built-up ceiling light - fixed - with glass  
Aufbau Deckenleuchte - fest - mit Glas

Lamp type

1x QT14 G9 max. 33W A - E 230V

Dimensions

L130xB130xH90  
L110xB110xH30

Materials

aluminium 14 | 1M | 2M  
brass 13 | 16

Ref

1901.1M white tex  
1901.2M black tex  
1901.13 bronze  
1901.14 alu satin  
1901.16 satin gold

built-up

1902/.. - TITUS SQ

~230V IP20 1,9900 1 m 05.20.02 CE



built-up ceiling light - fixed - with glass  
Aufbau Deckenleuchte - fest - mit Glas

Lamp type

2x QT14 G9 max. 33W A - E 230V

Dimensions

L300xB170xH90  
L220xB100xH25

Materials

aluminium 14 | 1M | 2M  
brass 13 | 16

Ref

1902.1M white tex  
1902.2M black tex  
1902.13 bronze  
1902.14 alu satin  
1902.16 satin gold

built-up

1903/.. - TITUS SQ

~230V IP20 1,9700 1 m 05.20.02 CE

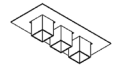

built-up ceiling light - fixed - with glass  
Aufbau Deckenleuchte - fest - mit Glas

Lamp type

3x QT14 G9 max. 33W A - E 230V

Dimensions

L390xB170xH90  
L310xB100xH25

Materials

aluminium 14 | 1M | 2M  
brass 13 | 16

Ref

1903.1M white tex  
1903.2M black tex  
1903.13 bronze  
1903.14 alu satin  
1903.16 satin gold

built-up

1904/.. - TITUS SQ

~230V IP20 2,6750 1 m 05.20.02 CE



built-up ceiling light - fixed - with glass  
Aufbau Deckenleuchte - fest - mit Glas

Lamp type

4x QT14 G9 max. 33W A - E 230V

Dimensions

L300xB300xH90  
L220xB220xH25

Materials

aluminium 14 | 1M | 2M  
brass 13 | 16

Ref

1904.1M white tex  
1904.2M black tex  
1904.13 bronze  
1904.14 alu satin  
1904.16 satin gold

built-up



973.ES50/.. - CALYPSO

~230V  IP20     1,7000  0,5 m  05.20.02 



built-up ceiling light - directional  
Aufbau Deckenleuchte - schwenkbar

**Lamp type**

 4x QPAR 51 GU10 max. 20W  -  230V

**Dimensions**

 L211xB211xH155

 L100xB100xH20

**Materials**

aluminium 14 | 1M | 2M

**Ref**

973.ES50.1M	white tex
973.ES50.2M	black tex
973.ES50.14	alu satin

built-up  
use coolfit lamp  
Coolfit-Lampe verwenden

1287.ES50/.. - PLAZA

~230V  IP20     0,4400  0,5 m  05.20.02 



built-up ceiling light - directional  
Aufbau Deckenleuchte - schwenkbar

**Lamp type**

 1x QPAR 51 GU10 max. 20W  -  230V

**Dimensions**

 Ø60xH200

 Ø56

**Materials**

aluminium 14 | 1M | 2M

**Ref**

1287.ES50.1M	white tex
1287.ES50.2M	black tex
1287.ES50.14	alu satin

built-up



954/.. - OPERA

~230V   IP20     1,0150  1 m  05.20.02 



built-up ceiling or wall light - directional - with transformer  
Decken- oder Wandleuchte für Aufbau - schwenkbar - mit Trafo

Lamp type

1x QR-LP111 G53 max. 50W  12V  
or 1x PAR 36 screw max. 50W  12V

Dimensions

L170xB177xH90  
L170xB40

Materials

aluminium 14 | 1M | 2M

Ref

954.1M white tex  
954.2M black tex  
954.14 alu satin

built-up  
with LED-transformer  
mit LED-Trafo

953/.. - OPERA

~230V   IP20     1,7050  1 m  05.20.02 



built-up ceiling or wall light - directional - with transformer  
Decken- oder Wandleuchte für Aufbau - schwenkbar - mit Trafo

Lamp type

2x QR-LP111 G53 max. 35W  12V  
or 2x PAR 36 screw max. 50W  12V

Dimensions

L310xB177xH90  
L310xB40

Materials

aluminium 14 | 1M | 2M

Ref

953.1M white tex  
953.2M black tex  
953.14 alu satin

built-up  
with LED-transformer  
mit LED-Trafo

955/.. - OPERA

~230V   IP20     2,4600  1 m  05.20.02 



built-up ceiling or wall light - directional - with transformer  
Decken- oder Wandleuchte für Aufbau - schwenkbar - mit Trafo

Lamp type

3x QR-LP111 G53 max. 35W  12V  
or 3x PAR 36 screw max. 50W  12V

Dimensions

L460xB177xH90  
L460xB40

Materials

aluminium 14 | 1M | 2M

Ref

955.1M white tex  
955.2M black tex  
955.14 alu satin

built-up  
with LED-transformer  
mit LED-Trafo

956/.. - OPERA

~230V   IP20     3,2000  1 m  05.20.02 



built-up ceiling or wall light - directional - with transformer  
Decken- oder Wandleuchte für Aufbau - schwenkbar - mit Trafo

Lamp type

4x QR-LP111 G53 max. 35W  12V  
or 4x PAR 36 screw max. 50W  12V

Dimensions

L605xB177xH90  
L605xB40

Materials

aluminium 14 | 1M | 2M

Ref

956.1M white tex  
956.2M black tex  
956.14 alu satin

built-up  
with LED-transformer  
mit LED-Trafo

1286/.. - LOBBY

~230V



built-up ceiling light - directional - with transformer  
Aufbau Deckenleuchte - schwenkbar - mit Trafo

Ref

1286.14

alu satin

Lamp type

1x QR-LP111 G53 max. 50W A - C 12V

Dimensions

Ø115xH275

Ø70xH8

Materials

aluminium

14

built-up  
tube Ø40 - with LED-transformer  
Rohr Ø40 - mit LED-Trafo

1412/.. - LOBBY

~230V



built-up ceiling light - directional - with transformer  
Aufbau Deckenleuchte - schwenkbar - mit Trafo

Ref

1412.2M

black tex

1412.14

alu satin

Lamp type

2x QR-LP111 G53 max. 30W A - C 12V

Dimensions

L300xB225xH410

Ø90xH8

Materials

aluminium

14 | 2M

built-up  
tube Ø40 - with LED-transformer  
Rohr Ø40 - mit LED-Trafo

1413/.. - LOBBY

~230V



built-up ceiling light - directional - with transformer  
Aufbau Deckenleuchte - schwenkbar - mit Trafo

Ref

1413.14

alu satin

Lamp type

3x QR-LP111 G53 max. 35W A - C 12V

Dimensions

L300xB300xH410

Ø90xH8

Materials

aluminium

14

built-up  
tube Ø40 - with LED-transformer  
Rohr Ø40 - mit LED-Trafo

1414/.. - LOBBY

~230V



built-up ceiling light - directional - with transformer  
Aufbau Deckenleuchte - schwenkbar - mit Trafo

Ref

1414.14

alu satin

Lamp type

4x QR-LP111 G53 max. 35W A - C 12V

Dimensions

L280xB280xH410

Ø90xH8

Materials

aluminium

14

built-up  
tube Ø40 - with LED-transformer  
Rohr Ø40 - mit LED-Trafo

1415LED/.. - LOBBY LED

~230V



IP20



built-up ceiling light - directional  
Aufbau Deckenleuchte - schwenkbar

Lamp type

1x 42LED # 2000lm CRI80 max. 16W **A+** 230V

Dimensions

L370xB370xH450

Ø90xH8

Materials

aluminium 14 | 1M | 2M

Ref

1415LED.1M.NW

white tex

1415LED.2M.NW

black tex

1415LED.14.NW

alu satin

built-up  
tube Ø40 - phase-cut  
Rohr Ø40 - Phasenabschnitt

1416LED/.. - LOBBY LED

~230V



IP20



built-up ceiling light - directional  
Aufbau Deckenleuchte - schwenkbar

Lamp type

2x led 1500lm max. 16W **A+** 230V

Dimensions

L730xB210xH440

Ø90xH8

Materials

aluminium 14 | 1M | 2M

Ref

1416LED.1M.NW

white tex

1416LED.2M.NW

black tex

1416LED.14.NW

alu satin

built-up  
tube Ø40 - phase-cut  
Rohr Ø40 - Phasenabschnitt





1450/.. - RETRO

~230V   IP20    1,7300  1 m  05.20.02 



built-up ceiling light - directional - with transformer  
 Aufbau Deckenleuchte - schwenkbar - mit Trafo

**Lamp type**  
 2x QR-LP111 G53 max. 20W  12V

**Dimensions**  
 L340xB145xH220  
 L80xB30

**Materials**  
 aluminium 10 | 1M | 2M

**Ref**  
 1450.1M white tex  
 1450.2M black tex  
 1450.10.2 alu grey

built-up  
 with LED-transformer  
 mit LED-Trafo

1451/.. - RETRO

~230V   IP20    2,9070  1 m  05.20.02 



built-up ceiling light - directional - with transformer  
 Aufbau Deckenleuchte - schwenkbar - mit Trafo

**Lamp type**  
 4x QR-LP111 G53 max. 20W  12V

**Dimensions**  
 L340xB290xH220  
 L180xB80

**Materials**  
 aluminium 10 | 1M | 2M

**Ref**  
 1451.1M white tex  
 1451.2M black tex  
 1451.10.2 alu grey

built-up  
 with Led-transformer  
 mit LED-Trafo



LUMINAIRES





1800/.. - BRIDGE PLAFOND

~230V   IP20    2,7800  1 m  05.20.02 



built-up ceiling light - directional - with transformer  
Aufbau Deckenleuchte - schwenkbar - mit Trafo

**Lamp type**  
2x QR-LP111 G53 max. 20W  -  12V

**Dimensions**  
L350xB190xH123  
L180xB40

**Materials**  
aluminium 1M | 2M | 11M







Ref	
1800.1M	white tex
1800.2M	black tex
1800.2M.7	black tex
1800.11M	grey tex

built-up  
with LED-transformer  
mit LED-Trafo



LUMINAIRES

3052.LED/.. - MAMBO

~230V   IP20    1 m  05.20.50 



built-up ceiling light - fixed - down  
Aufbau Deckenleuchte - fest - down

**Lamp type**  
2x Led 500lm CRI80 max. 4W  230V

**Dimensions**  
L220xB80xH105  
L220xB40xH50

**Materials**  
aluminium 14 | 1M | 2M | 11M

Ref	
3052.LED.1M.NW	white tex
3052.LED.2M.NW	black tex
3052.LED.11M.NW	grey tex
3052.LED.14.NW	alu satin

built-up  
do not screw on too tightly - Dimmable phase-cut  
nicht zu fest verschrauben - Phasenabschnitt





945.MT/.. - CAMERA UP

~230V   IP20     0,8900  0,5 m  05.20.02 





built-up ceiling light - directional - with transformer  
Aufbau Deckenleuchte - schwenkbar - mit Trafo

Lamp type

 1x QR-CB 51 GU5,3/GX5,3 max. 20W  -  12V

Dimensions

 L260xB107xH62  
 L230xB75

Materials

INOX / ALUMINIUM 14

Ref

945.MT.14.2 alu satin  
945.MT.14.11 alu satin

**built-up**  
with LED-transformer - socle black or grey - use coolfit lamp  
mit LED-Trafo - Sockel Schwarz oder Grau - Coolfit-Lampe verwenden

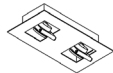

946.MT/.. - CAMERA UP

~230V   IP20     3,5200  0,5 m  05.20.02 





built-up ceiling light - directional - with transformer  
Aufbau Deckenleuchte - schwenkbar - mit Trafo

Lamp type

 2x QR-CB 51 GU5,3/GX5,3 max. 20W  -  12V

Dimensions

 L320xB170xH65  
 L250xB100

Materials

INOX / ALUMINIUM 14 | 2M

Ref

946.MT.2M.1M black tex  
946.MT.14.2 alu satin  
946.MT.14.11 alu satin

**built-up**  
with LED-transformer - socle black or grey - use coolfit lamp  
mit LED-Trafo - Sockel Schwarz oder Grau - Coolfit-Lampe verwenden



949/.. - CAMERA UP

~230V   IP20     3,2500  0,5 m  05.20.02 





built-up ceiling light - directional - with transformer  
Aufbau Deckenleuchte - schwenkbar - mit Trafo

Lamp type

 4x QR-CB 51 GU5,3/GX5,3 max. 20W  -  12V

Dimensions

 L320xB320xH65  
 L230xB230

Materials

INOX / ALUMINIUM 14 | 2M

Ref

949.2M.1M black tex  
949.14.2 alu satin  
949.14.11 alu satin

**built-up**  
with LED-transformer - socle black or grey - use coolfit lamp  
mit LED-Trafo - Sockel Schwarz oder Grau - Coolfit-Lampe verwenden



947/.. - CAMERA TWIN

~230V   IP20     1,0900  0,5 m  05.20.02 





built-up ceiling light - directional - with base 005 - with transformer  
Aufbau Deckenleuchte - schwenkbar - mit Rosette 005 - mit Trafo

Lamp type

 2x QR-CB 51 GU5,3/GX5,3 max. 20W  -  12V

Dimensions

 L210xB130xH60  
 Ø50

Materials

INOX / ALUMINIUM 14

Ref

947.14 alu satin

**built-up**  
with LED-transfo - use coolfit lamp  
mit LED-Trafo - Coolfit-Lampe verwenden

947B/.. - CAMERA TWIN

~230V   IP20    0,7400 0,5 m 05.20.02 



ceiling light for track - directional - without adaptor M10 - with transformer  
 Deckenleuchte für Schienensystem - schwenkbar - ohne Adapter M10 - mit Trafo

Ref  
 947B.14 alu satin

**Lamp type**  
 2x QR-CB 51 GU5,3/GX5,3 max. 20W  12V

**Dimensions**  
 L210xB130xH60

**Options**  
 T456.M10 - ADAPTOR

**Materials**  
 INOX / ALUMINIUM 14

*built-up  
 with LED-transfo - use coolfit lamp  
 mit LED-Trafo - Coolfit-Lampe verwenden*



LUMINAIRES

# INDOOR | Ceiling UP | Luminaires | MANTA

LED Farben: WW = 2800K - NW = 4000K - CW = 6500K

## W3143/.. - MANTA UP

~230V   IP65        



built-up ceiling light - round - fixed - with mat glass  
Aufbau Deckenleuchte - rund - fest - mit mattem Glas

### Lamp type

1x LED 380lm CRI80 max. 4W  230V

### Dimensions

Ø80xH54

### Options

S3147 - MANTA spare ring + glass

### Ref

W3143.1MA	CW   NW   WW
W3143.2MA	CW   NW   WW
W3143.11MA	CW   NW   WW
W3143.22A	CW   NW   WW

built-up  
blue (B) on request  
Blau (B) auf Anfrage

## W3142/.. - MANTA UP

=24V-DC    IP65        



built-up ceiling light - round - fixed - with mat glass - without transformer  
Aufbau Deckenleuchte - rund - fest - mit mattem Glas - ohne Trafo

### Lamp type

1x Led 24V-DC max. 3,6W  24V-DC

### Dimensions

Ø80xH54

### Options

S3147 - MANTA spare ring + glass

### Ref

W3142.1MA	CW   NW   WW
W3142.2MA	CW   NW   WW
W3142.11MA	CW   NW   WW
W3142.22A	CW   NW   WW

built-up  
blue (B) on request  
Blau (B) auf Anfrage



## W3141/.. - MANTA UP DOUCHE

~12V   IP65        



built-up ceiling light - round - fixed - with mat glass - without transformer  
Aufbau Deckenleuchte - rund - fest - mit mattem Glas - ohne Trafo

### Lamp type

1x QR-CB 51 GU5,3/GX5,3 max. 35W  -  12V

### Dimensions

Ø80xH92

### Options

S3148 - MANTA spare ring + glass

### Materials

ALU ANODISE 1MA | 22A | 2MA | 11MA

### Ref

W3141.1MA	white tex ano
W3141.2MA	black tex ano
W3141.11MA	grey tex ano
W3141.22A	matt gold ano

built-up  
20W-35W  
for showers  
für Duschen

## W3144/.. - MANTA UP

~230V  IP65        



built-up ceiling light - round - fixed - with mat glass  
Aufbau Deckenleuchte - rund - fest - mit mattem Glas

### Lamp type

1x QPAR 51 GU10 max. 20W  -  230V

### Dimensions

Ø80xH92

### Options

S3148 - MANTA spare ring + glass

### Materials

ALU ANODISE 1MA | 22A | 2MA | 11MA

### Ref

W3144.1MA	white tex ano
W3144.2MA	black tex ano
W3144.11MA	grey tex ano
W3144.22A	matt gold ano

built-up  
20W-35W





# INDOOR | Ceiling UP | Luminaires | MANTA

LED Farben: WW = 2800K - NW = 4000K - CW = 6500K

## W3145/.. - MANTA UP

~230V



built-up ceiling light - round - fixed - with mat glass  
Aufbau Deckenleuchte - rund - fest - mit mattem Glas

### Lamp type

1x QPAR 51 GU10 max. 20W **A+** - **E** **230V**

### Dimensions

Ø80xH117

### Options

S3148 - MANTA spare ring + glass

### Materials

ALU ANODISE 1MA | 22A | 2MA | 11MA

### Ref

W3145.1MA	white tex ano
W3145.2MA	black tex ano
W3145.11MA	grey tex ano
W3145.22A	mat gold ano

built-up

7W-9W-11W

## W3139/.. - MANTA UP

=24V-DC



built-up ceiling light - round - fixed - with mat high glass - without transformer  
Aufbau Deckenleuchte - rund - fest - mit mattem hohem Glas - ohne Trafo

### Lamp type

1x Led 24V-DC max. 3,6W **A+** **24V-DC**

### Dimensions

Ø80xH72

### Options

S3149 - MANTA spare ring + glass

### Ref

W3139.1MA	CW   NW   WW
W3139.2MA	CW   NW   WW
W3139.11MA	CW   NW   WW
W3139.22A	CW   NW   WW

built-up

blue (B) on request - glass H25  
Blau (B) auf Anfrage - Glas H25

## W3140/.. - MANTA UP DOUCHE

~12V



built-up ceiling light - round - fixed - with mat high glass - without transformer  
Aufbau Deckenleuchte - rund - fest - mit mattem hohem Glas - ohne Trafo

### Lamp type

1x QT12 GY6,35 max. 20W **B** - **C** **12V**

or 1x QR-CB 51 GU5,3/GX5,3 max. 20W **A+** - **E** **12V**

### Dimensions

Ø80xH92

### Options

S3150 - MANTA spare ring + glass

### Materials

ALU ANODISE 1MA | 22A | 2MA | 11MA

### Ref

W3140.1MA	white tex ano
W3140.2MA	black tex ano
W3140.11MA	grey tex ano
W3140.22A	mat gold ano

built-up

Glas H45mm  
for showers  
für Duschen

## W3146/.. - MANTA UP

~230V



built-up ceiling light - round - fixed - with mat high glass  
Aufbau Deckenleuchte - rund - fest - mit mattem hohem Glas

### Lamp type

1x TC-SEI E27 max. 12W **A** - **B** **230V**

### Dimensions

Ø80xH137

### Options

S3151 - MANTA spare ring + glass

### Materials

ALU ANODISE 1MA | 22A | 2MA | 11MA

### Ref

W3146.1MA	white tex ano
W3146.2MA	black tex ano
W3146.11MA	grey tex ano
W3146.22A	mat gold ano

built-up

Glas H65





642.250.LED/.. - MONET ROND

~230V      1,4900  0,5 m  



built-up

built-up ceiling light - polycarbonate - with LED driver  
Aufbau Deckenleuchte - Polykarbonat - mit Driver LED

<b>Lamp type</b>	1x Led 1600lm CRI80 max. 16W 	230V
<b>Dimensions</b>	↔ Ø254xH65 ⚙ Ø254	
<b>Materials</b>	aluminium 14   1M   2M   11M brass 7   13   16   23 red copper 28	

<b>Ref</b>	
642.250.LED.1M.NW	white tex
642.250.LED.2M.NW	black tex
642.250.LED.7.NW	chrome
642.250.LED.11M.NW	grey tex
642.250.LED.13.NW	bronze
642.250.LED.14.NW	alu satin
642.250.LED.16.NW	satin gold
642.250.LED.23.NW	dark bronze
642.250.LED.28.NW	rosé
642.250.LED.28.WW	rosé

642.350.LED/.. - MONET ROND

~230V      2,9850  0,5 m  



built-up

built-up ceiling light - polycarbonate  
Aufbau Deckenleuchte - Polykarbonat

<b>Lamp type</b>	1x LED 2300lm CRI80 max. 24W 	230V
<b>Dimensions</b>	↔ Ø340xH65 ⚙ Ø340	
<b>Materials</b>	aluminium 14   1M   2M   11M brass 7   13   16   23 red copper 28	

<b>Ref</b>	
642.350.LED.1M.NW	white tex
642.350.LED.2M.NW	black tex
642.350.LED.7.NW	chrome
642.350.LED.11M.NW	grey tex
642.350.LED.13.NW	bronze
642.350.LED.14.NW	alu satin
642.350.LED.16.NW	satin gold
642.350.LED.23.NW	dark bronze
642.350.LED.28.NW	rosé
642.350.LED.28.WW	rosé

541.SEN/.. - MONET ROND LED

~230V      0,5 m  



built-up

built-up ceiling light - polycarbonate - with built-in sensor - with LED driver  
Aufbau Deckenleuchte - Polykarbonat - mit eingebautem Sensor - mit Driver LED

<b>Lamp type</b>	1x Led 3900lm CRI80 max. 34,1W 	1050mA
<b>Dimensions</b>	↔ Ø360xH80 ⚙ Ø360	
<b>Materials</b>	aluminium 14   1M   2M	

<b>Ref</b>	
541.SEN.1M.NW	white tex
541.SEN.2M.NW	black tex
541.SEN.14.NW	alu satin

3063/.. - TOLEDO

~230V



built-up ceiling or wall light - round  
Decken- oder Wandleuchte für Aufbau - rund

Lamp type

1x TCR-TSE GX53 max. 5W A+ - E 230V

Dimensions

Ø82,5xH27

Materials

aluminium 1 | 11 | 14

Ref

3063.1	white
3063.11	alu grey
3063.14	alu satin

built-up

3063.ZA/.. - TOLEDO

~230V

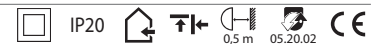

built-up ceiling or wall light - round - sidelong cable connection  
Decken- oder Wandleuchte für Aufbau - rund - lateraler Kabelanschluß

Lamp type

1x TCR-TSE GX53 max. 5W A+ - E 230V

Dimensions

Ø82,5xH27

Materials

aluminium 14 | 1M | 2M

Ref

3063.ZA.1M	white tex
3063.ZA.2M	black tex
3063.ZA.14	alu satin

built-up

3064/.. - TOLEDO

~230V

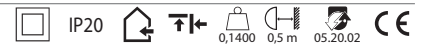

built-up ceiling or wall light - round  
Decken- oder Wandleuchte für Aufbau - rund

Lamp type

1x TCR-TSE GX53 max. 5W A+ - E 230V

Dimensions

Ø83xH32

Materials

aluminium 14

Ref

3064.14	alu satin
---------	-----------

built-up

W3064/.. - TOLEDO

~230V

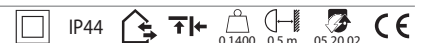

built-up ceiling or wall light - round  
Decken- oder Wandleuchte für Aufbau - rund

Lamp type

1x TCR-TSE GX53 max. 5W A+ - E 230V

Dimensions

Ø83xH32

Materials

ALU ANODISE 36A

Ref

W3064.36A	alu grey ano
-----------	--------------

built-up



3061W/.. - TOLEDO

~230V



built-up ceiling or wall light - round - fixed  
Decken- oder Wandleuchte für Aufbau - rund - fest

Lamp type

1x TCR-TSE GX53 max. 5W A+ - E 230V

Dimensions

Ø100xH45

Materials

aluminium 14 | 1M | 2M | 37A

Ref

3061W.1M	white tex
3061W.2M	black tex
3061W.14	alu satin
3061W.37A	grey text ano

built-up

W3061W/.. - TOLEDO

~230V



built-up ceiling or wall light - round - fixed  
Decken- oder Wandleuchte für Aufbau - rund - fest

Lamp type

1x TCR-TSE GX53 max. 5W A+ - E 230V

Dimensions

Ø100xH45

Options

2320.230V - A: LED CASSETTE 230V 3,6W IP65

Materials

ALU ANODISE 32A | 37A

Ref

W3061W.32A	black texture ano
W3061W.37A	grey text ano

built-up

3065A/.. - TOLEDO

~230V



built-up ceiling or wall light - round - fixed  
Decken- oder Wandleuchte für Aufbau - rund - fest

Lamp type

1x TCR-TSE GX53 max. 5W A+ - E 230V

Dimensions

Ø89,5xH42

Materials

aluminium 14 | 2M

Ref

3065A.2M	black tex
3065A.14	alu satin

built-up

W3065A/.. - TOLEDO

~230V



built-up ceiling or wall light - round - fixed  
Decken- oder Wandleuchte für Aufbau - rund - fest

Lamp type

1x TCR-TSE GX53 max. 5W A+ - E 230V

Dimensions

Ø89,5xH42

Materials

ALU ANODISE 32A | 37A | 33MA

Ref

W3065A.32A	black texture ano
W3065A.33MA	textured brown ano
W3065A.37A	grey text ano

built-up

3065B/.. - TOLEDO

~230V IP20 0,3000 0,5 m 05.20.02 CE



built-up ceiling or wall light - round - fixed  
Decken- oder Wandleuchte für Aufbau - rund - fest

**Lamp type**  
1x TCR-TSE GX53 max. 5W **A+** - **E** 230V

**Dimensions**  
Ø89,5xH62

**Materials**  
aluminium 14 | 1M | 2M

**Ref**  
3065B.1M white tex  
3065B.2M black tex  
3065B.14 alu satin

built-up

W3065B/.. - TOLEDO

~230V IP44 0,3000 0,5 m 05.20.02 CE



built-up ceiling or wall light - round - fixed  
Decken- oder Wandleuchte für Aufbau - rund - fest

**Lamp type**  
1x TCR-TSE GX53 max. 5W **A+** - **E** 230V

**Dimensions**  
Ø89,5xH62

**Options**  
2320.230V - A: LED CASSETTE 230V 3,6W IP65

**Materials**  
ALU ANODISE 32A | 37A

**Ref**  
W3065B.32A black texture ano  
W3065B.37A grey text ano

built-up

3062W/.. - TOLEDO

~230V IP20 0,4650 0,5 m 05.20.02 CE



built-up ceiling or wall light - square - fixed  
Decken- oder Wandleuchte für Aufbau - viereckig - fest

**Lamp type**  
1x TCR-TSE GX53 max. 5W **A+** - **E** 230V

**Dimensions**  
L100xB100xH45

**Materials**  
aluminium 14

**Ref**  
3062W.14 alu satin

built-up

W3062W/.. - TOLEDO

~230V IP44 0,4650 0,5 m 05.20.02 CE



built-up ceiling or wall light - square - fixed  
Decken- oder Wandleuchte für Aufbau - viereckig - fest

**Lamp type**  
1x TCR-TSE GX53 max. 5W **A+** - **E** 230V

**Dimensions**  
L100xB100xH45

**Options**  
2320.230V - A: LED CASSETTE 230V 3,6W IP65

**Materials**  
ALU ANODISE 32A | 37A

**Ref**  
W3062W.32A black texture ano  
W3062W.37A grey text ano

built-up

3069/.. - TOLEDO

~230V



IP20



0,4330 0,5 m 05.20.02



built-up ceiling or wall light - square - fixed  
Decken- oder Wandleuchte für Aufbau - viereckig - fest

**Lamp type**

1x TCR-TSE GX53 max. 5W **A+** - **E** **230V**

**Dimensions**

L100xB100xH45

**Materials**

ALU ANODISE **32A**  
aluminium **1 | 2 | 14 | 1M | 2M**

**Ref**

3069.1	white
3069.1M	white tex
3069.2	black
3069.2M	black tex
3069.14	alu satin

built-up

LUMINAIRES



**W3069/.. - TOLEDO**

~230V IP44 0,4550 0,5 m 05.20.02 CE



built-up ceiling or wall light - square - fixed  
Decken- oder Wandleuchte für Aufbau - viereckig - fest

**Lamp type**  
1x TCR-TSE GX53 max. 5W A+ - E 230V

**Dimensions**  
L100xB100xH47

**Options**  
2320.230V - A: LED CASSETTE 230V 3,6W IP65

**Materials**  
ALU ANODISE 32A | 37A | 46A

**Ref**  
W3069.32A  
W3069.37A  
W3069.46A  
black texture ano  
grey text ano  
grey-brown ano

built-up

**3079/.. - TOLEDO**

~230V IP20 0,5200 0,5 m 05.20.02 CE

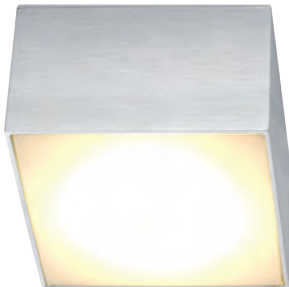

built-up ceiling or wall light - square - fixed  
Decken- oder Wandleuchte für Aufbau - viereckig - fest

**Lamp type**  
1x TCR-TSE GX53 max. 5W A+ - E 230V

**Dimensions**  
L100xB100xH70

**Materials**  
aluminium 1 | 14

**Ref**  
3079.1  
3079.14  
white  
alu satin

built-up

**W3079/.. - TOLEDO**

~230V IP44 0,5450 0,5 m 05.20.02 CE



built-up ceiling or wall light - square - fixed  
Decken- oder Wandleuchte für Aufbau - viereckig - fest

**Lamp type**  
1x TCR-TSE GX53 max. 5W A+ - E 230V

**Dimensions**  
L100xB100xH70

**Options**  
2320.230V - A: LED CASSETTE 230V 3,6W IP65

**Materials**  
ALU ANODISE 32A | 37A | 46A

**Ref**  
W3079.32A  
W3079.37A  
W3079.46A  
black texture ano  
grey text ano  
grey-brown ano

built-up

**3076B/.. - TOLEDO**

~230V IP20 3,0000 0,5 m 05.20.02 CE



built-up wall light - stainless steel fixation on top!  
Wandleuchte für Aufbau - Befestigung in Edelstahl oben!

**Lamp type**  
1x TCR-TSE GX53 max. 5W A+ - E 230V

**Dimensions**  
B90xH27xD125  
L125xB90

**Materials**  
aluminium 1M | 2M  
INOX 316 5

**Ref**  
3076B.1M  
3076B.2M  
3076B.5  
white tex  
black tex  
inox 316

built-up  
for application in kitchen and bathroom closets  
für Anwendung in Badezimmer- & Küchenschranken

640.200.LED/.. - MONET CARRE LED

~230V  IP20    1,7000  0,5 m  



ceiling light - stainless steel housing + polycarbonate cover  
Deckenleuchte - Gehäuse in Edelstahl + Deckel in Polykarbonat

Lamp type

1x 21LED # 1000lm CRI80 max. 8W  230V

Dimensions

L205xB205xH60

Materials

INOX 5 | 1M | 2M





Ref

640.200.LED.1M.NW white tex  
640.200.LED.2M.NW black tex  
640.200.LED.5.NW inox 316

built-up

Dimmable phase-cut  
Phasenabschnitt

640.300.LED/.. - MONET CARRE LED

~230V  IP20    0,5 m  

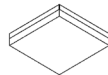

ceiling light - stainless steel housing + poly carbonate cover - LED  
Deckenleuchte - Edelstahl Gehäuse + Deckel in Polykarbonat - LED

Lamp type

1x Led 3000lm CRI80 max. 24W  230V

Dimensions

L305xB305xH60

Materials

INOX 5 | 1M | 2M

Ref

640.300.LED.1M.NW white tex  
640.300.LED.2M.NW black tex  
640.300.LED.5.NW inox 316

built-up

Dimmable phase-cut - not available in WW  
Phasenabschnitt - nicht verfügbar in WW

640.400.LED/.. - MONET CARRE LED

~230V  IP20    0,5 m  

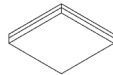

ceiling light - stainless steel housing + polycarbonate cover - with LED driver  
Deckenleuchte - Gehäuse in Edelstahl + Deckel in Polykarbonat - mit Driver LED

Lamp type

1x Led 2400lm CRI80 max. 17W 230V

Dimensions

L405xB405xH60

Materials

INOX 5 | 1M | 2M

Ref

640.400.LED.1M.NW white tex  
640.400.LED.2M.NW black tex  
640.400.LED.5.NW inox 316

built-up

Dimmable phase-cut  
Phasenabschnitt



641.SL335.LED/.. - MONET STRIP LED

~230V



IP44



1,0300

0,5 m

05.20.50

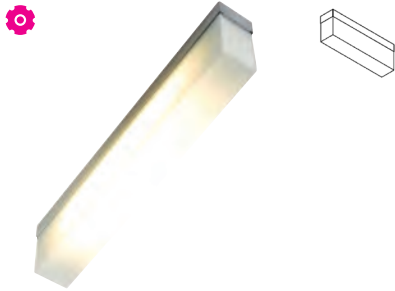

built-up ceiling or wall light - stainless steel housing + polycarbonate cover  
Decken- oder Wandleuchte für Aufbau - Gehäuse in Edelstahl + Deckel in Polykarbonat

Lamp type

1x led 1500lm max. 16W A+ 230V

Dimensions

L335xB55xH95

Materials

INOX 5 | 1M | 2M

Ref

- 641.SL335.LED.1M.NW white tex
- 641.SL335.LED.1M.WW white tex
- 641.SL335.LED.2M.NW black tex
- 641.SL335.LED.2M.WW black tex
- 641.SL335.LED.5.NW inox 316
- 641.SL335.LED.5.WW inox 316

built-up  
Dimmable phase-cut  
Phasenabschnitt

641.SL600.LED/.. - MONET STRIP LED

~230V



IP44



0,5 m

05.20.50

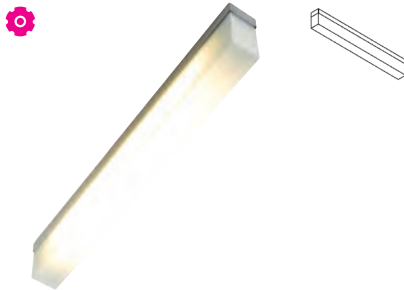

built-up ceiling or wall light - stainless steel housing + polycarbonate cover  
Decken- oder Wandleuchte für Aufbau - Gehäuse in Edelstahl + Deckel in Polykarbonat

Lamp type

1x led 1500lm max. 16W A+ 230V

Dimensions

L605xB55xH95

Materials

INOX 5 | 1M | 2M

Ref

- 641.SL600.LED.1M.NW white tex
- 641.SL600.LED.1M.WW white tex
- 641.SL600.LED.2M.NW black tex
- 641.SL600.LED.2M.WW black tex
- 641.SL600.LED.5.NW inox 316
- 641.SL600.LED.5.WW inox 316

built-up  
Dimmable phase-cut  
Phasenabschnitt



# INDOOR | Ceiling UP | Luminaires | FLOU SQ

Current values CITYLED 815lm 9,2W 230V. New Values from Q3/2017 NB. CITIZEN LED 230V 1000lm CRI90

Aktuelle Werte CITYLED 815lm 9,2W 230V. Neue Werte Q3 / 2017 NB. CITIZEN LED 230V 1000 lm CRI90

5226/.. - FLOU

~230V



IP20



1,0700

0,5 m

05.20.50



built-up ceiling light - square - fixed - down - with led  
Aufbau Deckenleuchte - viereckig - fest - down - mit Led

### Lamp type

1x LED 850lm CRI90 max. 10W 230V

### Dimensions

L100xB100xH130 30° reflector

### Ref

5226.1M	NW   WW
5226.2M.1M	NW   WW
5226.2M	NW   WW
5226.14	NW   WW
5226.45.45	NW   WW

built-up

LUMINAIRES

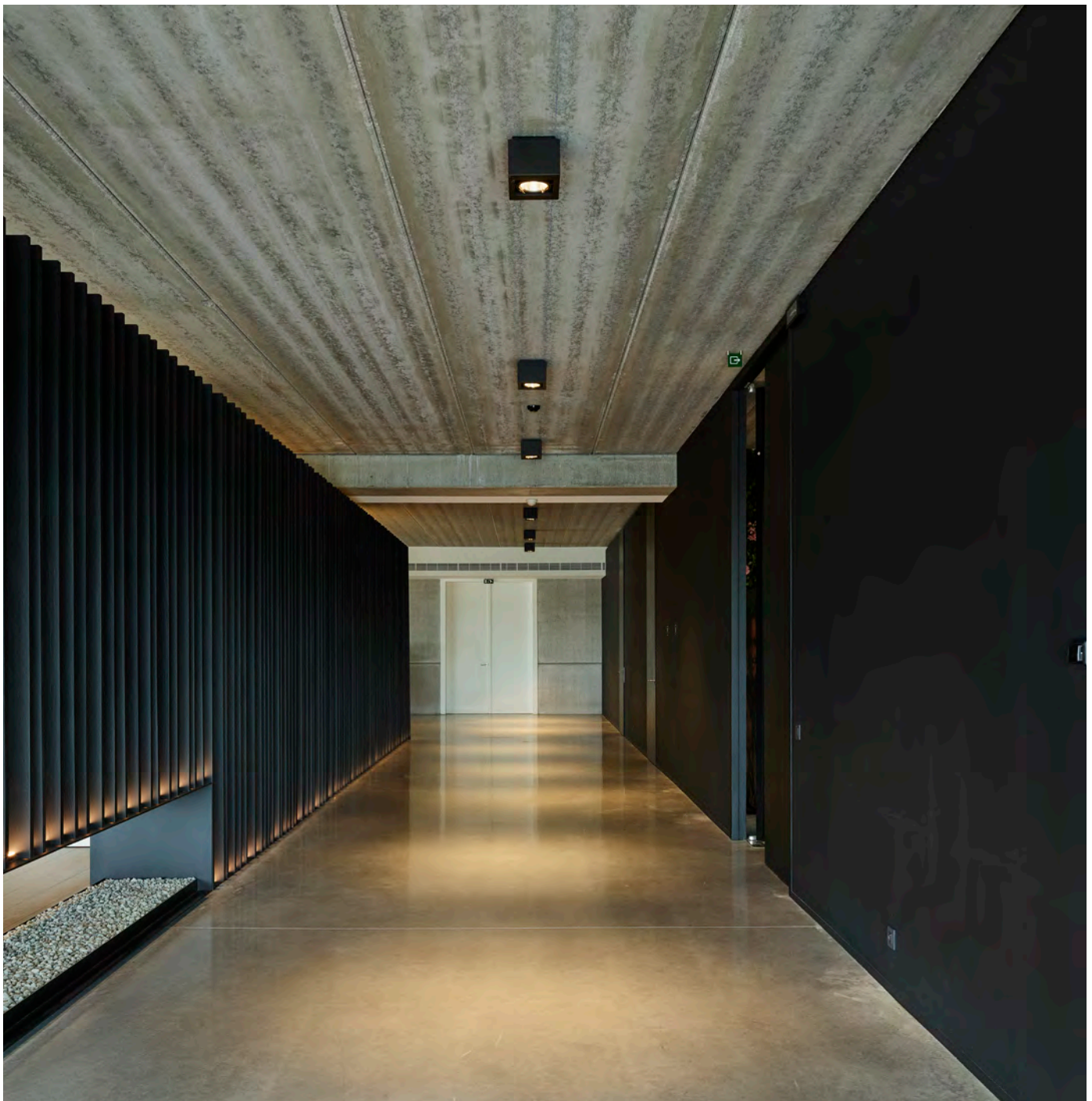

1701.ES50/.. - BETAPLUS

~230V



built-up ceiling light - fixed - down  
Aufbau Deckenleuchte - fest - down

Lamp type

1x QPAR 51 GU10 max. 20W A+ - E **230V**

Dimensions

L90xB90xH110

Materials

aluminium 14 | 1M | 29 | 2M | 47 | 49 | 77 | 11M

Ref

1701.ES50.1M	white tex
1701.ES50.2M	black tex
1701.ES50.11M	grey tex
1701.ES50.14.11.5	alu satin
1701.ES50.29	black - gold inside
1701.ES50.47	black - white inside
1701.ES50.77	white - black inside
1701.ES50.49	white - gold inside

built-up

1702.ES50/.. - BETAPLUS

~230V

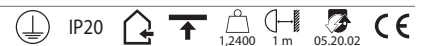

built-up ceiling light - fixed - down  
Aufbau Deckenleuchte - fest - down

Lamp type

2x QPAR 51 GU10 max. 20W A+ - E **230V**

Dimensions

L162xB90xH110

Materials

aluminium 14 | 1M | 29 | 2M | 47 | 49 | 77 | 11M

Ref

1702.ES50.1M	white tex
1702.ES50.2M	black tex
1702.ES50.2M.1M	black tex
1702.ES50.11M	grey tex
1702.ES50.14.11.5	alu satin
1702.ES50.29	black - gold inside
1702.ES50.47	black - white inside
1702.ES50.77	white - black inside
1702.ES50.49	white - gold inside

built-up

1703.ES50/.. - BETAPLUS

~230V



built-up ceiling light - fixed - down  
Aufbau Deckenleuchte - fest - down

Lamp type

3x QPAR 51 GU10 max. 20W A+ - E **230V**

Dimensions

L232xB90xH110

Materials

aluminium 1M | 29 | 2M | 47 | 49 | 77 | 11M

Ref

1703.ES50.1M	white tex
1703.ES50.2M	black tex
1703.ES50.11M	grey tex
1703.ES50.29	black - gold inside
1703.ES50.47	black - white inside
1703.ES50.77	white - black inside
1703.ES50.49	white - gold inside

built-up

1705.ES50/.. - BETAPLUS

~230V  IP20    0,8800 1 m 05.20.02 



built-up ceiling light - directional - down  
Aufbau Deckenleuchte - schwenkbar - down

**Lamp type**  
1x QPAR 51 GU10 max. 20W  -  **230V**

**Dimensions**  
L90xB90xH110

**Materials**  
aluminium 14 | 1M | 29 | 2M | 47 | 49 | 77 | 11M

Ref	
1705.ES50.1M	white tex
1705.ES50.2M	black tex
1705.ES50.11M	grey tex
1705.ES50.14.11	alu satin
1705.ES50.29	black - gold inside
1705.ES50.47	black - white inside
1705.ES50.77	white - black inside
1705.ES50.49	white - gold inside

built-up

1706.ES50/.. - BETAPLUS

~230V  IP20    1,2850 1 m 05.20.02 



built-up ceiling light - directional - down  
Aufbau Deckenleuchte - schwenkbar - down

**Lamp type**  
2x QPAR 51 GU10 max. 20W  -  **230V**

**Dimensions**  
L162xB90xH110

**Materials**  
aluminium 14 | 1M | 29 | 2M | 47 | 49 | 77 | 11M

Ref	
1706.ES50.1M	white tex
1706.ES50.2M	black tex
1706.ES50.11M	grey tex
1706.ES50.14.11	alu satin
1706.ES50.29	black - gold inside
1706.ES50.47	black - white inside
1706.ES50.77	white - black inside
1706.ES50.49	white - gold inside

built-up

1707.ES50/.. - BETAPLUS

~230V  IP20    1,7500 1 m 05.20.02 



built-up ceiling light - directional - down  
Aufbau Deckenleuchte - schwenkbar - down

**Lamp type**  
3x QPAR 51 GU10 max. 20W  -  **230V**

**Dimensions**  
L232xB90xH110

**Materials**  
aluminium 1M | 29 | 2M | 47 | 49 | 77 | 11M

Ref	
1707.ES50.1M	white tex
1707.ES50.2M	black tex
1707.ES50.11M	grey tex
1707.ES50.29	black - gold inside
1707.ES50.47	black - white inside
1707.ES50.77	white - black inside
1707.ES50.49	white - gold inside

built-up



1711.ES50/.. - BETAPLUS

~230V IP44 0,9650 1 m 05.20.02 CE



built-up ceiling light - down - with glass  
Aufbau Deckenleuchte - down - mit Glas

Lamp type

1x QPAR 51 GU10 max. 20W A+ - E 230V

Dimensions

L90xB90xH110

Materials

aluminium 14 | 1M | 29 | 2M | 11M

Ref

1711.ES50.1M	white tex
1711.ES50.2M	black tex
1711.ES50.11M	grey tex
1711.ES50.14.11.5	alu satin
1711.ES50.29	black - gold inside

built-up

1712.ES50/.. - BETAPLUS

~230V IP20 1,3700 1 m 05.20.02 CE



built-up ceiling light - down - with glass  
Aufbau Deckenleuchte - down - mit Glas

Lamp type

2x QPAR 51 GU10 max. 20W A+ - E 230V

Dimensions

L162xB90xH110

Materials

aluminium 14 | 1M | 29 | 2M | 11M

Ref

1712.ES50.1M	white tex
1712.ES50.2M	black tex
1712.ES50.11M	grey tex
1712.ES50.14.11.5	alu satin
1712.ES50.29	black - gold inside

built-up

1713.ES50/.. - BETAPLUS

~230V IP20 2,6500 1 m 05.20.02 CE



built-up ceiling light - down - with glass  
Aufbau Deckenleuchte - down - mit Glas

Lamp type

3x QPAR 51 GU10 max. 20W A+ - E 230V

Dimensions

L232xB90xH110

Materials

aluminium 1M | 29 | 2M | 11M

Ref

1713.ES50.1M	white tex
1713.ES50.2M	black tex
1713.ES50.11M	grey tex
1713.ES50.29	black - gold inside

built-up



1885DS.ES50/.. - SPINNER X DS

~230V  IP20    1,1400  1 m  05.20.02  CE



built-up ceiling light - directional - down  
Aufbau Deckenleuchte - schwenkbar - down

**Lamp type**  
1x QPAR 51 GU10 max. 20W  -  **230V**

**Dimensions**  
L100xB100xH130

**Materials**  
aluminium **2 | 1M | 2M | 11M**

Ref	
1885DS.ES50.1M	white tex
1885DS.ES50.2	black
1885DS.ES50.2M	black tex
1885DS.ES50.2M.2.14	black tex
1885DS.ES50.11M.11M.14	grey tex

built-up

1886DS.ES50/.. - SPINNER X DS

~230V  IP20    1,7000  1 m  05.20.02  CE

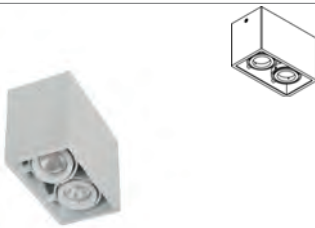

built-up ceiling light - directional - down  
Aufbau Deckenleuchte - schwenkbar - down

**Lamp type**  
2x QPAR 51 GU10 max. 20W  -  **230V**

**Dimensions**  
L182xB100xH130

**Materials**  
aluminium **2 | 1M | 2M | 11M**

Ref	
1886DS.ES50.1M	white tex
1886DS.ES50.2	black
1886DS.ES50.2M.2.14	black tex
1886DS.ES50.2M.2M	black tex
1886DS.ES50.11M.2.14	grey tex

built-up

1887DS.ES50/.. - SPINNER X DS

~230V  IP20    2,3000  1 m  05.20.02  CE



built-up ceiling light - directional - down  
Aufbau Deckenleuchte - schwenkbar - down

**Lamp type**  
3x QPAR 51 GU10 max. 20W  -  **230V**

**Dimensions**  
L266xB100xH130

**Materials**  
aluminium **2 | 1M | 2M | 11M**

Ref	
1887DS.ES50.1M	white tex
1887DS.ES50.2	black
1887DS.ES50.2M.2.14	black tex
1887DS.ES50.2M.2M	black tex
1887DS.ES50.11M.2.14	grey tex

built-up



1888DS.ES50/.. - SPINNER X DS

~230V  IP20    2,7400  1 m  05.20.02 



built-up ceiling light - directional - down  
Aufbau Deckenleuchte - schwenkbar - down

Lamp type

 4x QPAR 51 GU10 max. 20W  -  230V

Dimensions

 L350xB100xH130

Materials

aluminium 1M | 2M | 11M

Ref

1888DS.ES50.1M white tex  
1888DS.ES50.2M.2.14 black tex  
1888DS.ES50.11M.2.14 grey tex  
1888DS.ES50.11M.11M.14 grey tex

built-up



1890DS.ES50/.. - SPINNER X DS

~230V  IP20    3,3700  0,5 m  05.20.02 



built-up ceiling light - directional - down  
Aufbau Deckenleuchte - schwenkbar - down

Lamp type

 4x QPAR 51 GU10 max. 20W  -  230V

Dimensions

 L198xB198xH130

Materials

aluminium 2 | 1M | 2M | 11M

Ref

1890DS.ES50.1M.1M white tex  
1890DS.ES50.2 black  
1890DS.ES50.2M.2.14 black tex  
1890DS.ES50.2M.2M black tex  
1890DS.ES50.11M.2.14 grey tex  
1890DS.ES50.11M.11M.14 grey tex

built-up



1885.ES50/.. - SPINNER X FORUM

~230V



IP20



built-up ceiling light - square - directional - down  
 Aufbau Deckenleuchte - viereckig - schwenkbar - down

Lamp type

1x QPAR 51 GU10 max. 20W A+ - E 230V

Dimensions

L100xB100xH130

Options

1850 - SPINNER X DOWNRING

Materials

aluminium 1M | 2M | 11M

Ref

1885.ES50.1M	white tex
1885.ES50.2M.2	black tex
1885.ES50.2M.2.14	black tex
1885.ES50.11M.2.14	grey tex

built-up

1886.ES50/.. - SPINNER X FORUM

~230V



IP20



built-up ceiling light - directional - down  
 Aufbau Deckenleuchte - schwenkbar - down

Lamp type

2x QPAR 51 GU10 max. 20W A+ - E 230V

Dimensions

L182xB100xH130

Options

1850 - SPINNER X DOWNRING

Materials

aluminium 1M | 2M | 11M

Ref

1886.ES50.1M	white tex
1886.ES50.2M.2	black tex
1886.ES50.2M.2.14	black tex
1886.ES50.11M.2.14	grey tex

built-up

1887.ES50/.. - SPINNER X FORUM

~230V



IP20



built-up ceiling light - directional - down  
 Aufbau Deckenleuchte - schwenkbar - down

Lamp type

3x QPAR 51 GU10 max. 20W A+ - E 230V

Dimensions

L266xB100xH130

Options

1850 - SPINNER X DOWNRING

Materials

aluminium 1M | 2M | 11M

Ref

1887.ES50.1M	white tex
1887.ES50.2M.2.14	black tex
1887.ES50.11M.2.14	grey tex

built-up

1888.ES50/.. - SPINNER X FORUM

~230V



IP20



built-up ceiling light - directional - down  
 Aufbau Deckenleuchte - schwenkbar - down

Lamp type

4x QPAR 51 GU10 max. 20W A+ - E 230V

Dimensions

L350xB100xH130

Options

1850 - SPINNER X DOWNRING

Materials

aluminium 1M | 2M | 11M

Ref

1888.ES50.1M	white tex
1888.ES50.2M.2.14	black tex
1888.ES50.11M.2.14	grey tex

built-up

1890.ES50/.. - SPINNER X FORUM

~230V



IP20



built-up ceiling light - directional - down  
 Aufbau Deckenleuchte - schwenkbar - down

**Lamp type**

4x QPAR 51 GU10 max. 20W A+ - E 230V

**Dimensions**

L198xB198xH130

**Options**

1850 - SPINNER X DOWNRING

**Materials**

aluminium 1M | 2M | 11M

**Ref**

1890.ES50.1M	white tex
1890.ES50.2M.2.14	black tex
1890.ES50.11M.2.14	grey tex

built-up





1875/.. - SPINNER X AR70

~230V   IP20    2,0400  1 m  05.20.02 



built-up ceiling light - directional - down - with transformer  
Aufbau Deckenleuchte - schwenkbar - down - mit Trafo

**Lamp type**  
1x QR-LP70 BA15d max. 50W  -  12V

**Dimensions**  
L149xB149xH130

**Materials**  
aluminium 1M | 2M | 11M

Ref	
1875.1M.1M	white tex
1875.2M.2.14	black tex
1875.2M.2M	black tex
1875.11M.2.14	grey tex

built-up  
with LED-transformer - chrome on request  
mit LED-Trafo - Chrom auf Anfrage

1876/.. - SPINNER X AR70

~230V   IP20    2,3850  1 m  05.20.02 



built-up ceiling light - directional - down - with transformer  
Aufbau Deckenleuchte - schwenkbar - down - mit Trafo

**Lamp type**  
2x QR-LP70 BA15d max. 20W  -  12V

**Dimensions**  
L252xB149xH130

**Materials**  
aluminium 1M | 2M | 11M

Ref	
1876.1M.1M	white tex
1876.2M.2.14	black tex
1876.2M.2M	black tex
1876.2M.45	black tex
1876.11M.2.14	grey tex

built-up  
with LED-transformer - chrome on request  
mit LED-Trafo - Chrom auf Anfrage

1877/.. - SPINNER X AR70

~230V   IP20    3,8100  1 m  05.20.02 



built-up ceiling light - directional - down - with transformer  
Aufbau Deckenleuchte - schwenkbar - down - mit Trafo

**Lamp type**  
3x QR-LP70 BA15d max. 20W  -  12V

**Dimensions**  
L356xB149xH130

**Materials**  
aluminium 1M | 2M | 11M

Ref	
1877.1M.1M	white tex
1877.2M.2	black tex
1877.2M.2.14	black tex
1877.11M.2.14	grey tex

built-up  
with LED-transformer - chrome on request  
mit LED-Trafo - 2x105VA - Chrom auf Anfrage

1878/.. - SPINNER X AR70

~230V   IP20    5,0750  1 m  05.20.02 



built-up ceiling light - directional - down - with transformer  
Aufbau Deckenleuchte - schwenkbar - down - mit Trafo

**Lamp type**  
4x QR-LP70 BA15d max. 20W  -  12V

**Dimensions**  
L460xB149xH130

**Materials**  
aluminium 1M | 2M | 11M

Ref	
1878.1M.1M	white tex
1878.2M.2.14	black tex
1878.2M.2M	black tex
1878.11M.2.14	grey tex

built-up  
with LED-transformer - chrome on request  
mit LED-Trafo - Chrom auf Anfrage





1880../.. - SPINNER X AR70

~230V   IP20    5,1850  0,5 m  05.20.02 



built-up ceiling light - directional - down - with transformer  
Aufbau Deckenleuchte - schwenkbar - down - mit Trafo

**Lamp type**  
4x QR-LP70 BA15d max. 20W  -  12V

**Dimensions**  
L262xB262xH130

**Materials**  
aluminium 1M | 2M | 11M

Ref	
1880.1M.1M	white tex
1880.2M.2.14	black tex
1880.2M.2.2M	black tex
1880.11M.2.14	grey tex

built-up  
with LED-transformer - chrome on request  
mit LED-Trafo - Chrom auf Anfrage

1875.GU10../.. - SPINNER X AR70 GU10

~230V  IP20    1,9600  1 m  05.20.02 



built-up ceiling light - directional - down  
Aufbau Deckenleuchte - schwenkbar - down

**Lamp type**  
1x QPAR70 GU10 max. 7W  230V

**Dimensions**  
L123xB123xH130

**Materials**  
aluminium 2

Ref	
1875.GU10.1M.1M	white tex
1875.GU10.2.2	black
1875.GU10.2M.2.14	black tex
1875.GU10.2M.2M	black tex
1875.GU10.11M.2.14	grey tex

built-up  
chrome on request  
Chrom auf Anfrage

1876.GU10../.. - SPINNER X AR70 GU10

~230V  IP20    2,9200  1 m  05.20.02 



built-up ceiling light - directional - down  
Aufbau Deckenleuchte - schwenkbar - down

**Lamp type**  
2x QPAR70 GU10 max. 7W  230V

**Dimensions**  
L252xB149xH130

**Materials**  
aluminium 2 | 1M | 2M | 11M

Ref	
1876.GU10.1M.1M	white tex
1876.GU10.2.2	black
1876.GU10.2M.2.14	black tex
1876.GU10.2M.2M	black tex
1876.GU10.2M.45	black tex
1876.GU10.11M.2.14	grey tex

built-up  
chrome on request  
Chrom auf Anfrage

1877.GU10../.. - SPINNER X AR70 GU10

~230V  IP20    1 m  05.20.02 



built-up ceiling light - directional - down  
Aufbau Deckenleuchte - schwenkbar - down

**Lamp type**  
3x QPAR70 GU10 max. 7W  230V

**Dimensions**  
L356xB149xH130

**Materials**  
aluminium 2 | 1M | 2M | 11M

Ref	
1877.GU10.1M.1M	white tex
1877.GU10.2.2	black
1877.GU10.2M.2	black tex
1877.GU10.2M.2.14	black tex
1877.GU10.11M.2.14	grey tex

built-up  
chrome on request  
Chrom auf Anfrage

1878.GU10/.. - SPINNER X AR70 GU10

~230V



built-up ceiling light - directional - down  
 Aufbau Deckenleuchte - schwenkbar - down

**Lamp type**

4x QPAR70 GU10 max. 7W ▶ **230V**

**Dimensions**

L460xB149xH130

**Materials**

aluminium **2 | 1M | 2M | 11M**

**Ref**

1878.GU10.1M.1M	white tex
1878.GU10.2.2	black
1878.GU10.2M.2.14	black tex
1878.GU10.2M.2M	black tex
1878.GU10.11M.2.14	grey tex

built-up  
 chrome on request  
 Chrom auf Anfrage

1880.GU10/.. - SPINNER X AR70 GU10

~230V



built-up ceiling light - directional - down  
 Aufbau Deckenleuchte - schwenkbar - down

**Lamp type**

4x QPAR70 GU10 max. 7W ▶ **230V**

**Dimensions**

L262xB262xH130

**Materials**

aluminium **2 | 1M | 2M | 11M**

**Ref**

1880.GU10.1M.1M	white tex
1880.GU10.2.2	black
1880.GU10.2M.2.14	black tex
1880.GU10.2M.2.2M	black tex
1880.GU10.11M.2.14	grey tex

built-up  
 chrome on request  
 2x105VA - Chrom auf Anfrage



1891/.. - SPINNER X

~230V



built-up ceiling light - directional - down  
Aufbau Deckenleuchte - schwenkbar - down

Lamp type

1x QPAR111 GU10 max. 12W **A+** - **D** 230V

Dimensions

L155xB155xH126

Materials

aluminium 1M | 2M

Ref

1891.1M.1M white tex  
1891.2M.2M black tex

built-up  
chrome on request  
Chrom auf Anfrage

1892/.. - SPINNER X

~230V



built-up ceiling light - directional - down  
Aufbau Deckenleuchte - schwenkbar - down

Lamp type

2x QPAR111 GU10 max. 12W **A+** - **D** 230V

Dimensions

L301xB155xH126

Materials

aluminium 1M | 2M | 11M

Ref

1892.1M.1M white tex  
1892.2M.2.14 black tex  
1892.2M.2.2M black tex  
1892.11M.2.14 grey tex

built-up  
chrome on request  
Chrom auf Anfrage

1893/.. - SPINNER X

~230V



built-up ceiling light - directional - down  
Aufbau Deckenleuchte - schwenkbar - down

Lamp type

3x QPAR111 GU10 max. 12W **A+** - **D** 230V

Dimensions

L448xB155xH126

Materials

aluminium 1M | 2M | 11M

Ref

1893.1M.1M white tex  
1893.2M.2.14 black tex  
1893.2M.2.2 black tex  
1893.11M.2.14 grey tex

built-up  
chrome on request  
Chrom auf Anfrage

1894/.. - SPINNER X

~230V



built-up ceiling light - directional - down  
Aufbau Deckenleuchte - schwenkbar - down

Lamp type

4x QPAR111 GU10 max. 12W **A+** - **D** 230V

Dimensions

L308xB308xH126

Materials

aluminium 1M | 2M | 11M

Ref

1894.1M.1M white tex  
1894.2M.2 black tex  
1894.2M.2.14 black tex  
1894.11M.2.14 grey tex

built-up  
chrome on request  
Chrom auf Anfrage

1861/.. - SPINNER X

~230V   IP20    4,5200 1 m 05.20.02 



built-up ceiling light - directional - down - with transformer  
Aufbau Deckenleuchte - schwenkbar - down - mit Trafo

**Lamp type**  
1x QR-LP111 G53 max. 50W  12V

**Dimensions**  
L155xB155xH126

**Materials**  
aluminium 2 | 1M | 2M | 11M

Ref	
1861.1M.1M	white tex
1861.2	black
1861.2M.2.14	black tex
1861.2M.2M	black tex
1861.11M.2.14	grey tex

built-up  
with LED-transformer - chrome on request  
mit LED-Trafo - Chrom auf Anfrage

1862/.. - SPINNER X

~230V   IP20    3,8000 1 m 05.20.02 



built-up ceiling light - directional - down - with transformer  
Aufbau Deckenleuchte - schwenkbar - down - mit Trafo

**Lamp type**  
2x QR-LP111 G53 max. 35W  12V

**Dimensions**  
L301xB155xH126

**Materials**  
aluminium 1M | 2M | 11M

Ref	
1862.1M.1M	white tex
1862.2M.2.14	black tex
1862.2M.2.2M	black tex
1862.2M.2M	black tex
1862.11M.2.14	grey tex

built-up  
with LED-transformer - chrome on request  
mit LED-Trafo - Farbe Chrom auf Anfrage

1863/.. - SPINNER X

~230V   IP20    5,4700 1 m 05.20.02 



built-up ceiling light - directional - down - with transformer  
Aufbau Deckenleuchte - schwenkbar - down - mit Trafo

**Lamp type**  
3x QR-LP111 G53 max. 35W  12V

**Dimensions**  
L448xB155xH126

**Materials**  
aluminium 1M | 2M | 11M

Ref	
1863.1M.1M	white tex
1863.2M.2.14	black tex
1863.2M.2.2M	black tex
1863.11M.2.14	grey tex

built-up  
with LED-transformer - chrome on request  
mit LED-Trafo - Farbe Chrom auf Anfrage

1868/.. - SPINNER X

~230V   IP20    6,9300 0,5 m 05.20.02 



built-up ceiling light - directional - down - with transformer  
Aufbau Deckenleuchte - schwenkbar - down - mit Trafo

**Lamp type**  
4x QR-LP111 G53 max. 35W  12V

**Dimensions**  
L308xB308xH130

**Materials**  
aluminium 1M | 2M | 11M

Ref	
1868.1M.1M	white tex
1868.2M.2.14	black tex
1868.2M.2.2M	black tex
1868.11M.2.14	grey tex



built-up  
with LED-transformer - chrome on request  
mit LED-Trafo - Chrom auf Anfrage

1957/.. - VOLTA

~12V   IP20       



built-up ceiling or wall light - directional - without transformer  
Decken- oder Wandleuchte für Aufbau - schwenkbar - ohne Trafo

**Lamp type**  
1x QR-LP70 BA15d max. 50W  -  12V

**Dimensions**  
Ø60xH160  
Ø60

**Materials**  
aluminium 10 | 14 | 1M | 2M  
brass 13 | 23

Ref	
1957.1M	white tex
1957.2M	black tex
1957.10	alu grey
1957.13	bronze
1957.14	alu satin
1957.23	dark bronze

built-up

1957.ES50/.. - VOLTA

~230V  IP20       



built-up ceiling or wall light - directional  
Decken- oder Wandleuchte für Aufbau - schwenkbar

**Lamp type**  
1x QPAR70 GU10 max. 7W  230V

**Dimensions**  
Ø60xH160  
Ø60

**Materials**  
aluminium 14 | 1M | 2M  
brass 13 | 23

Ref	
1957.ES50.1M	white tex
1957.ES50.2M	black tex
1957.ES50.13	bronze
1957.ES50.14	alu satin
1957.ES50.23	dark bronze

built-up

1959A/.. - VOLTA + JUBA 1

~230V   IP20       



built-up ceiling or wall light - directional - with transformer  
Decken- oder Wandleuchte für Aufbau - schwenkbar - mit Trafo

**Lamp type**  
1x QR-LP70 BA15d max. 50W  -  12V

**Dimensions**  
L100xB55xH160  
L100xB55

**Materials**  
aluminium 10 | 14 | 1M | 2M  
brass 13 | 23

Ref	
1959A.1M	white tex
1959A.2M	black tex
1959A.10	alu grey
1959A.13	bronze
1959A.14	alu satin
1959A.23	dark bronze

built-up  
with LED-transformer  
mit LED-Trafo

1959A.ES50/.. - VOLTA + JUBA 1

~230V  IP20      



built-up ceiling or wall light - directional  
Decken- oder Wandleuchte für Aufbau - schwenkbar

**Lamp type**  
1x QPAR70 GU10 max. 7W  230V

**Dimensions**  
L100xB55xH160  
L100xB55

**Materials**  
aluminium 14 | 1M | 2M  
brass 13 | 23

Ref	
1959A.ES50.1M	white tex
1959A.ES50.2M	black tex
1959A.ES50.13	bronze
1959A.ES50.14	alu satin
1959A.ES50.23	dark bronze

built-up





1959B/.. - VOLTA + JUBA 2

~230V   IP20    1,1890  0,5 m  05.20.02 



built-up ceiling or wall light - directional - with transformer  
Decken- oder Wandleuchte für Aufbau - schwenkbar - mit Trafo

**Lamp type**

2x QR-LP70 BA15d max. 50W  -  12V

**Dimensions**

L200xB55xH160

L200xB55

**Materials**

aluminium 10 | 14 | 1M | 2M

brass 13 | 23

**Ref**

1959B.1M	white tex
1959B.2M	black tex
1959B.10	alu grey
1959B.13	bronze
1959B.14	alu satin
1959B.23	dark bronze

built-up  
with LED-transformer  
mit LED-Trafo

1959B.ES50/.. - VOLTA + JUBA 2

~230V  IP20    0,5 m  05.20.02 



built-up ceiling or wall light - directional  
Decken- oder Wandleuchte für Aufbau - schwenkbar

**Lamp type**

2x QPAR70 GU10 max. 7W  230V

**Dimensions**

L200xB55xH160

L200xB55

**Materials**

aluminium 14 | 1M | 2M

brass 13 | 23

**Ref**

1959B.ES50.1M	white tex
1959B.ES50.2M	black tex
1959B.ES50.13	bronze
1959B.ES50.14	alu satin
1959B.ES50.23	dark bronze

built-up

105VA



Jij bent  
leuk  
mag ik  
jou  
houden?

# INDOOR | Ceiling UP | Luminaires | PULA

optional: assembly lamps + transformer/driver - not included

optional: Montage Leuchtmittel + Trafo/Treiber - nicht einbegriffen

## 5042/.. - PULA

~12V



built-up ceiling light - directional - with built-up base - without transformer  
 Aufbau Deckenleuchte - schwenkbar - ohne Trafo

### Lamp type

1x QR-LP70 BA15d max. 50W **A+** - **E** 12V

### Dimensions

Ø60xH90

### Materials

aluminium 1M | 2M  
 brass 23

### Ref

5042.1M white tex  
 5042.2M black tex  
 5042.23 dark bronze

built-up

## 5044/.. - PULA

~12V

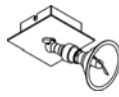

built-up ceiling light - directional - AR70 - without transformer  
 Aufbau Deckenleuchte - schwenkbar - AR70 - ohne Trafo

### Lamp type

1x QR-LP70 BA15d max. 50W **A+** - **E** 12V

### Dimensions

L130xB130xH110  
 Base - L100xB100xH32

### Materials

aluminium 1M | 2M  
 brass 23

### Ref

5044.1M white tex  
 5044.2M black tex  
 5044.23 dark bronze

built-up

## 5045/.. - PULA

~12V

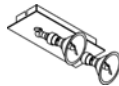

built-up ceiling light - directional - with 2 spots AR70 on kneejoint - without transformer  
 Aufbau Deckenleuchte - schwenkbar - mit 2 Strahler AR70 auf Kniegelenk - ohne Trafo

### Lamp type

2x QR-LP70 BA15d max. 50W **A+** - **E** 12V

### Dimensions

L215xB130xH110  
 Base - L185xB100xH32

### Materials

aluminium 1M | 2M  
 brass 23

### Ref

5045.1M white tex  
 5045.2M black tex  
 5045.23 dark bronze

built-up

## 5046/.. - PULA

~12V

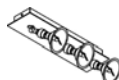

built-up ceiling light - directional - with 3 spots AR70 on kneejoint - without transformer  
 Aufbau Deckenleuchte - schwenkbar - mit 3 Strahler AR70 auf Kniegelenk - ohne Trafo

### Lamp type

3x QR-LP70 BA15d max. 50W **A+** - **E** 12V

### Dimensions

L300xB130xH110  
 Base - L270xB100xH32

### Materials

aluminium 1M | 2M  
 brass 23

### Ref

5046.1M white tex  
 5046.2M black tex  
 5046.23 dark bronze

built-up





# INDOOR | Ceiling UP | Luminaires | PULA

optional: assembly lamps + transformer/driver - not included

optional: Montage Leuchtmittel + Trafo/Treiber - nicht einbegriffen

## 5047/.. - PULA

~12V



built-up ceiling light - directional - with 4 spots AR70 on kneejoint - without transformer  
 Aufbau Deckenleuchte - schwenkbar - mit 4 Strahler AR70 auf Kniegelenk - ohne Trafo

### Ref

5047.1M

white tex

5047.2M

black tex

5047.23

dark bronze

### Lamp type

4x QR-LP70 BA15d max. 50W A+ - E 12V

### Dimensions

L385xB130xH110

Base - L355xB100xH32

### Materials

aluminium 1M | 2M

brass 23

built-up

## 5049/.. - PULA

~12V



built-up ceiling light - directional - with 2 spots AR70 on kneejoint - without transformer  
 Aufbau Deckenleuchte - schwenkbar - mit 2 Strahler AR70 auf Kniegelenk - ohne Trafo

### Ref

5049.1M

white tex

5049.2M

black tex

5049.23

dark bronze

### Lamp type

2x QR-LP70 BA15d max. 50W A+ - E 12V

### Dimensions

L110xB110xH120

Base - L110xB110xH45

### Materials

aluminium 1M | 2M

brass 23

built-up

## 5048/.. - PULA

~12V



built-up ceiling light - directional - with 4 spots AR70 on kneejoint - without transformer  
 Aufbau Deckenleuchte - schwenkbar - mit 4 Strahler AR70 auf Kniegelenk - ohne Trafo

### Ref

5048.1M

white tex

5048.2M

black tex

5048.23

dark bronze

### Lamp type

4x QR-LP70 BA15d max. 50W A+ - E 12V

### Dimensions

L215xB215xH110

Base - L185xB185xH32

### Materials

aluminium 1M | 2M

brass 23

built-up



4086.IP20/.. - FIXER XICATO

=500mA



built-up ceiling light - fixed - without LED driver  
Aufbau Deckenleuchte - fest - ohne Driver LED

**Lamp type**  
1x Led 965lm CRI80 max. 6,6W - 500mA

**Dimensions**  
L60xB60xH118  $\wedge$  40° reflector  
Reflector - Ø50

Ref	
4086.IP20.1M	NW   WW
4086.IP20.2M	NW   WW
4086.IP20.11M	NW   WW
4086.IP20.14	NW   WW

built-up

4087.IP20/.. - FIXER XICATO

~230V IP20



built-up ceiling light - fixed - not dimmable - with LED driver  
Aufbau Deckenleuchte - fest - nicht dimmbar - mit Driver LED

**Lamp type**  
1x Led 965lm CRI80 max. 6,6W - 500mA

**Dimensions**  
L60xB60xH138  $\wedge$  40° reflector  
Reflector - Ø50

Ref	
4087.IP20.1M	NW   WW
4087.IP20.2M	NW   WW
4087.IP20.11M	NW   WW
4087.IP20.14	NW   WW

built-up

4088.IP20/.. - FIXER XICATO

=500mA



built-up ceiling light - directional - without LED driver  
Aufbau Deckenleuchte - schwenkbar - ohne Driver LED

**Lamp type**  
1x Led 965lm CRI80 max. 6,6W - 500mA

**Dimensions**  
L60xB60xH120  $\wedge$  40° reflector  
Reflector - Ø50

Ref	
4088.IP20.1M	NW   WW
4088.IP20.2M	NW   WW
4088.IP20.11M	NW   WW
4088.IP20.14.11	NW   WW

built-up

4089.IP20/.. - FIXER XICATO

~230V IP20



built-up ceiling light - directional - not dimmable - with LED driver  
Aufbau Deckenleuchte - schwenkbar - nicht dimmbar - mit Driver LED

**Lamp type**  
1x Led 965lm CRI80 max. 6,6W - 500mA

**Dimensions**  
L60xB60xH140  $\wedge$  40° reflector  
Reflector - Ø50

Ref	
4089.IP20.1M	NW   WW
4089.IP20.2M	NW   WW
4089.IP20.11M	NW   WW
4089.IP20.14.11	NW   WW

built-up

4091.IP20/.. - FIXER XICATO

=700mA



built-up ceiling light - fixed - without LED driver  
Aufbau Deckenleuchte - fest - ohne Driver LED

Lamp type

1x Led 1300lm CRI80 max. 9,5W - 700mA

Dimensions

L80xB80xH118 40° reflector  
Reflector - Ø70

Ref

4091.IP20.1M	NW   WW
4091.IP20.2M	NW   WW
4091.IP20.11M	NW   WW
4091.IP20.14	NW   WW

built-up

4092.IP20/.. - FIXER XICATO

~230V



built-up ceiling light - fixed - not dimmable - with LED driver  
Aufbau Deckenleuchte - fest - nicht dimmbar - mit Driver LED

Lamp type

1x Led 1300lm CRI80 max. 9,5W - 700mA

Dimensions

L80xB80xH138 40° reflector  
Reflector - Ø70

Ref

4092.IP20.1M	NW   WW
4092.IP20.2M	NW   WW
4092.IP20.11M	NW   WW
4092.IP20.14	NW   WW

built-up

4093.IP20/.. - FIXER XICATO

=700mA



built-up ceiling light - directional - without LED driver  
Aufbau Deckenleuchte - schwenkbar - ohne Driver LED

Lamp type

1x Led 1300lm CRI80 max. 9,5W - 700mA

Dimensions

L80xB80xH120 40° reflector  
Reflector - Ø70

Ref

4093.IP20.1M	NW   WW
4093.IP20.2M	NW   WW
4093.IP20.11M	NW   WW
4093.IP20.14.11	NW   WW

built-up

4094.IP20/.. - FIXER XICATO

~230V



built-up ceiling light - directional - not dimmable - with LED driver  
Aufbau Deckenleuchte - schwenkbar - nicht dimmbar - mit Driver LED

Lamp type

1x Led 1300lm CRI80 max. 9,5W - 700mA

Dimensions

L80xB80xH140 40° reflector  
Reflector - Ø70

Ref

4094.IP20.1M	NW   WW
4094.IP20.2M	NW   WW
4094.IP20.11M	NW   WW
4094.IP20.14.11	NW   WW

built-up







4096.IP20/.. - FIXER XICATO

=700mA



built-up ceiling light - fixed - without LED driver  
 Aufbau Deckenleuchte - fest - ohne Driver LED

Lamp type

1x Led 2000lm CRI80 max. 15,2W - 700mA

Dimensions

40° reflector  
 Reflector - Ø111

Ref

4096.IP20.1M	NW   WW
4096.IP20.2M	NW   WW
4096.IP20.11M	NW   WW
4096.IP20.14	NW   WW

built-up

4097.IP20/.. - FIXER XICATO

~230V



built-up ceiling light - fixed - not dimmable - with LED driver  
 Aufbau Deckenleuchte - fest - nicht dimmbar - mit Driver LED

Lamp type

1x Led 2000lm CRI80 max. 15,2W - 700mA

Dimensions

40° reflector  
 Reflector - Ø111

Ref

4097.IP20.1M	NW   WW
4097.IP20.2M	NW   WW
4097.IP20.11M	NW   WW
4097.IP20.14	NW   WW

built-up

4098.IP20/.. - FIXER XICATO

=700mA



built-up ceiling light - directional - without LED driver  
 Aufbau Deckenleuchte - schwenkbar - ohne Driver LED

Lamp type

1x Led 2000lm CRI80 max. 15,2W - 700mA

Dimensions

40° reflector  
 Reflector - Ø111

Ref

4098.IP20.1M	NW   WW
4098.IP20.2M	NW   WW
4098.IP20.11M	NW   WW
4098.IP20.14.11	NW   WW

built-up

4099.IP20/.. - FIXER XICATO

~230V



built-up ceiling light - directional - not dimmable - with LED driver  
 Aufbau Deckenleuchte - schwenkbar - nicht dimmbar - mit Driver LED

Lamp type

1x Led 2000lm CRI80 max. 15,2W - 700mA

Dimensions

40° reflector  
 Reflector - Ø111

Ref

4099.IP20.1M	NW   WW
4099.IP20.2M	NW   WW
4099.IP20.11M	NW   WW
4099.IP20.14.11	NW   WW

built-up





4105.IP20/.. - FIXER XICATO



~230V    IP20    0,5 m  05.20.50  CE





built-up ceiling light - directional - not dimmable - with LED driver  
 Aufbau Deckenleuchte - schwenkbar - nicht dimmbar - mit Driver LED

Ref	
4105.IP20.1M	NW   WW
4105.IP20.2M	NW   WW

Lamp type

 1x Led 2000lm CRI80 max. 15,2W  -  700mA

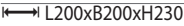
Dimensions

 L200xB200xH230  40° reflector  
 Reflector - Ø111

built-up

4110.IP20/.. - FIXER XICATO



=700mA   IP20    1,9550  0,5 m  05.20.50  CE





built-up ceiling light - fixed - down - without LED driver  
 Aufbau Deckenleuchte - fest - down - ohne Driver LED

Ref	
4110.IP20.1M	NW   WW
4110.IP20.2M	NW   WW
4110.IP20.11M	NW   WW
4110.IP20.14	NW   WW

Lamp type

 2x Led 1300lm CRI80 max. 9,5W  -  700mA

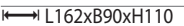
Dimensions

 L162xB90xH110  40° reflector  
 Reflector - Ø70

built-up

4111.IP20/.. - FIXER XICATO



~230V    IP20    1,9550  0,5 m  05.20.50  CE





built-up ceiling light - fixed - down - not dimmable - with LED driver  
 Aufbau Deckenleuchte - fest - down - nicht dimmbar - mit Driver LED

Ref	
4111.IP20.1M	NW   WW
4111.IP20.2M	NW   WW
4111.IP20.11M	NW   WW
4111.IP20.14	NW   WW

Lamp type

 2x Led 1300lm CRI80 max. 9,5W  -  700mA

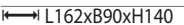
Dimensions

 L162xB90xH140  40° reflector  
 Reflector - Ø70

built-up

1496/.. - TORPEDO

~230V   IP20    1,3600  1 m  05.20.02 



built-up ceiling light - directional - with transformer  
Aufbau Deckenleuchte - schwenkbar - mit Trafo

Lamp type

1x QR-LP111 G53 max. 35W  12V

Dimensions

Ø124xH185-255

Ø90xH134

Materials

aluminium 14 | 1M | 2M

Ref

1496.1M	white tex
1496.2M	black tex
1496.14	alu satin

built-up  
with LED-transformer  
mit LED-Trafo

1498/.. - TORPEDO

~230V   IP20    2,8400  1 m  05.20.02 



built-up ceiling light - directional - with transformer  
Aufbau Deckenleuchte - schwenkbar - mit Trafo

Lamp type

2x QR-LP111 G53 max. 20W  12V

Dimensions

L455xB124xH150-215

L255xB90xH60

Materials

aluminium 14 | 1M | 2M





Ref

1498.1M	white tex
1498.2M	black tex
1498.14	alu satin

built-up  
with LED-transformer  
mit LED-Trafo





4081.IP20/.. - LUXOR UP XICATO



~230V    IP20      



built-up ceiling light - directional - down - with led - with LED driver  
 Aufbau Deckenleuchte - schwenkbar - down - mit Led - mit Driver LED

Ref	
4081.IP20.1M	NW   WW
4081.IP20.1M.2M	NW   WW
4081.IP20.2M	NW   WW

**Lamp type**  
 1x Led 1300lm CRI80 max. 9,5W  -  700mA

**Dimensions**  
 L240xB195xH160  40° reflector  
 Reflector - Ø111

built-up  
 dimmable phase-cut  
 dimmbar Phasenabschnitt

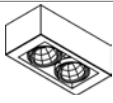

4082.IP20/.. - LUXOR UP XICATO

~230V    IP20       



built-up ceiling light - directional - down - with led - with LED driver  
 Aufbau Deckenleuchte - schwenkbar - down - mit Led - mit Driver LED

Ref	
4082.IP20.1M	NW   WW
4082.IP20.1M.2M	NW   WW
4082.IP20.2M	NW   WW

**Lamp type**  
 2x Led 1300lm CRI80 max. 9,5W  -  700mA

**Dimensions**  
 L391xB195xH160  40° reflector  
 Reflector - Ø111

built-up  
 dimmable phase-cut  
 dimmbar Phasenabschnitt



4083.IP20/.. - LUXOR UP XICATO



~230V    IP20      



built-up ceiling light - directional - down - with led - with LED driver  
 Aufbau Deckenleuchte - schwenkbar - down - mit Led - mit Driver LED



Ref	
4083.IP20.1M	NW   WW
4083.IP20.1M.2M	NW   WW
4083.IP20.2M	NW   WW

**Lamp type**  
 3x Led 1300lm CRI80 max. 9,5W  -  700mA

**Dimensions**  
 L542xB195xH160  40° reflector  
 Reflector - Ø111

built-up  
 dimmable phase-cut  
 dimmbar Phasenabschnitt

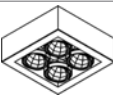

4084.IP20/.. - LUXOR UP XICATO

~230V    IP20      



built-up ceiling light - directional - down - with led - with LED driver  
 Aufbau Deckenleuchte - schwenkbar - down - mit Led - mit Driver LED

Ref	
4084.IP20.1M	NW   WW
4084.IP20.1M.2M	NW   WW
4084.IP20.2M	NW   WW

**Lamp type**  
 4x Led 1300lm CRI80 max. 9,5W  -  700mA

**Dimensions**  
 L390xB390xH160  40° reflector  
 Reflector - Ø111

built-up  
 dimmable phase-cut  
 dimmbar Phasenabschnitt

1980.IP20/.. - LUXOR UP XICATO

=700mA



built-up ceiling light - directional - down - with led - without LED driver  
 Aufbau Deckenleuchte - schwenkbar - down - mit Led - ohne Driver LED

Ref	
1980.IP20.1M	NW   WW
1980.IP20.1M.2M	NW   WW
1980.IP20.2M	NW   WW

**Lamp type**  
 1x Led 1300lm CRI80 max. 9,5W - 700mA

**Dimensions**  
 L159xB159xH130 40° reflector  
 Reflector - Ø70

built-up

1981.IP20/.. - LUXOR UP XICATO

~230V IP20

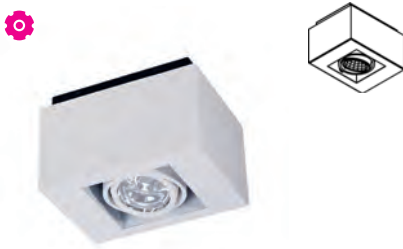

built-up ceiling light - directional - down - with led - with LED driver  
 Aufbau Deckenleuchte - schwenkbar - down - mit Led - mit Driver LED

Ref	
1981.IP20.1M	NW   WW
1981.IP20.1M.2M	NW   WW
1981.IP20.2M	NW   WW

**Lamp type**  
 1x Led 1300lm CRI80 max. 9,5W - 700mA

**Dimensions**  
 L200xB159xH130 40° reflector  
 Reflector - Ø70

built-up  
 dimmable phase-cut  
 dimmbar Phasenabschnitt

1982.IP20/.. - LUXOR UP XICATO

=700mA



built-up ceiling light - directional - down - with led - without LED driver  
 Aufbau Deckenleuchte - schwenkbar - down - mit Led - ohne Driver LED

Ref	
1982.IP20.1M	NW   WW
1982.IP20.1M.2M	NW   WW
1982.IP20.2M	NW   WW

**Lamp type**  
 2x Led 1300lm CRI80 max. 9,5W - 700mA

**Dimensions**  
 L262xB159xH130 40° reflector  
 Reflector - Ø70

built-up

1983.IP20/.. - LUXOR UP XICATO

~230V IP20



built-up ceiling light - directional - down - with led - with LED driver  
 Aufbau Deckenleuchte - schwenkbar - down - mit Led - mit Driver LED

Ref	
1983.IP20.1M	NW   WW
1983.IP20.1M.2M	NW   WW
1983.IP20.2M	NW   WW

**Lamp type**  
 2x Led 1300lm CRI80 max. 9,5W - 700mA

**Dimensions**  
 L302xB159xH130 40° reflector  
 Reflector - Ø70

built-up  
 dimmable phase-cut  
 dimmbar Phasenabschnitt





1984.IP20/.. - LUXOR UP XICATO

~230V         



built-up ceiling light - directional - down - with led - with LED driver  
 Aufbau Deckenleuchte - schwenkbar - down - mit Led - mit Driver LED

**Lamp type**  
 3x Led 1300lm CRI80 max. 9,5W  -  700mA

**Dimensions**  
 L405xB159xH130  40° reflector  
 Reflector - Ø70

**Ref**

1984.IP20.1M	NW   WW
1984.IP20.1M.2M	NW   WW
1984.IP20.2M	NW   WW



built-up  
 dimmable phase-cut  
 dimmbar Phasenabschnitt

1985.IP20/.. - LUXOR UP XICATO

~230V         



built-up ceiling light - directional - down - with led - with LED driver  
 Aufbau Deckenleuchte - schwenkbar - down - mit Led - mit Driver LED

**Lamp type**  
 4x Led 1300lm CRI80 max. 9,5W  -  700mA

**Dimensions**  
 L340xB340xH130  40° reflector  
 Reflector - Ø70

**Ref**

1985.IP20.1M	NW   WW
1985.IP20.1M.2M	NW   WW
1985.IP20.2M	NW   WW

built-up  
 dimmable phase-cut  
 dimmbar Phasenabschnitt



1986.IP20/.. - LUXOR UP XICATO

=700mA

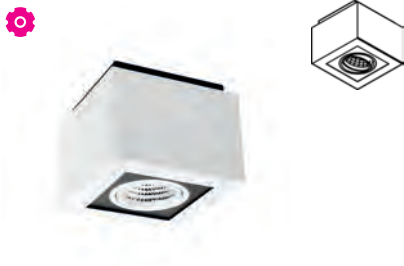

built-up ceiling light - directional - down - with led - without LED driver  
 Aufbau Deckenleuchte - schwenkbar - down - mit Led - ohne Driver LED

Ref	
1986.IP20.1M	NW   WW
1986.IP20.1M.2M	NW   WW
1986.IP20.2M	NW   WW

**Lamp type**  
 1x Led 1300lm CRI80 max. 9,5W - 700mA

**Dimensions**  
 L159xB159xH130 40° reflector  
 Reflector - Ø70

**built-up**  
 with closed cover plate - dimbaar phase-cut  
 mit geschlossener Abdeckplatte - dimmbar  
 Phasenabschnitt

1987.IP20/.. - LUXOR UP XICATO

~230V

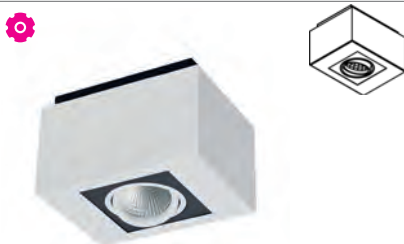

built-up ceiling light - directional - down - with led - with LED driver  
 Aufbau Deckenleuchte - schwenkbar - down - mit Led - mit Driver LED

Ref	
1987.IP20.1M	NW   WW
1987.IP20.1M.2M	NW   WW
1987.IP20.2M	NW   WW

**Lamp type**  
 1x Led 1300lm CRI80 max. 9,5W - 700mA

**Dimensions**  
 L200xB159xH130 40° reflector  
 Reflector - Ø70

**built-up**  
 with closed cover plate - dimmable phase-cut  
 mit geschlossener Abdeckplatte - dimmbar  
 Phasenabschnitt

1988.IP20/.. - LUXOR UP XICATO

~230V



built-up ceiling light - directional - down - with led - with LED driver  
 Aufbau Deckenleuchte - schwenkbar - down - mit Led - mit Driver LED

Ref	
1988.IP20.1M	NW   WW
1988.IP20.1M.2M	NW   WW
1988.IP20.2M	NW   WW

**Lamp type**  
 2x Led 1300lm CRI80 max. 9,5W - 700mA

**Dimensions**  
 L302xB159xH130 40° reflector  
 Reflector - Ø70

**built-up**  
 with closed cover plate - dimmable phase-cut  
 mit geschlossener Abdeckplatte - dimmbar  
 Phasenabschnitt

1989.IP20/.. - LUXOR UP XICATO

~230V



built-up ceiling light - directional - down - with led - with LED driver  
 Aufbau Deckenleuchte - schwenkbar - down - mit Led - mit Driver LED

Ref	
1989.IP20.1M	NW   WW
1989.IP20.1M.2M	NW   WW
1989.IP20.2M.1M	NW
1989.IP20.2M	NW   WW

**Lamp type**  
 3x Led 1300lm CRI80 max. 9,5W - 700mA

**Dimensions**  
 L405xB159xH130 40° reflector  
 Reflector - Ø70

**built-up**  
 with closed cover plate - dimmable phase-cut  
 mit geschlossener Abdeckplatte - dimmbar  
 Phasenabschnitt

1969.IP20/.. - LUXOR UP XICATO

~230V



LED C

IP20



4.6500

0.5 m

05.20.50



built-up ceiling light - directional - down - with led - with LED driver  
 Aufbau Deckenleuchte - schwenkbar - down - mit Led - mit Driver LED

**Lamp type**

4x Led 1300lm CRI80 max. 9,5W A - A 700mA

**Dimensions**

L340xB340xH130 40° reflector  
 Reflector - Ø70

**Ref**

1969.IP20.1M	NW   WW
1969.IP20.1M.2M	NW   WW
1969.IP20.2M	NW   WW

*built-up  
 with closed cover plate - dimmable phase-cut  
 mit geschlossener Abdeckplatte - dimmbar  
 Phasenabschnitt*

LUMINAIRES





W739/.. - POLO

~230V IP44 1,1200 0,5 m 05.20.02



built-up ceiling light - fixed - down  
Aufbau Deckenleuchte - fest - down

Lamp type

1x TCR-TSE GX53 max. 5W **A** - **E** 230V

Dimensions

L120xB120xH75

Materials

INOX 32X | 46X | 53X | 64X | 31MX | 33MX  
INOX 316 5 | 5BB

Ref

.5	inox 316
.5BB	inox 316 2x coated
.31MX	white texture
.32X	black texture
.33MX	brown texture
.46X	grey-brown
.53X	bronze-brown
.64X	black grey

built-up

W740/.. - POLO

~230V IP44 3,7000 0,5 m 05.20.02



built-up ceiling light - fixed - down  
Aufbau Deckenleuchte - fest - down

Lamp type

1x A60 E27 max. 60W **A** - **E** 230V

or 1x ST64 E27 max. 60W **A** - **E** 230V

Dimensions

L240xB240xH128

Materials

INOX 32X | 46X | 53X | 64X | 31MX | 33MX  
INOX 316 5 | 5BB

Ref

W740.5	inox 316
W740.5BB	inox 316 2x coated
W740.31MX	white texture
W740.32X	black texture
W740.33MX	brown texture
W740.46X	grey-brown
W740.53X	bronze-brown
W740.64X	black grey

built-up

W741/.. - POLO

~230V IP44 5,2200 0,5 m 05.20.02

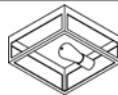

built-up ceiling light - fixed - down  
Aufbau Deckenleuchte - fest - down

Lamp type

1x A60 E27 max. 60W **A** - **E** 230V

or 1x ST64 E27 max. 60W **A** - **E** 230V

Dimensions

L320xB320xH128

Materials

INOX 32X | 46X | 53X | 64X | 31MX | 33MX  
INOX 316 5 | 5BB

Ref

W741.5	inox 316
W741.5BB	inox 316 2x coated
W741.31MX	white texture
W741.32X	black texture
W741.33MX	brown texture
W741.46X	grey-brown
W741.53X	bronze-brown
W741.64X	black grey

built-up

W741.B/.. - POLO

~230V IP44 5,6600 0,5 m 05.20.02

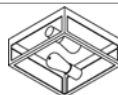

built-up ceiling light - fixed - down  
Aufbau Deckenleuchte - fest - down

Lamp type

2x A60 E27 max. 60W **A** - **E** 230V

or 2x ST64 E27 max. 60W **A** - **E** 230V

Dimensions

L320xB320xH128

Materials

INOX 32X | 46X | 53X | 64X | 31MX | 33MX  
INOX 316 5 | 5BB

Ref

W741.B.5	inox 316
W741.B.5BB	inox 316 2x coated
W741.B.31MX	white texture
W741.B.32X	black texture
W741.B.33MX	brown texture
W741.B.46X	grey-brown
W741.B.53X	bronze-brown
W741.B.64X	black grey

built-up



W778/.. - POLO

~230V



IP44



built-up ceiling light - fixed - down  
Aufbau Deckenleuchte - fest - down

Lamp type

1x A60 E27 max. 40W A - E 230V

Dimensions

L136xB136xH210

L120xB120xH30

Head - L136xB136xH180

Materials

INOX 32X | 46X | 53X | 64X | 31MX | 33MX

INOX 316 5 | 5BB

Ref

W778.5

W778.5BB

W778.31MX

W778.32X

W778.33MX

W778.46X

W778.53X

W778.64X

inox 316

inox 316 2x coated

white texture

black texture

brown texture

grey-brown

bronze-brown

black grey

built-up

W760A/.. - POLO

~230V



IP44

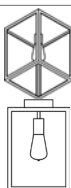

built-up ceiling light - fixed - down  
Aufbau Deckenleuchte - fest - down

Lamp type

1x A60 E27 max. 60W A - E 230V

or 1x ST64 E27 max. 60W A - E 230V

Dimensions

L240xB220xH380

L110xB110xH30

Head - L240xB220xH320

Materials

INOX 32X | 46X | 53X | 64X | 31MX | 33MX

INOX 316 5 | 5BB

Ref

W760A.5

W760A.5BB

W760A.31MX

W760A.32X

W760A.33MX

W760A.46X

W760A.53X

W760A.64X

inox 316

inox 316 2x coated

white texture

black texture

brown texture

grey-brown

bronze-brown

black grey

built-up



**W779/.. - POLO**

~230V



built-up ceiling light - fixed - down  
Aufbau Deckenleuchte - fest - down

**Lamp type**

1x ST64 E27 max. 40W **A** - **E** **230V**

**Dimensions**

L240xB240xH270

L80xB80xH30

Head - L240xB240xH240

**Materials**

INOX 32X | 46X | 53X | 64X | 31MX | 33MX  
INOX 316 5 | 5BB

**Ref**

W779.5	inox 316
W779.5BB	inox 316 2x coated
W779.31MX	white texture
W779.32X	black texture
W779.33MX	brown texture
W779.46X	grey-brown
W779.53X	bronze-brown
W779.64X	black grey

built-up

**W742/.. - POLO**

~230V



built-up ceiling light - fixed - down  
Aufbau Deckenleuchte - fest - down

**Lamp type**

1x A60 E27 max. 60W **A** - **E** **230V**

or 1x ST64 E27 max. 60W **A** - **E** **230V**

**Dimensions**

L240xB240xH350

L80xB80xH30

Head - L240xB240xH320

**Materials**

INOX 32X | 46X | 53X | 64X | 31MX | 33MX  
INOX 316 5 | 5BB

**Ref**

W742.5	inox 316
W742.5BB	inox 316 2x coated
W742.31MX	white texture
W742.32X	black texture
W742.33MX	brown texture
W742.46X	grey-brown
W742.53X	bronze-brown
W742.64X	black grey

built-up

1545LED/.. - WING LED

~230V  IP20      



ceiling light - fixed - down - with led  
Deckenleuchte - fest - down - mit Led

**Lamp type**  
2x led 750lm max. 9W  230V







**Dimensions**  
L300xB300xH70

**Materials**  
aluminium 14 | 1M | 2M

**Ref**  
1545LED.1M.NW white tex  
1545LED.2M.NW black tex  
1545LED.14.NW alu satin

*built-up*  
Dimmable phase-cut  
Phasenabschnitt

1546LED/.. - WING LED

~230V  IP20      



ceiling light - fixed - down - with led  
Deckenleuchte - fest - down - mit Led

**Lamp type**  
8x led 750lm max. 9W  230V







**Dimensions**  
L600xB600xH70

**Materials**  
aluminium 14 | 1M | 2M

**Ref**  
1546LED.1M.NW white tex  
1546LED.2M.NW black tex  
1546LED.14.NW alu satin

*built-up*  
Dimmable phase-cut  
Phasenabschnitt

1547LED/.. - WING LED

~230V  IP20      



ceiling light - fixed - down - with led  
Deckenleuchte - fest - down - mit Led

**Lamp type**  
4x led 750lm max. 9W  230V







**Dimensions**  
L600xB300xH70

**Materials**  
aluminium 14 | 1M | 2M

**Ref**  
1547LED.1M.NW white tex  
1547LED.2M.NW black tex  
1547LED.14.NW alu satin

*built-up*  
Dimmable phase-cut  
Phasenabschnitt

1548LED/.. - WING LED

~230V  IP20      

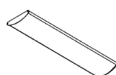

ceiling light - fixed - down - with led  
Deckenleuchte - fest - down - mit Led

**Lamp type**  
8x led 750lm max. 9W  230V

**Dimensions**  
L1200xB300xH70

**Materials**  
aluminium 14 | 1M | 2M

**Ref**  
1548LED.1M.NW white tex  
1548LED.2M.NW black tex  
1548LED.14.NW alu satin

*built-up*  
Dimmable phase-cut  
Phasenabschnitt





# INDOOR PROFILES

# Index

## B

BUTTERFLY 507

## C

CLIP DOUBLE 510

CLIP LED 508-509

## L

LINEA 512

## M

METRO 513-514

MIKADO 515

## S

STELLA LINE 504-505

## T

TIMES CROSS 502

TIMES GRID 500

TIMES KADER 502

TIMES 45X45 495-496

TIMES 45X70 498

TIMES 60X85 495

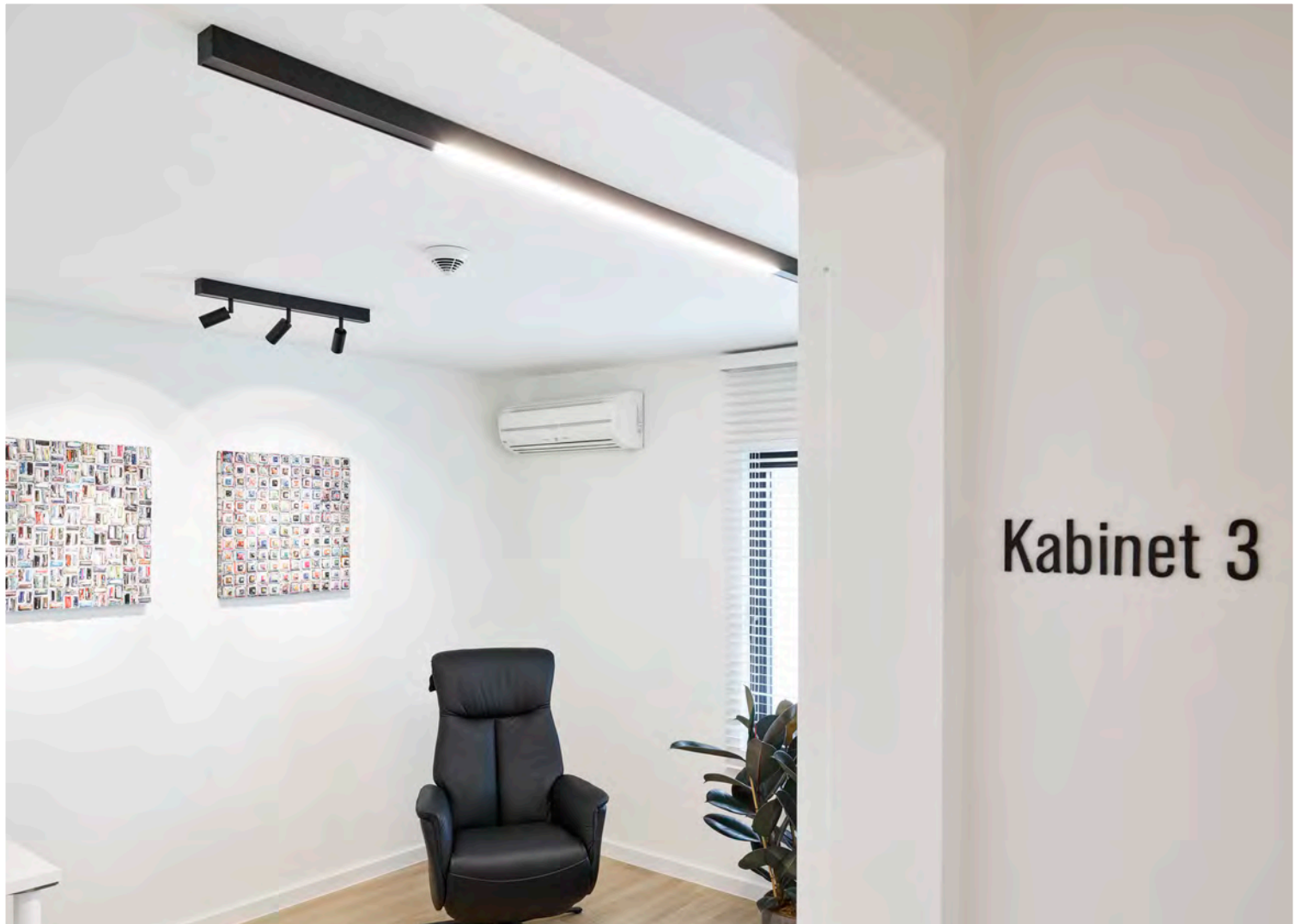

Kabinet 3

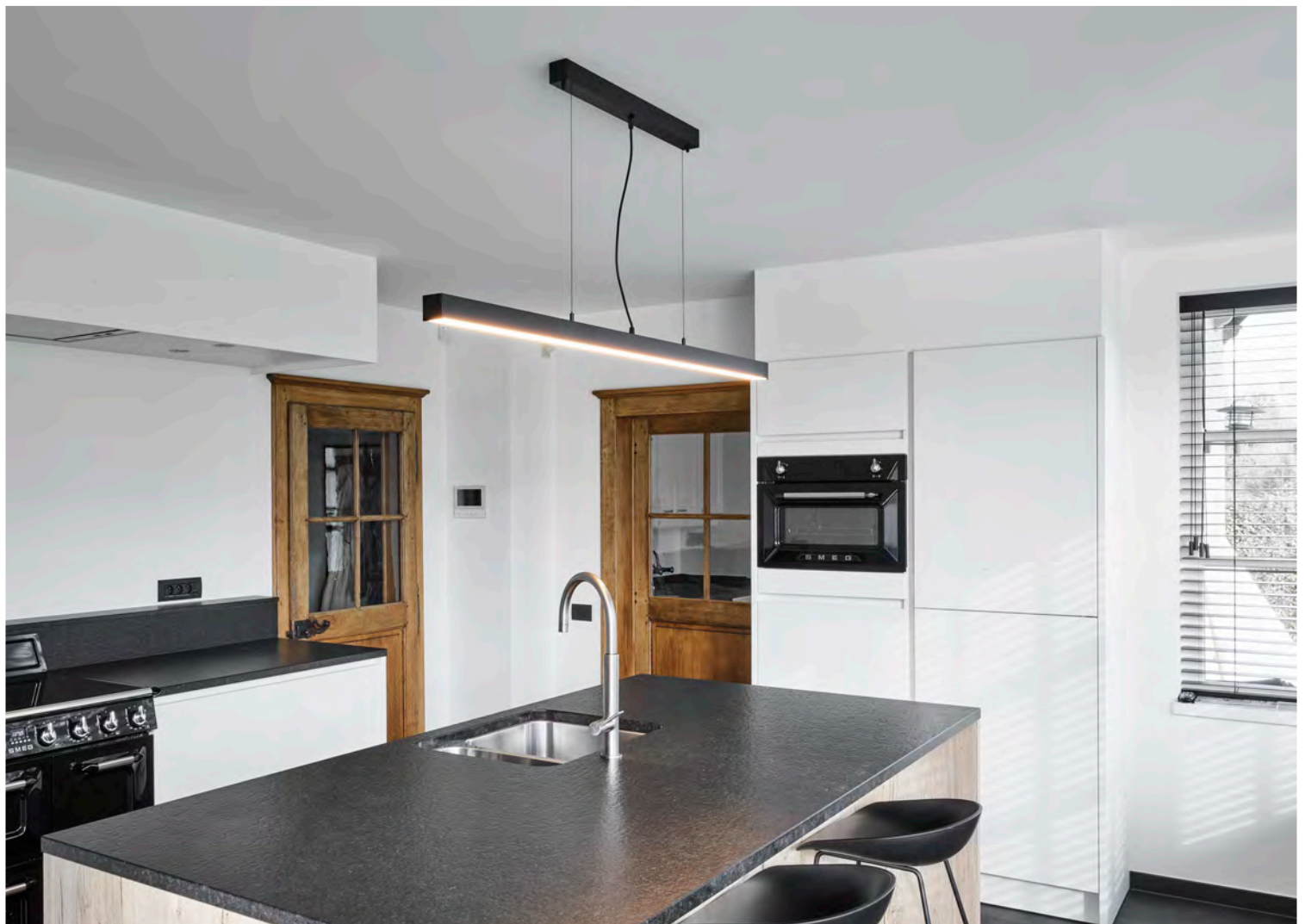

Colour 14 (alu satin) on request for profiles up to 2m

Farbe 14 (alu satin) auf Anfrage für Profile bis 2m

2980/.. - TIMES T5-60X85

~230V  IP20     









lighting system - mounting directly on the ceiling - with electronic gear  
Lichtsystem - Befestigung direkt an der Decke - mit elektronischem Vorschaltgerät



Reference	Colours	Length	LED	Type of lamp
2980.600	1M   2M	600		1x T16FQ T5 G5 max. 24W / 230V
2980.900	1M   2M	900		1x T16FH T5 G5 max. 21W / 230V
2980.1200	1M   2M	1200		1x T16FH T5 G5 max. 54W / 230V
2980.1500	1M   2M	1500		1x T16FQ T5 G5 max. 49W / 230V

built-up

2981/.. - TIMES LED 60X85

~230V  IP20     



lighting system - mounting directly on the ceiling  
Lichtsystem - Befestigung direkt an der Decke



Reference	Colours	Length	LED	Type of lamp
2981.850	1M   2M	850	NW   WW	3x led 750lm max. 9W / 230V
2981.1130	1M   2M	1130	NW   WW	4x led 750lm max. 9W / 230V
2981.1410	1M   2M	1410	NW   WW	5x led 750lm max. 9W / 230V
2981.1690	1M   2M	1690	NW   WW	6x led 750lm max. 9W / 230V
2981.1970	1M   2M	1970	NW   WW	7x led 750lm max. 9W / 230V
2981.2250	1M   2M	2250	NW   WW	8x led 750lm max. 9W / 230V

built-up  
dimmable phase-cut  
dimmbar Phasenabschnitt

2985/.. - TIMES T5-60x85

~230V  IP20      



lighting system - with suspension - with electronic gear  
Lichtsystem - mit Aufhängung - mit elektronischem Vorschaltgerät



Reference	Colours	Length	LED	Type of lamp
2985.600	1M   2M	600		1x T16FQ T5 G5 max. 24W / 230V
2985.900	1M   2M	900		1x T16FH T5 G5 max. 21W / 230V
2985.1200	1M   2M	1200		1x T16FH T5 G5 max. 54W / 230V
2985.1500	1M   2M	1500		1x T16FQ T5 G5 max. 49W / 230V

built-up

2987/.. - TIMES LED 60X85

~230V  IP20      



lighting system - with suspension  
Lichtsystem - mit Aufhängung



Reference	Colours	Length	LED	Type of lamp
2987.850	1M   2M	850	NW   WW	3x led 750lm max. 9W / 230V
2987.1130	1M   2M	1130	NW   WW	4x led 750lm max. 9W / 230V
2987.1410	1M   2M	1410	NW   WW	5x led 750lm max. 9W / 230V
2987.1690	1M   2M	1690	NW   WW	6x led 750lm max. 9W / 230V
2987.1970	1M   2M	1970	NW   WW	7x led 750lm max. 9W / 230V
2987.2250	1M   2M	2250	NW   WW	8x led 750lm max. 9W / 230V

built-up  
dimmable phase-cut  
dimmbar Phasenabschnitt



# INDOOR | Ceiling UP | Profiles | TIMES

Colour 14 (alu satin) on request for profiles up to 2m

Farbe 14 (alu satin) auf Anfrage für Profile bis 2m

## 2900/.. - TIMES LED 45X45

~230V



lighting system - with suspension - with LED driver  
Lichtsystem - mit Aufhängung - mit Driver LED

### Dimensions

L600xB45xH45

Reference	Colours	Length	LED	Type of lamp
2900.850	1M   2M	850	CW   NW   WW	3x Led 1250lm CRI80 max. 7,4W / 325mA
2900.1130	1M   2M	1130	CW   NW   WW	4x Led 1250lm CRI80 max. 7,4W / 325mA
2900.1410	1M   2M	1410	CW   NW   WW	5x Led 1250lm CRI80 max. 7,4W / 325mA
2900.1690	1M   2M	1690	CW   NW   WW	6x Led 1250lm CRI80 max. 7,4W / 325mA
2900.1970	1M   2M	1970	CW   NW   WW	7x Led 1250lm CRI80 max. 7,4W / 325mA
2900.2250	1M   2M	2250	CW   NW   WW	8x Led 1250lm CRI80 max. 7,4W / 325mA

### built-up

dimnable on request DALI/PUSH - 1-10V  
dimmbar auf Anfrage DALI/PUSH - 1-10V

## 2925/.. - TIMES LED 45X45 EX T

~230V



lighting system - mounting directly against ceiling - driver  
outside profile - delivered separately - with LED driver  
Lichtsystem - Befestigung direkt an der Decke - Treiber  
separat mitgeliefert - mit Driver LED

Reference	Colours	Length	LED	Type of lamp
2925.850	1M   2M	850	CW   NW   WW	3x Led 1250lm CRI80 max. 7,4W / 325mA
2925.1130	1M   2M	1130	CW   NW   WW	4x Led 1250lm CRI80 max. 7,4W / 325mA
2925.1410	1M   2M	1410	CW   NW   WW	5x Led 1250lm CRI80 max. 7,4W / 325mA
2925.1690	1M   2M	1690	CW   NW   WW	6x Led 1250lm CRI80 max. 7,4W / 325mA
2925.1970	1M   2M	1970	CW   NW   WW	7x Led 1250lm CRI80 max. 7,4W / 325mA
2925.2250	1M   2M	2250	CW   NW   WW	8x Led 1250lm CRI80 max. 7,4W / 325mA
2925.2530	1M   2M	2500	CW   NW   WW	9x Led 1250lm CRI80 max. 7,4W / 325mA

### built-up

drivers at distance - dimmable on request DALI/PUSH - 1-10V  
Treiber auf Abstand - dimmbar auf Anfrage DALI/PUSH - 1-10V  
3-7 modules : 2 wires - 8-9 modules : 4 wires  
3-7 Module: 2 Kabel - 8-9 Module: 4 Kabel







# INDOOR | Ceiling UP | Profiles | TIMES

Colour 14 (alu satin) on request for profiles up to 2m

Farbe 14 (alu satin) auf Anfrage für Profile bis 2m

## 2920/.. - TIMES LED 45X70

~230V



lighting system - with suspension - with LED driver  
Lichtsystem - mit Aufhängung - mit Driver LED

Reference	Colours	Length	LED	Type of lamp
2920.850	1M   2M	850	CW   NW   WW	3x Led 1250lm CRI80 max. 7,4W / 325mA
2920.1130	1M   2M	1130	CW   NW   WW	4x Led 1250lm CRI80 max. 7,4W / 325mA
2920.1410	1M   2M	1410	CW   NW   WW	5x Led 1250lm CRI80 max. 7,4W / 325mA
2920.1690	1M   2M	1690	CW   NW   WW	6x Led 1250lm CRI80 max. 7,4W / 325mA
2920.1970	1M   2M	1970	CW   NW   WW	7x Led 1250lm CRI80 max. 7,4W / 325mA
2920.2250	1M   2M	2250	CW   NW   WW	8x Led 1250lm CRI80 max. 7,4W / 325mA
2920.2530	1M   2M	2530	CW   NW   WW	9x Led 1250lm CRI80 max. 7,4W / 325mA
2920.2810	1M   2M	2810	CW   NW   WW	10x Led 1250lm CRI80 max. 7,4W / 325mA
2920.3090	1M   2M	3090	CW   NW   WW	11x Led 1250lm CRI80 max. 7,4W / 325mA

built-up

dimmmable on request DALI/PUSH - 1-10V

dimmmbar auf Anfrage DALI/PUSH - 1-10V

## 2930/.. - TIMES LED 45X70

~230V



lighting system - mounting directly on the ceiling - with LED driver  
Lichtsystem - Befestigung direkt an der Decke - mit Driver LED

Reference	Colours	Length	LED	Type of lamp
2930.850	1M   2M	850	CW   NW   WW	3x Led 1250lm CRI80 max. 7,4W / 325mA
2930.1130	1M   2M	1130	CW   NW   WW	4x Led 1250lm CRI80 max. 7,4W / 325mA
2930.1410	1M   2M	1410	CW   NW   WW	5x Led 1250lm CRI80 max. 7,4W / 325mA
2930.1690	1M   2M	1690	CW   NW   WW	6x Led 1250lm CRI80 max. 7,4W / 325mA
2930.1970	1M   2M	1970	CW   NW   WW	7x Led 1250lm CRI80 max. 7,4W / 325mA
2930.2250	1M   2M	2250	CW   NW   WW	8x Led 1250lm CRI80 max. 7,4W / 325mA
2930.2530	1M   2M	2530	CW   NW   WW	9x Led 1250lm CRI80 max. 7,4W / 325mA
2930.2810	1M   2M	2810	CW   NW   WW	10x Led 1250lm CRI80 max. 7,4W / 325mA
2930.3090	1M   2M	3090	CW   NW   WW	11x Led 1250lm CRI80 max. 7,4W / 325mA

built-up

dimmmable on request DALI/PUSH - 1-10V

dimmmbar auf Anfrage DALI/PUSH - 1-10V

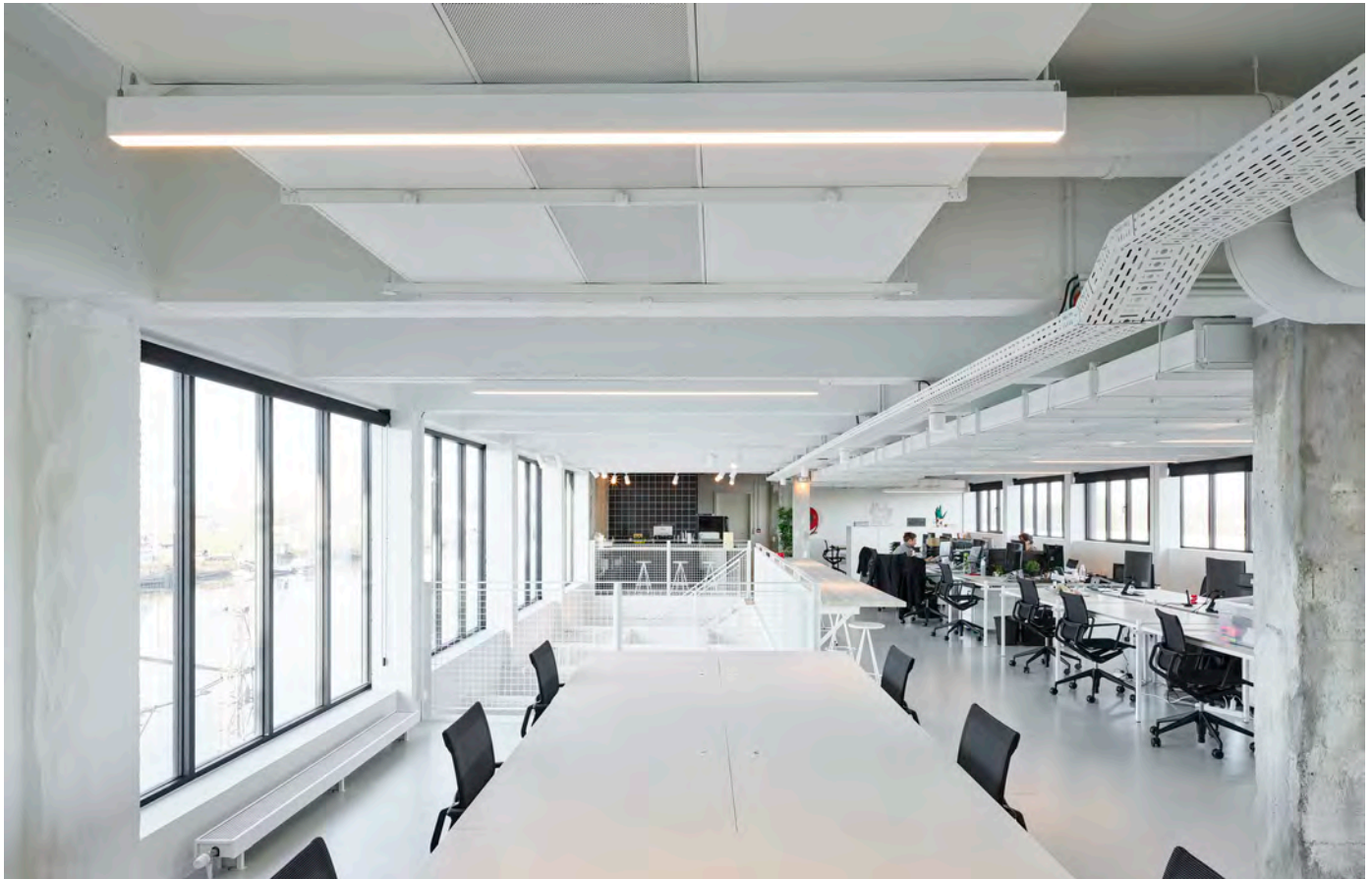

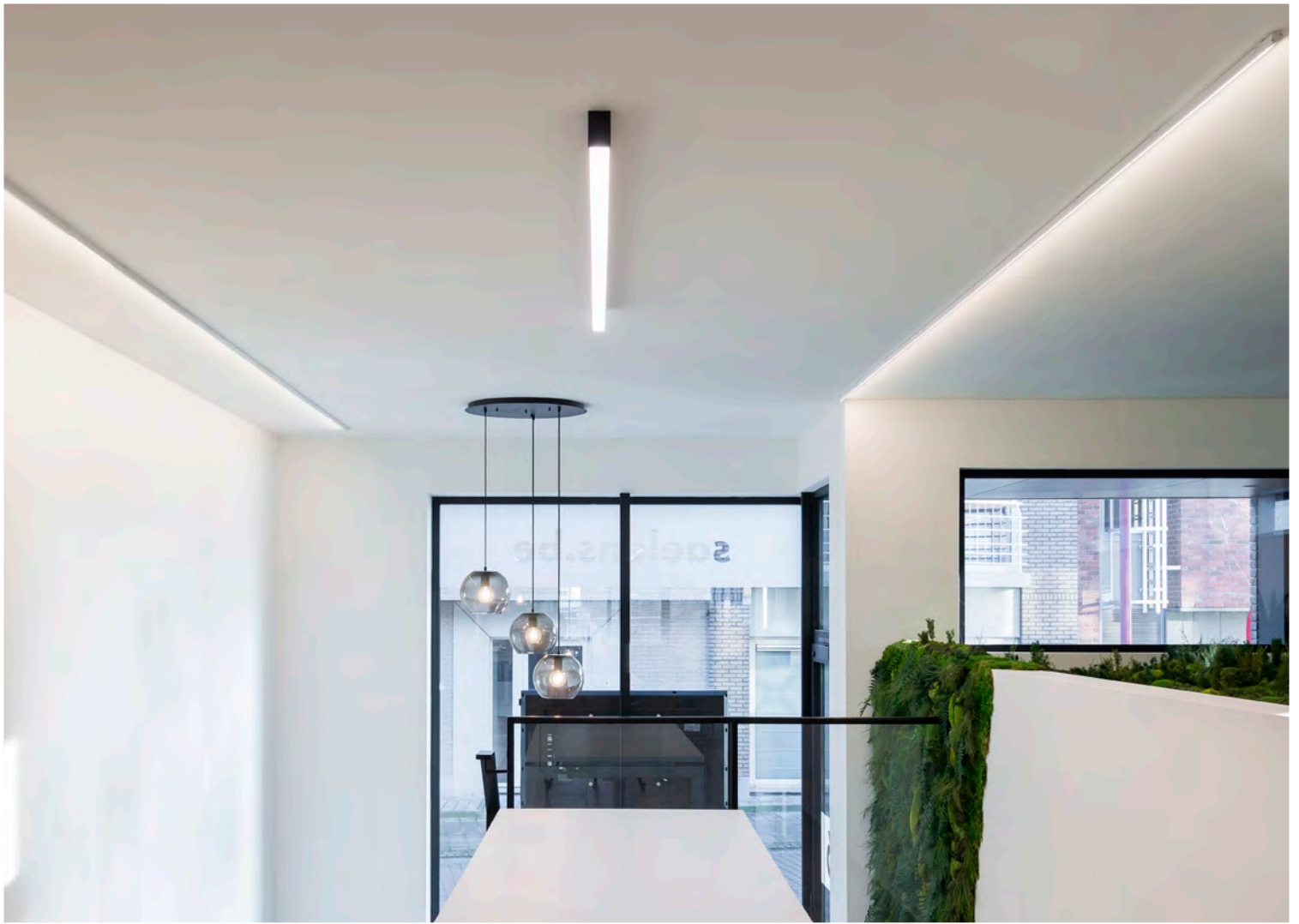



# INDOOR | Ceiling UP | Profiles | TIMES

Colour 14 (alu satin) on request for profiles up to 2m

Farbe 14 (alu satin) auf Anfrage für Profile bis 2m

## 2905/.. - TIMES GRID

~230V   IP20    0 m  0.5 m  05.20.50 

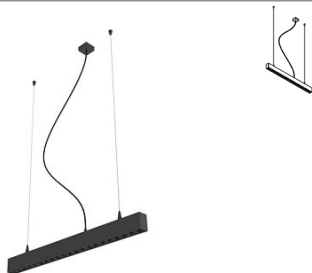

lighting system - with suspension - with LED driver  
Lichtsystem - mit Aufhängung - mit Driver LED

Reference	Colours	Length	LED	Type of lamp
2905.850	1M	850	CW   NW	3x LED 1160lm CRI90 max. 7,7W / 200mA
2905.850	2M	850	CW   NW	3x LED 1160lm CRI90 max. 7,7W / 200mA
2905.1130	1M	1130	CW   NW	4x LED 1160lm CRI90 max. 7,7W / 200mA
2905.1130	2M	1130	CW   NW	4x LED 1160lm CRI90 max. 7,7W / 200mA
2905.1410	1M	1410	CW   NW	5x LED 1160lm CRI90 max. 7,7W / 200mA
2905.1410	2M	1410	CW   NW	5x LED 1160lm CRI90 max. 7,7W / 200mA
2905.1690	1M	1690	CW   NW	6x LED 1160lm CRI90 max. 7,7W / 200mA
2905.1690	2M	1690	CW   NW	6x LED 1160lm CRI90 max. 7,7W / 200mA
2905.1970	1M	1970	CW   NW	7x LED 1160lm CRI90 max. 7,7W / 200mA
2905.1970	2M	1970	CW   NW	7x LED 1160lm CRI90 max. 7,7W / 200mA

### built-up

dimnable on request DALI/PUSH - 1-10V

dimmbar auf Anfrage DALI/PUSH - 1-10V

Colour 2M with black steel cable

Farbe 2M mit schwarzem Stahlkabel

## 2915/.. - TIMES GRID

~230V   IP20    0.5  05.20.50 

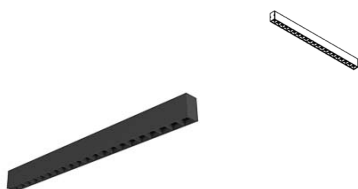

lighting system - mounting directly on the ceiling - with LED driver  
Lichtsystem - Befestigung direkt an der Decke - mit Driver LED

Reference	Colours	Length	LED	Type of lamp
2915.850	1M   2M	850	CW   NW	3x LED 1160lm CRI90 max. 7,7W / 200mA
2915.1130	1M   2M	1130	CW   NW	4x LED 1160lm CRI90 max. 7,7W / 200mA
2915.1410	1M   2M	1410	CW   NW	5x LED 1160lm CRI90 max. 7,7W / 200mA
2915.1690	1M   2M	1690	CW   NW	6x LED 1160lm CRI90 max. 7,7W / 200mA
2915.1970	1M   2M	1970	CW   NW	7x LED 1160lm CRI90 max. 7,7W / 200mA

### built-up

dimnable on request DALI/PUSH - 1-10V

dimmbar auf Anfrage DALI/PUSH - 1-10V







# INDOOR | Ceiling UP | Profiles | TIMES

Colour 14 (alu satin) on request for profiles up to 2m

Farbe 14 (alu satin) auf Anfrage für Profile bis 2m

## 2986/.. - TIMES CROSS

~230V



IP20



1,5 m



0,5



05.20.50



lighting system - with suspension - made to measure - with LED driver  
 Lichtsystem - mit Aufhängung - Maßgeschneidert - mit Driver LED

Ref

2986.1M

CW | NW

2986.2M

CW | NW

Lamp type

6x Led 1250lm CRI80 max. 7,8W A - A+ 250mA

**built-up**

specify dimensions for quotation

Geben Sie die richtigen Abmessungen für das Angebot an

## 2988/.. - TIMES KADER

~230V



IP20



1,5 m



7,2000



0,5



05.20.50



lighting system - with suspension - made to measure - with LED driver  
 Lichtsystem - mit Aufhängung - Maßgeschneidert - mit Driver LED

Ref

2988.1M

CW | NW | WW

2988.2M

CW | NW | WW

Lamp type

12x Led 1250lm CRI80 max. 7,4W A - A+ 325mA

**built-up**

specify dimensions for quotation

Geben Sie die richtigen Abmessungen für das Angebot an

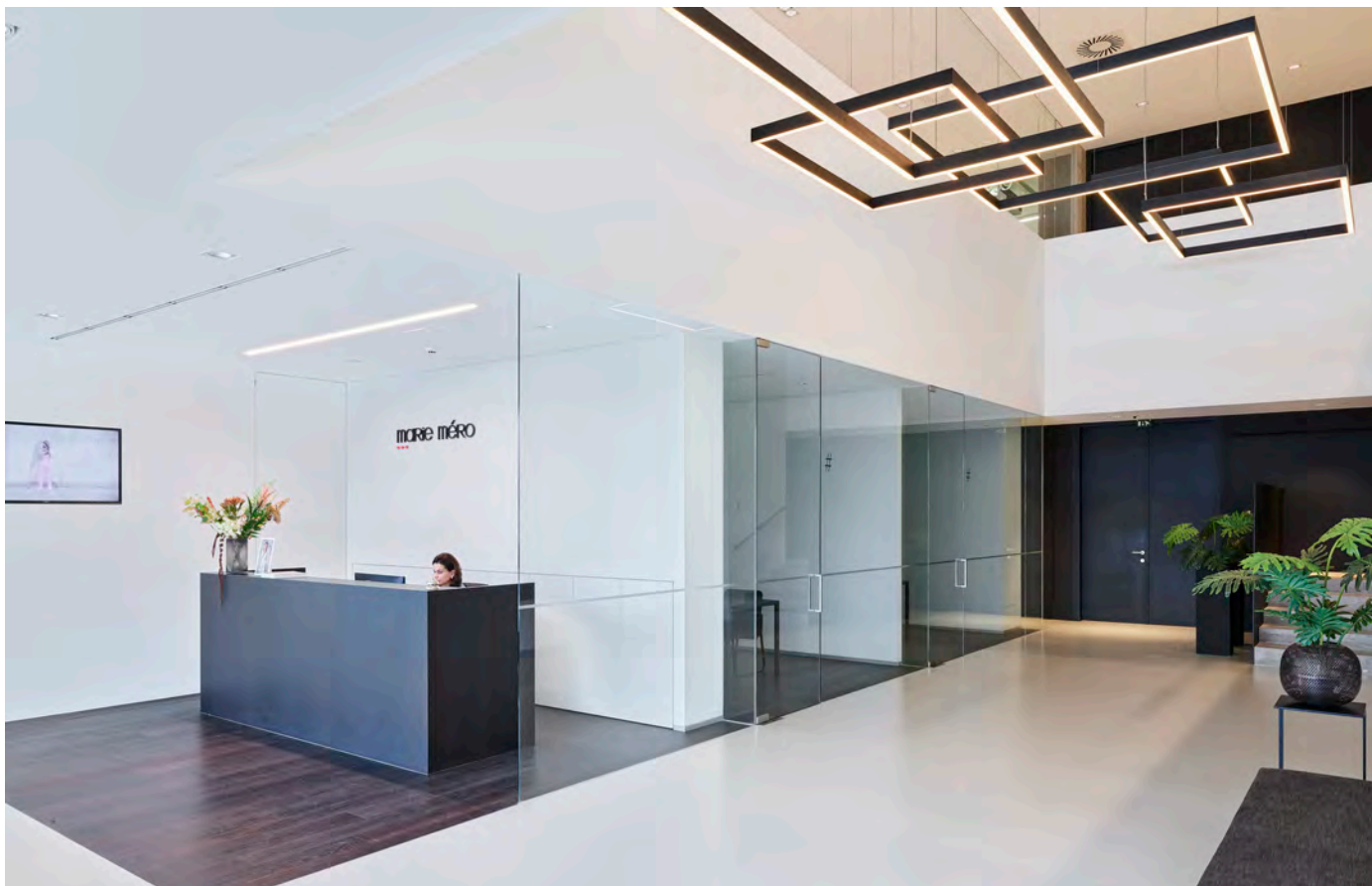









2918.1400/.. - STELLA LINE

~230V  IP20  0,5 m  



fixed - down - profile with 3x3 ZIA LED - with LED driver  
fest - down - Profil mit 3x3 ZIA LED - mit Driver LED

**Lamp type**  
 9x led 467lm CRI80 max. 3,8W  -  350mA

**Dimensions**  
 L1400xB45xH70  38

Ref	
2918.1400.1M	NW   WW
2918.1400.2M	NW   WW
2918.1400.47	NW   WW



**built-up**  
 500mA - 5,8W - 570 lm on request | other dimensions on request  
 500mA - 5,8W - 570 lm auf Anfrage | andere Abmessungen auf Anfrage  
 other dimming methods possible on request  
 andere Dimmtechniken auf Anfrage möglich



2919.1400/.. - STELLA LINE

~230V  IP20  0,5 m  



fixed - down - profile with 2x3 ZIA LED - with LED driver  
fest - down - Profil mit 2x3 ZIA LED - mit Driver LED

**Lamp type**  
 6x led 467lm CRI80 max. 3,8W  -  350mA

**Dimensions**  
 L1400xB45xH70  38

Ref	
2919.1400.1M	NW   WW
2919.1400.2M	NW   WW
2919.1400.47	NW   WW



**built-up**  
 500mA - 5,8W - 570 lm on request | other dimensions on request  
 500mA - 5,8W - 570 lm auf Anfrage | andere Abmessungen auf Anfrage  
 other dimming methods possible on request  
 andere Dimmtechniken auf Anfrage möglich

2945.1400/.. - STELLA LINE

~230V  IP20  0,5 m  



fixed - down - profile with 2x4 ZIA LED fixed - with LED driver  
fest - down - Profil mit 2x4 ZIA LED fest - mit Driver LED

**Lamp type**  
 8x led 467lm CRI80 max. 3,8W  -  350mA

**Dimensions**  
 L1400xB45xH70  38

Ref	
2945.1400.1M	NW   WW
2945.1400.2M	NW   WW
2945.1400.47	NW   WW

**built-up**  
 500mA - 5,8W - 570 lm on request | other dimensions on request  
 500mA - 5,8W - 570 lm auf Anfrage | andere Abmessungen auf Anfrage  
 other dimming methods possible on request  
 andere Dimmtechniken auf Anfrage möglich



2921.1000/.. - STELLA LINE

~230V  IP20  0,5 m  



down - profile with 2x2 STELLA orientable + 1x2 ZIA LED fixed  
- with LED driver  
down - Profil mit 2x2 STELLA orientierbar + 1x2 ZIA LED fest  
- mit Driver LED

**Lamp type**  
 6x led 467lm CRI80 max. 3,8W  -  350mA

**Dimensions**  
 L1000xB45xH70  38

Ref	
2921.1000.1M	NW   WW
2921.1000.2M	NW   WW
2921.1000.47	NW   WW

**built-up**  
 500mA - 5,8W - 570 lm on request | other dimensions on request  
 500mA - 5,8W - 570 lm auf Anfrage | andere Abmessungen auf Anfrage  
 other dimming methods possible on request  
 andere Dimmtechniken auf Anfrage möglich



2922.1000/.. - STELLA LINE

~230V   IP20    0,5 m  05.20.50 





down - profile with 2x2 STELLA orientable + 1x3 ZIA LED fixed  
 - with LED driver  
 down - Profil mit 2x2 STELLA schwenkbar + 1x3 ZIA LED fest  
 - mit Driver LED

Lamp type

 7x led 467lm CRI80 max. 3,8W  -  350mA

Dimensions

 L1000xB45xH70  38

Ref

2922.1000.1M	NW   WW
2922.1000.2M	NW   WW
2922.1000.47	NW   WW

built-up

500mA - 5,8W - 570 lm on request | other dimensions on request  
 500mA - 5,8W - 570 lm auf Anfrage | andere Abmessungen auf Anfrage  
 other dimming methods possible on request  
 andere Dimmtechniken auf Anfrage möglich



2923.1400/.. - STELLA LINE

~230V   IP20    4,1800  0,5 m  05.20.50 



down - profile with 2x3 STELLA orientable + 1x3 ZIA LED fixed  
 - with LED driver  
 down - Profil mit 2x3 STELLA schwenkbar + 1x3 ZIA LED fest  
 - mit Driver LED

Lamp type

 9x led 467lm CRI80 max. 3,8W  -  350mA

Dimensions

 L1400xB45xH70  38

Ref

2923.1400.1M	NW   WW
2923.1400.2M	NW   WW
2923.1400.47	NW   WW

built-up

500mA - 5,8W - 570 lm on request | other dimensions on request  
 500mA - 5,8W - 570 lm auf Anfrage | andere Abmessungen auf Anfrage  
 other dimming methods possible on request  
 andere Dimmtechniken auf Anfrage möglich







28..LED/.. - BUTTERFLY LED

~230V   IP20    1,5 m  0,5 m  



lighting system - with led  
Lichtsystem - mit Led

Reference	Colours	Length	LED	Type of lamp
2800LED	1M   40	1100	NW	4x led 750lm max. 9W / 230V
2801LED	1M   40	1400	NW	6x led 750lm max. 9W / 230V
2802LED	1M   40	1700	NW	8x led 750lm max. 9W / 230V
2803LED	1M   40	2000	NW	10x led 750lm max. 9W / 230V

**built-up**  
dimmable phase-cut  
dimmbar Phasenabschnitt

280.LED/.. - BUTTERFLY LED

~230V   IP20    1,5 m  0,5 m  



lighting system - with led  
Lichtsystem - mit Led

Reference	Colours	Length	LED	Type of lamp
2804LED	1M   40	1100	NW	4x led 750lm max. 9W / 230V
2805LED	1M   40	1400	NW	6x led 750lm max. 9W / 230V
2806LED	1M   40	1700	NW	8x led 750lm max. 9W / 230V
2807LED	1M   40	2000	NW	10x led 750lm max. 9W / 230V

**built-up**  
dimmable phase-cut  
dimmbar Phasenabschnitt





2548BLED/.. - CLIP LED

~230V  IP20    1,5 m   

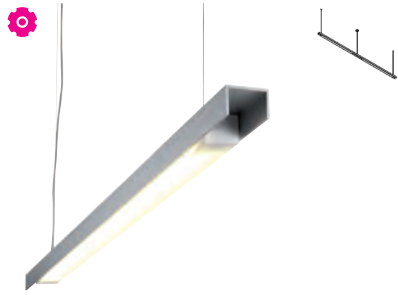

lighting system - PC 2 x 1200mm  
Lichtsystem - PC 2 x 1200mm

**Lamptype**  
8x led 750lm max. 9W  230V

**Dimensions**  
L3000xB60xH50

**Materials**  
aluminium 1M | 40

**Ref cat (LONG)**  
2548BLED.1M.NW white tex  
2548BLED.40.NW anodised alu

*built-up  
dimmable phase-cut  
dimmbar Phasenabschnitt*

2558CLED/.. - CLIP LED

~230V  IP20    1,5 m   

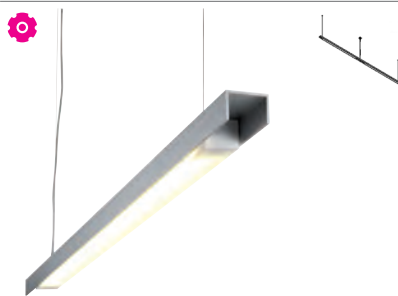

lighting system - PC 2 x 1500mm  
Lichtsystem - PC 2 x 1500mm

**Lamptype**  
10x led 750lm max. 9W  230V

**Dimensions**  
L3600xB60xH50

**Materials**  
aluminium 1M | 40

**Ref cat (LONG)**  
2558CLED.1M.NW white tex  
2558CLED.40.NW anodised alu

*built-up  
dimmable phase-cut  
dimmbar Phasenabschnitt*

2516BLED/.. - CLIP LED

~230V  IP20    1,5 m   

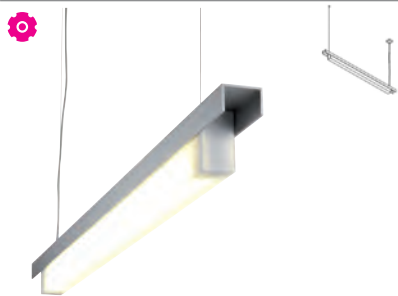

lighting system - PC 1200mm  
Lichtsystem - PC 1200mm

**Lamptype**  
4x led 750lm max. 9W  230V

**Dimensions**  
L1400xB60xH95

**Materials**  
aluminium 1M | 40

**Ref**  
2516BLED.1M.NW white tex  
2516BLED.40.NW anodised alu

*built-up  
dimmable phase-cut  
dimmbar Phasenabschnitt*

2520CLED/.. - CLIP LED

~230V  IP20    1,5 m   

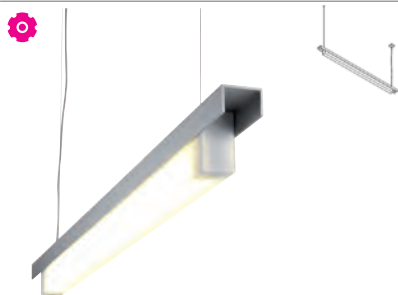

lighting system - PC 1500mm  
Lichtsystem - PC 1500mm

**Lamptype**  
5x led 1500lm max. 16W  230V

**Dimensions**  
L1700xB60xH95

**Materials**  
aluminium 1M | 40

**Ref cat (LONG)**  
2520CLED.1M.NW white tex  
2520CLED.40.NW anodised alu

*built-up  
dimmable phase-cut  
dimmbar Phasenabschnitt*

2524BLED/.. - CLIP LED

~230V  IP20  1,5 m   



lighting system - PC 2 x 1200mm  
Lichtsystem - PC 2 x 1200mm

<b>Lamptype</b>	8x led 750lm max. 9W 	230V
<b>Dimensions</b>	L2660xB60xH95	
<b>Materials</b>	aluminium	
		1M   40

<b>Ref cat (LONG)</b>	2524BLED.1M.NW	white tex
	2524BLED.40.NW	anodised alu

*built-up*  
dimmable phase-cut  
dimmbar Phasenabschnitt

2528CLED/.. - CLIP LED

~230V  IP20  1,5 m   



lighting system - PC 2 x 1500mm  
Lichtsystem - PC 2 x 1500mm

<b>Lamptype</b>	10x led 750lm max. 9W 	230V
<b>Dimensions</b>	L3260xB60xH95	
<b>Materials</b>	aluminium	
		1M   40

<b>Ref cat (LONG)</b>	2528CLED.1M.NW	white tex
	2528CLED.40.NW	anodised alu

*built-up*  
dimmable phase-cut  
dimmbar Phasenabschnitt



**2538.ALED/.. - CLIP DOUBLE**

~230V  IP20    1,5 m   

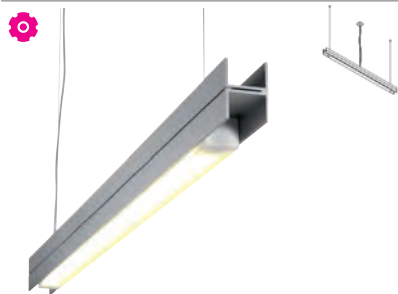

lighting system - down/up - PC 1200mm  
Lichtsystem - down/up - PC 1200mm

**Lamp type**  
8x led 750lm max. 9W  **230V**

**Dimensions**  
L1400xB60xH92

**Materials**  
aluminium **1M | 2M | 40**

**Ref**  
2538.ALED.1M.NW white tex  
2538.ALED.2M.NW black tex  
2538.ALED.40.NW anodised alu

**built-up**  
dimmable phase-cut - UP/DOWN  
dimmbar Phasenabschnitt

**2546.CLED/.. - CLIP DOUBLE**

~230V  IP20    1,5 m   

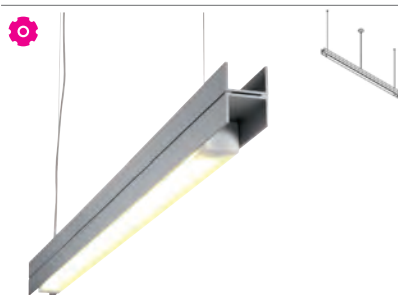

lighting system - down/up - PC 1500mm  
Lichtsystem - down/up - PC 1500mm

**Lamp type**  
10x led 750lm max. 9W  **230V**

**Dimensions**  
L1700xB60xH92

**Materials**  
aluminium **1M | 2M | 40**

**Ref cat (LONG)**  
2546.CLED.1M white tex  
2546.CLED.2M black tex  
2546.CLED.40 anodised alu

**built-up**  
dimmable phase-cut  
dimmbar Phasenabschnitt - UP/DOWN

**2554.BLED/.. - CLIP DOUBLE**

~230V  IP20    1,5 m   

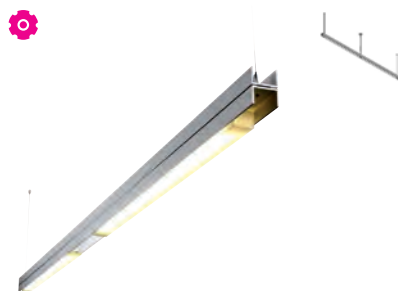

lighting system - down/up - PC 2 x 1200mm  
Lichtsystem - down/up - PC 2 x 1200mm

**Lamp type**  
16x led 750lm max. 9W  **230V**

**Dimensions**  
L2660xB60xH92

**Materials**  
aluminium **1M | 2M | 40**

**Ref cat (LONG)**  
2554.BLED.1M.NW white tex  
2554.BLED.2M.NW black tex  
2554.BLED.40.NW anodised alu

**built-up**  
dimmable phase-cut - UP/DOWN  
dimmbar Phasenabschnitt







2595/.. - LINEA

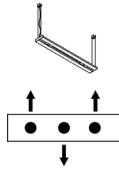

~230V    IP20    1,5 m  9,2050  0,5 m  05.20.50 



lighting system - down/up - current supply sidelong - with transformer - with electronic gear  
 Lichtsystem - down/up - laterale Stromzuführung - mit Trafo - mit elektronischem Vorschaltgerät

Ref	
2595.1M	white tex
2595.2M	black tex
2595.40	anodised alu

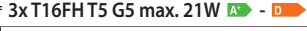
**Lamp type**

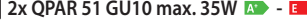
 3x T16FH T5 G5 max. 21W 	230V
 2x QPAR 51 GU10 max. 35W 	230V

**Dimensions**  
 L1600xB220xH50

**Materials**  
 aluminium 1M | 2M | 40

built-up

2596/.. - LINEA

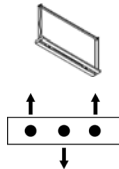

~230V    IP20    1,5 m  11,0000  0,5 m  05.20.50 



lighting system - down/up - current supply to choose - with transformer - with electronic gear  
 Lichtsystem - down/up - Stromzuführung auf Wahl - mit Trafo - mit elektronischem Vorschaltgerät

Ref	
2596.1M	white tex
2596.2M	black tex
2596.40	anodised alu

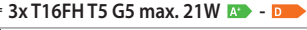
**Lamp type**

 3x T16FH T5 G5 max. 21W 	230V
 2x QPAR 51 GU10 max. 35W 	230V

**Dimensions**  
 L1600xB220xH50

**Materials**  
 aluminium 1M | 2M | 40

built-up  
 standard with ceiling beam  
 standard mit Deckenbalken

2597/.. - LINEA



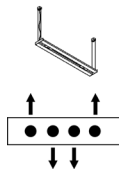

~230V    IP20    1,5 m  9,2500  0,5 m  05.20.50 



lighting system - down/up - current supply sidelong - with transformer - with electronic gear  
 Lichtsystem - down/up - laterale Stromzuführung - mit Trafo - mit elektronischem Vorschaltgerät

Ref	
2597.1M	white tex
2597.2M	black tex
2597.40	anodised alu

**Lamp type**

 4x T16FH T5 G5 max. 21W 	230V
 2x QPAR 51 GU10 max. 35W 	230V

**Dimensions**  
 L1600xB220xH50

**Materials**  
 aluminium 1M | 2M | 40

built-up

2598/.. - LINEA



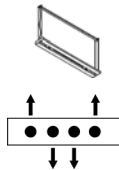

~230V    IP20    1,5 m  9,2500  0,5 m  05.20.50 



lighting system - down/up - current supply to choose - with transformer - with electronic gear  
 Lichtsystem - down/up - Stromzuführung auf Wahl - mit Trafo - mit elektronischem Vorschaltgerät

Ref	
2598.1M	white tex
2598.2M	black tex
2598.40	anodised alu

**Lamp type**

 4x T16FH T5 G5 max. 21W 	230V
 2x QPAR 51 GU10 max. 35W 	230V

**Dimensions**  
 L1600xB220xH50

**Materials**  
 aluminium 1M | 2M | 40

built-up  
 standard with ceiling beam  
 standard mit Deckenbalken

**2100ALED/.. - METRO LED**

~230V  IP20    0 m   



lighting system - 5 openings  
Lichtsystem - 5 Löcher

**Lamptype**  
2x led 750lm max. 9W  **230V**

**Dimensions**  
Ø100xL1100

**Materials**  
aluminium **1M | 2M | 40**

**Ref**  
2100ALED.1M.NW white tex  
2100ALED.2M.NW black tex  
2100ALED.40.NW anodised alu

*built-up*  
*dimmable phase-cut*  
*dimmbar Phasenabschnitt*

**2101ALED/.. - METRO LED**

~230V  IP20    1,5 m   



lighting system - 7 openings  
Lichtsystem - 7 Löcher

**Lamptype**  
3x led 750lm max. 9W  **230V**

**Dimensions**  
Ø100xL1400

**Materials**  
aluminium **1M | 2M | 40**

**Ref**  
2101ALED.1M.NW white tex  
2101ALED.2M.NW black tex  
2101ALED.40.NW anodised alu

*built-up*  
*dimmable phase-cut*  
*dimmbar Phasenabschnitt*

**2102ALED/.. - METRO LED**

~230V  IP20    1,5 m   



lighting system - 9 openings  
Lichtsystem - 9 Löcher

**Lamptype**  
4x led 750lm max. 9W  **230V**

**Dimensions**  
Ø100xL1700

**Materials**  
aluminium **1M | 2M | 40**

**Ref cat (LONG)**  
2102ALED.1M.NW white tex  
2102ALED.2M.NW black tex  
2102ALED.40.NW anodised alu

*built-up*  
*dimmable phase-cut*  
*dimmbar Phasenabschnitt*

**2103ALED/.. - METRO LED**

~230V  IP20    1,5 m   



lighting system - 12 openings  
Lichtsystem - 12 Löcher

**Lamptype**  
5x led 750lm max. 9W  **230V**

**Dimensions**  
Ø100xL2100

**Materials**  
aluminium **1M | 2M | 40**

**Ref cat (LONG)**  
2103ALED.1M.NW white tex  
2103ALED.2M.NW black tex  
2103ALED.40.NW anodised alu

*built-up*  
*dimmable phase-cut*  
*dimmbar Phasenabschnitt*

2106ALED/.. - METRO LED

~230V



IP20



0 m



0.5 m



lighting system - 3 openings  
Lichtsystem - 3 Löcher

Lamp type

2x led 750lm max. 9W A+ 230V

4x QPAR 51 GU10 max. 35W A+ - E 230V

Dimensions

Ø100xL1400

Materials

aluminium 1M | 2M | 40

Ref

2106ALED.1M.NW white tex

2106ALED.2M.NW black tex

2106ALED.40.NW anodised alu

**built-up**

4 step spotlights included - dimmable phase-cut

4 Strahler Step einbegriffen - dimmbar

Phasenabschnitt



2601/.. - MIKADO

~230V   IP20    1,5 m  2,0800  0,5 m  05.20.50 

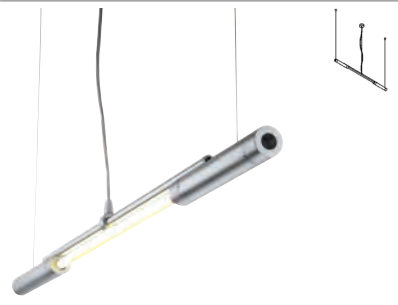

lighting system - lamp not covered - with electronic gear  
 Lichtsystem - Leuchtmittel nicht abgedeckt - mit elektronischem Vorschaltgerät

**Lamp type**  
 1x T16FQ T5 G5 max. 24W  230V

**Dimensions**  
 Ø35xL1004

**Materials**  
 aluminium 14 | 1M | 2M

Ref	
2601.1M	white tex
2601.2M	black tex
2601.14	alu satin

**built-up**  
 without ceiling plate - with base 005 + 3 suspensions  
 ohne Deckenplatte - mit Rosette 005 + 3 Abhängungen

2602/.. - MIKADO

~230V   IP20    1,5 m  3,7000  0,5 m  05.20.50 



lighting system - lamp not covered - with electronic gear  
 Lichtsystem - Leuchtmittel nicht abgedeckt - mit elektronischem Vorschaltgerät

**Lamp type**  
 2x T16FQ T5 G5 max. 24W  230V

**Dimensions**  
 Ø35xL1764

**Materials**  
 aluminium 14 | 1M | 2M

Ref cat (LONG)	
2602.1M	white tex
2602.2M	black tex
2602.14	alu satin

**built-up**  
 without ceiling plate - with base 005 + 3 suspensions  
 ohne Deckenplatte - mit Rosette 005 + 3 Abhängungen

2603/.. - MIKADO

~230V   IP20    1,5 m  4,5800  0,5 m  05.20.50 



lighting system - lamp not covered - with electronic gear  
 Lichtsystem - Leuchtmittel nicht abgedeckt - mit elektronischem Vorschaltgerät

**Lamp type**  
 3x T16FQ T5 G5 max. 24W  230V

**Dimensions**  
 Ø35xL2524

**Materials**  
 aluminium 14 | 1M | 2M

Ref cat (LONG)	
2603.1M	white tex
2603.2M	black tex
2603.14	alu satin

**built-up**  
 without ceiling plate - with base 005 + 4 suspensions  
 ohne Deckenplatte - mit Rosette 005 + 4 Abhängungen

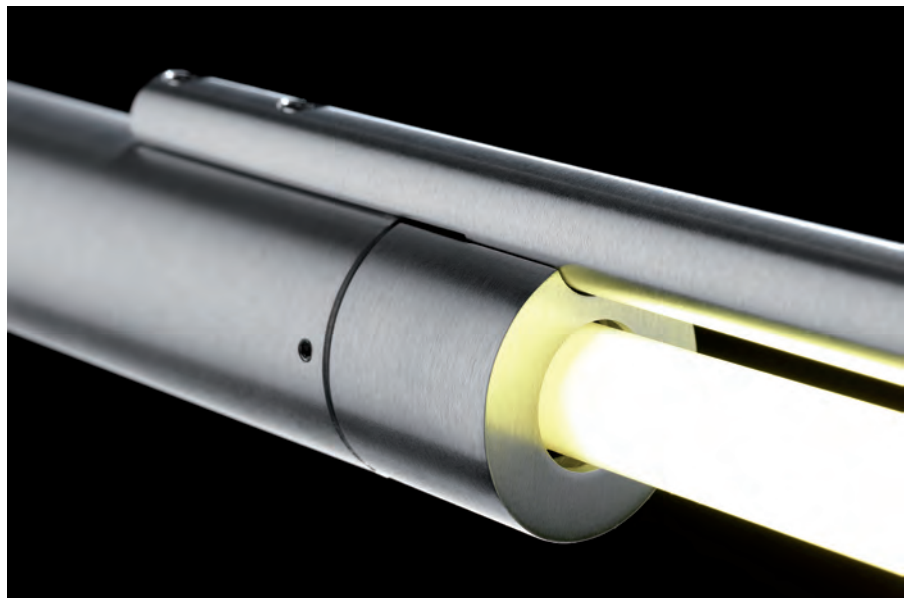



# INDOOR SYSTEM UP

# Index

## S

STILETTO	521-551
FIXATION BOX 45X45	521-527
FIXATION BOX 70X45	529-531
FIXATION BOX 60X60	532-534
BOX / SPOTS	535-545
PROFILES	547-548
CORNERS	549
SPACER	526
CABLES	551
MODULES TIMES	553-554
STILETTO- TIMES 45X45	555
STILETTO- TIMES 45X70	556

# Stiletto configurator

Sketching with pen and paper is a thing of the past from now on. Psmighting developed a configurator with which you can create your own Stiletto system. **Add, create, modify...** Give free rein to your creativity. Furthermore, via the configurator you can **quickly and easily request a quote** for your personalised Stiletto.

You can find the configurator on our website [www.psmighting.be](http://www.psmighting.be) or go to **[stiletto.psmighting.be](http://stiletto.psmighting.be)**.

Skizzen mit Stift und Papier gehören von nun an der Vergangenheit an. Psmighting hat einen Konfigurator entwickelt, mit dem Sie Ihr eigenes Stiletto-System erstellen können. **Hinzufügen, kreieren, anpassen...** Lassen Sie Ihrer Kreativität freien Lauf. Darüber hinaus ermöglicht Ihnen der Konfigurator, **schnell und einfach ein Angebot** für Ihr personalisiertes Stiletto anzufordern.

Sie finden den Konfigurator auf unserer Website [www.psmighting.be](http://www.psmighting.be) oder unter **[stiletto.psmighting.be](http://stiletto.psmighting.be)**.



# Stiletto.

add on and on and.







8201/.. - STILETTO

IP20   0,2100 



Junction box for spot or pendant with 1 input  
Anschlußbox für Strahler oder Pendelleuchte mit 1 Eingang

**Dimensions**

↳ L45xB45xH45

**Materials**

aluminium 14 | 1M | 2M | 45

**Ref**

8201.1M	white tex
8201.2M	black tex
8201.14	alu satin
8201.45	sun gold

8202/.. - STILETTO

IP20   0,1500 



Junction box for spot or pendant with 2 inputs  
Anschlußbox für Strahler oder Pendelleuchte mit 2 Eingängen

**Dimensions**

↳ L45xB45xH45

**Materials**

aluminium 14 | 1M | 2M | 45

**Ref**

8202.1M	white tex
8202.2M	black tex
8202.14	alu satin
8202.45	sun gold

I-connector  
I-Verbinder

8203/.. - STILETTO

IP20   0,2500 



Junction box for spot or pendant with 3 inputs  
Anschlußbox für Strahler oder Pendelleuchte mit 3 Eingängen

**Dimensions**

↳ L45xB45xH45

**Materials**

aluminium 14 | 1M | 2M | 45

**Ref**

8203.1M	white tex
8203.2M	black tex
8203.14	alu satin
8203.45	sun gold

T-connector  
T-Verbinder

8204/.. - STILETTO

IP20  



Junction box for spot or pendant with 4 inputs  
Anschlußbox für Strahler oder Pendelleuchte mit 4 Eingängen

**Dimensions**

↳ L45xB45xH45

**Materials**

aluminium 14 | 1M | 2M | 45

**Ref**

8204.1M	white tex
8204.2M	black tex
8204.14	alu satin
8204.45	sun gold

X-connector  
X-Verbinder

8208/.. - STILETTO

IP20   0.2200 



Junction box for spot or pendant with 2 inputs  
Anschlußbox für Strahler oder Pendelleuchte mit 2  
Eingängen

**Dimensions**

↳ L45xB45xH45

**Materials**

aluminium 14 | 1M | 2M | 45

**Ref**

8208.1M	white tex
8208.2M	black tex
8208.14	alu satin
8208.45	sun gold

8209/.. - STILETTO

IP20  



Junction box for spot or pendant with 1 diagonal input  
Anschlußbox für Strahler oder Pendelleuchte mit 1 schräger  
Eingang

**Dimensions**

↳ L45xB45xH45

**Materials**

aluminium 14 | 1M | 2M | 45

**Ref**

8209.1M	white tex
8209.2M	black tex
8209.14	alu satin
8209.45	sun gold

8210/.. - STILETTO

IP20  



Junction box for spot or pendant with 2 diagonal inputs  
Anschlußdose für Strahler oder Pendelleuchte mit 2  
Diagonaleingängen

**Dimensions**

↳ L45xB45xH45

**Materials**

aluminium 14 | 1M | 2M | 45

**Ref**

8210.1M	white tex
8210.2M	black tex
8210.14	alu satin
8210.45	sun gold

8222/.. - STILETTO

 IP20  



Junction box for spot or pendant with 2 diagonal inputs and  
1 straight input  
Anschlußdose für Strahler oder Pendelleuchte mit 2  
Diagonaleingängen und 1 Rechte

**Dimensions**

↳ L45xB45xH45

**Materials**

aluminium 14 | 1M | 2M | 45

**Ref**

8222.1M	white tex
8222.2M	black tex
8222.14	alu satin
8222.45	sun gold

8223/.. - STILETTO

IP20  

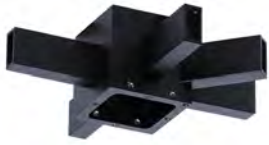

Junction box for spot or pendant with 4 straight inputs and 1 diagonal input  
 Anschlußdose für Strahler oder Pendelleuchte mit 4 rechte Eingängen und 1 Diagonaleingang

**Dimensions**

↔ L45xB45xH45

**Materials**

aluminium

**Ref**

8223.1M

8223.2M

8223.14

8223.45

white tex

black tex

alu satin

sun gold

14 | 1M | 2M | 45





8205/.. - STILETTO

IP20   0,1000 



blind coverplate  
Blindabdeckungsplatte

**Dimensions**

↔ L48xB48xH8

**Materials**

aluminium 14 | 1M | 2M | 45  
brass 4 | 16

**Ref**

8205.1M	white tex
8205.2M	black tex
8205.4	shiny gold
8205.14	alu satin
8205.16	satin gold
8205.45	sun gold

8206/.. - STILETTO - 10,2

IP20   0,1000 

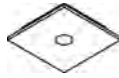

Coverplate for spot or pendant  
Abdeckplatte für Strahler oder Pendelleuchte

**Dimensions**

↔ L48xB48xH8

**Options**

P039 - STRAIN RELIEF - TREKONTLASTING  
P040 - STRAIN RELIEF - TREKONTLASTING

**Materials**

aluminium 14 | 1M | 2M | 45  
brass 4 | 16

**Ref**

8206.1M	white tex
8206.2M	black tex
8206.4	shiny gold
8206.14	alu satin
8206.16	satin gold
8206.45	sun gold

8207/.. - STILETTO - B3

IP20   0,1300 



Coverplate for pendant with swivel B3  
Abdeckplatte für Pendelleuchte mit swivel B3

**Dimensions**

↔ L48xB48xH8

**Materials**

aluminium 14 | 1M | 2M | 45  
brass 4 | 16

**Ref**

8207.1M	white tex
8207.2M	black tex
8207.4	shiny gold
8207.14	alu satin
8207.16	satin gold
8207.45	sun gold

8200/.. - STILETTO

=350mA



spotlight - Coverplate with zialed - without LED driver  
 Aufbaustrahler - Abdeckungsplatte mit zialed - ohne Driver LED

Lamptype

1x led 467lm CRI80 max. 3,8W A+ - A+ 350mA

Dimensions

L48xB48xH32 48° reflector

Ref

8200.1M	NW   WW
8200.2M	NW   WW
8200.4	NW   WW
8200.14	NW   WW
8200.16	NW   WW
8200.45	NW   WW

built-up

8261/.. - STILETTO

=350mA



spotlight - square - fixed - Coverplate with zialed - without LED driver  
 Aufbaustrahler - viereckig - fest - Abdeckungsplatte mit zialed - ohne Driver LED

Lamptype

1x led 467lm CRI80 max. 3,8W A+ - A+ 350mA

Dimensions

L48xB48xH32 48° reflector

Ref

8261.1M	NW   WW
8261.2M	NW   WW
8261.4	NW   WW
8261.14	NW   WW
8261.16	NW   WW
8261.45	NW   WW

built-up



SYSTEM UP

8095/.. - STILETTO

IP20  

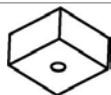

**Materials**  
aluminium

1M | 2M

**Ref**

8095.1M  
8095.2M

white tex  
black tex

8096/.. - STILETTO

IP20  



**Materials**  
aluminium

1M | 2M

**Ref**

8096.1M  
8096.2M

white tex  
black tex

8097/.. - STILETTO

IP20  



**Materials**  
aluminium

1M | 2M

**Ref**

8097.1M  
8097.2M

white tex  
black tex

8098/.. - STILETTO

IP20  



**Materials**  
aluminium

1M | 2M

**Ref**

8098.1M  
8098.2M

white tex  
black tex

8224/.. - STILETTO

IP20    



square - fixed - Coverplate for vertical profile  
viereckig - fest - Abdeckplatte für vertikales Profil

**Dimensions**

← L48xB48xH8

**Materials**

aluminium 1M | 2M | 45  
brass 4 | 16

**Ref**

8224.1M	white tex
8224.2M	black tex
8224.4	shiny gold
8224.16	satin gold
8224.45	sun gold

built-up

8281/.. - STILETTO

IP20  



Cover plate with closed hook for suspension  
Abdeckplatte mit geschlossenem Haken für Pendel

**Materials**

aluminium 1M | 2M  
brass 16

**Ref**

8281.1M	white tex
8281.2M	black tex
8281.16	satin gold

SYSTEM UP





**P039/.. - STRAIN RELIEF - TREKONTLASTING**

IP20    



strain relief  
Zugentlastung

**Dimensions**

↔ Ø15xH21

**Materials**

aluminium	1   2   11   14   1M   21   2M   44   46   53
brass	4   13   16   23
red copper	28

**Ref**

P039.1	white
P039.1M	white tex
P039.2	black
P039.2M	black tex
P039.4	shiny gold
P039.11	alu grey
P039.13	bronze
P039.14	alu satin
P039.16	satin gold
P039.21	rust
P039.23	dark bronze
P039.28	rosé
P039.44	anthracite grey
P039.46	grey-brown
P039.53	bronze-brown

to be fixed to rosette or ceiling light  
für Montage auf Rosette oder Deckenleuchte

SYSTEM UP

**P040/.. - STRAIN RELIEF - TREKONTLASTING**

IP20    



strain relief  
Zugentlastung

**Dimensions**

↔ Ø15xH21

**Materials**

aluminium	1   2   11   14   1M   2M
brass	4   13   16   23
red copper	28

**Ref**

P040.1	white
P040.1M	white tex
P040.2	black
P040.2M	black tex
P040.4	shiny gold
P040.11	alu grey
P040.13	bronze
P040.14	alu satin
P040.16	satin gold
P040.23	dark bronze
P040.28	rosé

to be fixed to rosette or ceiling light  
für Montage auf Rosette oder Deckenleuchte

8211/.. - STILETTO

IP20  



Junction box for spot or pendant with 1 input  
Anschlußbox für Strahler oder Pendelleuchte mit 1 Eingang

**Dimensions**

↳ L70xB45xH45

**Materials**

aluminium 14 | 1M | 2M | 45

**Ref**

8211.1M	white tex
8211.2M	black tex
8211.14	alu satin
8211.45	sun gold

I-connector  
I-Verbinder

8212/.. - STILETTO

IP20   



Junction box for spot or pendant with 2 inputs  
Anschlußbox für Strahler oder Pendelleuchte mit 2 Eingängen

**Dimensions**

↳ L70xB45xH45

**Materials**

aluminium 14 | 1M | 2M | 45

**Ref**

8212.1M	white tex
8212.2M	black tex
8212.14	alu satin
8212.45	sun gold

T-connector  
T-Verbinder

8213/.. - STILETTO

IP20  



Junction box for spot or pendant with 3 inputs  
Anschlußbox für Strahler oder Pendelleuchte mit 3 Eingängen

**Dimensions**

↳ L70xB45xH45

**Materials**

aluminium 14 | 1M | 2M | 45

**Ref**

8213.1M	white tex
8213.2M	black tex
8213.14	alu satin
8213.45	sun gold

T-connector  
T-Verbinder

8214/.. - STILETTO

IP20  



Junction box for spot or pendant with 4 inputs  
Anschlußbox für Strahler oder Pendelleuchte mit 4 Eingängen

**Dimensions**

↳ L70xB45xH45

**Materials**

aluminium 14 | 1M | 2M | 45

**Ref**

8214.1M	white tex
8214.2M	black tex
8214.14	alu satin
8214.45	sun gold

X-connector  
X-Verbinder

8215/.. - STILETTO

IP20  



blind coverplate  
Blindabdeckungsplatte

**Dimensions**

↔ L73xB48xH8

**Materials**

aluminium 14 | 1M | 2M | 45  
brass 4 | 16

**Ref**

8215.1M	white tex
8215.2M	black tex
8215.4	shiny gold
8215.14	alu satin
8215.16	satin gold
8215.45	sun gold

8216/.. - STILETTO - 10,2

IP20   



Coverplate for spot or pendant  
Abdeckplatte für Strahler oder Pendelleuchte

**Dimensions**

↔ L73xB48xH8

**Options**

P039 - STRAIN RELIEF - TREKONTLASTING  
P040 - STRAIN RELIEF - TREKONTLASTING

**Materials**

aluminium 14 | 1M | 2M | 45  
brass 4 | 16

**Ref**

8216.1M	white tex
8216.2M	black tex
8216.4	shiny gold
8216.14	alu satin
8216.16	satin gold
8216.45	sun gold

spots to be ordered separately  
Strahler separat zu bestellen

8217/.. - STILETTO - B3

IP20  



Coverplate for pendant with swivel B3  
Abdeckplatte für Pendelleuchte mit swivel B3

**Dimensions**

↔ L73xB48xH8

**Materials**

aluminium 14 | 1M | 2M | 45  
brass 4 | 16

**Ref**

8217.1M	white tex
8217.2M	black tex
8217.4	shiny gold
8217.14	alu satin
8217.16	satin gold
8217.45	sun gold

pendant to be ordered separately  
Pendelleuchte separat zu bestellen

8218/.. - STILETTO

=350mA

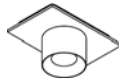

spotlight - Coverplate with zialed - without LED driver  
 Aufbaustrahler - Abdeckungsplatte mit zialed - ohne Driver LED

Lamp type

1x led 467lm CRI80 max. 3,8W A+ - A+ 350mA

Dimensions

L73xB48xH32  $\wedge$  48° reflector

Ref

8218.1M	NW   WW
8218.2M	NW   WW
8218.4	NW   WW
8218.14	NW   WW
8218.16	NW   WW
8218.45	NW   WW

built-up

8272/.. - STILETTO

=350mA



spotlight - square - fixed - Coverplate with zialed - without LED driver  
 Aufbaustrahler - viereckig - fest - Abdeckungsplatte mit zialed - ohne Driver LED

Lamp type

1x led 467lm CRI80 max. 3,8W A+ - A+ 350mA

Dimensions

L73xB48xH32  $\wedge$  48° reflector

Ref

8272.1M	NW   WW
8272.2M	NW   WW
8272.4	NW   WW
8272.14	NW   WW
8272.16	NW   WW
8272.45	NW   WW

built-up

8225/.. - STILETTO



downlight - square - Coverplate for vertical profile  
 Einbaustrahler - viereckig - Abdeckplatte für vertikales Profil

Dimensions

L73xB48xH8

Materials

aluminium 1M | 2M | 45  
 brass 4 | 16

Ref

8225.1M	white tex
8225.2M	black tex
8225.4	shiny gold
8225.16	satin gold
8225.45	sun gold



8294/.. - STILETTO

IP20  



Junction box for spot or pendant with 4 straight inputs  
Anschlußbox für Strahler oder Pendelleuchte mit 4 rechte Eingängen

**Dimensions**

↳ L60xB60xH45

**Materials**

aluminium 14 | 1M | 2M | 45

**Ref**

8294.1M	white tex
8294.2M	black tex
8294.14	alu satin
8294.45	sun gold

X-connector  
X-Verbinder

8295/.. - STILETTO

IP20  



Junction box for spot or pendant with 4 diagonal inputs  
Anschlußbox für Strahler oder Pendelleuchte mit 4 Diagonaleingängen

**Dimensions**

↳ L60xB60xH45

**Materials**

aluminium 14 | 1M | 2M | 45

**Ref**

8295.1M	white tex
8295.2M	black tex
8295.14	alu satin
8295.45	sun gold

X-connector  
X-Verbinder



8296/.. - STILETTO

IP20  



blind coverplate  
Blindabdeckungsplatte

**Dimensions**

↔ L63xB63xH8

**Materials**

aluminium 14 | 1M | 2M | 45  
brass 4 | 16

**Ref**

8296.1M	white tex
8296.2M	black tex
8296.4	shiny gold
8296.14	alu satin
8296.16	satin gold
8296.45	sun gold

8297/.. - STILETTO - 10,2

IP20  

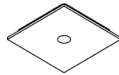

Coverplate for spot or pendant  
Abdeckplatte für Strahler oder Pendelleuchte

**Dimensions**

↔ L63xB63xH8

**Options**

P039 - STRAIN RELIEF - TREKONTLASTING  
P040 - STRAIN RELIEF - TREKONTLASTING

**Materials**

aluminium 14 | 1M | 2M | 45  
brass 4 | 16

**Ref**

8297.1M	white tex
8297.2M	black tex
8297.4	shiny gold
8297.14	alu satin
8297.16	satin gold
8297.45	sun gold

8298/.. - STILETTO - B3

IP20  

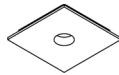

Coverplate for pendant with swivel B3  
Abdeckplatte für Pendelleuchte mit swivel B3

**Dimensions**

↔ L63xB63xH8

**Materials**

aluminium 14 | 1M | 2M | 45  
brass 4 | 16

**Ref**

8298.1M	white tex
8298.2M	black tex
8298.4	shiny gold
8298.14	alu satin
8298.16	satin gold
8298.45	sun gold

8299/.. - STILETTO

=350mA



spotlight - Coverplate with zialed - without LED driver  
 Aufbaustrahler - Abdeckungsplatte mit zialed - ohne Driver LED

Lamp type

1x led 467lm CRI80 max. 3,8W A+ - A+ 350mA

Dimensions

L63xB63xH32 48° reflector

Ref

8299.1M	NW   WW
8299.2M	NW   WW
8299.4	NW   WW
8299.14	NW   WW
8299.16	NW   WW
8299.45	NW   WW

built-up  
 serial connection  
 Serieschaltung

8289/.. - STILETTO

=350mA



square - fixed - without LED driver  
 viereckig - fest - ohne Driver LED

Lamp type

1x led 467lm CRI80 max. 3,8W A+ - A+ 350mA

Dimensions

L63xB63xH32 48° reflector

Ref

8289.1M	NW   WW
8289.2M	NW   WW
8289.4	NW   WW
8289.14	NW   WW
8289.16	NW   WW
8289.45	NW   WW

built-up

8228/.. - STILETTO



None - Coverplate for vertical profile  
 Abdeckplatte für vertikales Profil

Materials

aluminium 1M | 2M | 45  
 brass 4 | 16

Ref

8228.1M	white tex
8228.2M	black tex
8228.4	shiny gold
8228.16	satin gold
8228.45	sun gold

8219/.. - STILETTO

IP20   

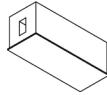

Junction box with blind coverplate  
Anschlußdose mit Blindabdeckungsplatte

**Dimensions**

←→ L123xB48xH47

**Options**

TR.127040 - DRIVER

**Materials**

aluminium 14 | 1M | 2M | 45  
brass 4 | 16

**Ref**

8219.1M	white tex
8219.2M	black tex
8219.4.2M	shiny gold
8219.14	alu satin
8219.16.2M	satin gold
8219.45	sun gold

room for driver  
Raum für Ledkonverter

8220/.. - STILETTO

IP20  

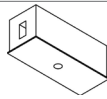

Junction box with coverplate for spotlight or pendant  
Anschlußdose mit Abdeckplatte für Strahler oder Pendelleuchte

**Dimensions**

←→ L123xB48xH47

**Options**

P039 - STRAIN RELIEF - TREKONTLASTING  
P040 - STRAIN RELIEF - TREKONTLASTING  
TR127040 - DRIVER

**Materials**

aluminium 14 | 1M | 2M | 45  
brass 4 | 16

**Ref**

8220.1M	white tex
8220.2M	black tex
8220.4.2M	shiny gold
8220.14	alu satin
8220.16.2M	satin gold
8220.45	sun gold

spotlight to order seperately  
Strahler separat bestellen





8221/.. - STILETTO - 10,2

~230V  IP20  0,5 m  



Connection box with Capa on tige 5cm  
Anschlussdose mit Capa auf Tige 5cm

Lamp type

1x QPAR 51 GU10 max. 20W  -  230V  
or 1x QPAR70 GU10 max. 7W 

Dimensions

L123xB48xH47

Materials

aluminium 14 | 1M | 2M | 45  
brass 4 | 16

Ref

8221.1M	white tex
8221.2M	black tex
8221.4.2M	shiny gold
8221.14	alu satin
8221.16.2M	satin gold
8221.45	sun gold

built-up  
lightbulb not included  
Leuchtmittel nicht einbegriffen

8229/.. - STILETTO - 10,2

~230V  IP20  0,5 m  



Junction box with Capa X spotlight on bar 5cm  
Anschlußdose mit Capa X Strahler auf Stange 5cm

Lamp type

1x QPAR 51 GU10 max. 20W  -  230V

Dimensions

L123xB48xH47

Materials

aluminium 14 | 1M | 2M | 45  
brass 4 | 16

Ref

8229.1M	white tex
8229.2M	black tex
8229.4.2M	shiny gold
8229.14	alu satin
8229.16.2M	satin gold
8229.45	sun gold

built-up  
lightbulb not included  
Leuchtmittel nicht einbegriffen



8226/.. - STILETTO

~230V   IP20  0,5 m  



Junction box with Jacob ledlight on bar 5cm - with LED driver  
Anschlußdose mit Jacob LED Strahler auf Stange 5cm - mit Driver LED

Lamp type

1x led 467lm CRI80 max. 3,8W  -  350mA

Dimensions

L123xB48xH47  $\wedge$  48° reflector

Ref

8226.1M	NW   WW
8226.2M	NW   WW
8226.4.2M	NW   WW
8226.14	NW   WW
8226.16.2M	NW   WW
8226.45.45	NW   WW

built-up

8230/.. - STILETTO

IP20  

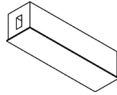

Junction box with blind coverplate  
Anschlußdose mit Blindabdeckungsplatte

**Dimensions**

↳ L183xB48xH47

**Options**

TR122246 - DRIVER

**Materials**

aluminium 14 | 1M | 2M | 4S  
brass 4 | 16

**Ref**

8230.1M	white tex
8230.2M	black tex
8230.4.2M	shiny gold
8230.14.2M	alu satin
8230.16	satin gold
8230.45	sun gold

room for driver  
Raum für Ledkonverter

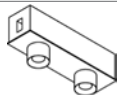

8232/.. - STILETTO

~230V   IP20     



round - Coverplate with 2 built-up spots ZiaLed M - with LED driver  
rund - Abdeckplatte mit 2 Aufbaustrahler ZiaLed M - mit Driver LED

**Lamp type**

⊙ 2x led 467lm CRI80 max. 3,8W  -  350mA

**Dimensions**

↳ L183xB48xH47 

**Ref**

8232.1M	NW   WW
8232.2M	NW   WW
8232.4.2M	NW   WW
8232.14	NW   WW
8232.16.2M	NW   WW
8232.45.45	NW   WW

built-up

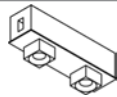

8107/.. - STILETTO

~230V   IP20    



square - Coverplate with 2 built-up spots ZiaLed M - with LED driver  
viereckig - Abdeckplatte mit 2 Aufbaustrahler ZiaLed M - mit Driver LED

**Lamp type**

⊙ 2x led 467lm CRI80 max. 3,8W  -  350mA

**Dimensions**

↳ L183xB48xH47 

**Ref**

8107.1M	NW   WW
8107.2M	NW   WW
8107.14	NW   WW
8107.16.1M	NW   WW
8107.16.2M	NW   WW
8107.45.45	NW   WW

built-up

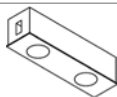

8108/.. - STILETTO

=350mA   IP20     



Coverplate with 2 built-in spots ZiaLed M - without LED driver  
Abdeckplatte mit 2 Einbaustrahler ZiaLed M - ohne Driver LED

**Lamp type**

⊙ 2x led 467lm CRI80 max. 3,8W  -  350mA

**Dimensions**

↳ L183xB48xH47 

**Ref**

8108.1M	NW   WW
8108.2M	NW   WW
8108.14	NW   WW
8108.29	NW   WW
8108.45	NW   WW
8108.49	NW   WW



built-up

8233/.. - STILETTO

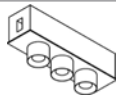
=350mA      



round - Junction box with 3 built-up spots ZiaLed M - with LED driver  
 rund - Anschlußdose mit 3 Aufbaustrahler ZiaLed M - mit Driver LED

**Lamp type**  
 3x led 467lm CRI80 max. 3,8W  -  350mA

**Dimensions**  
 L183xB48xH47 

Ref	
8233.1M	NW   WW
8233.2M	NW   WW
8233.4.2M	NW   WW
8233.14	NW   WW
8233.16.2M	NW   WW
8233.45.45	NW   WW

built-up

8109/.. - STILETTO

~230V     

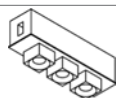

square - Junction box with 3 built-up spots ZiaLed M - with LED driver  
 viereckig - Anschlußdose mit 3 Aufbaustrahler ZiaLed M - mit Driver LED

**Lamp type**  
 3x led 467lm CRI80 max. 3,8W  -  350mA

**Dimensions**  
 L183xB48xH47 

Ref	
8109.1M	NW   WW
8109.2M	NW   WW
8109.14	NW   WW
8109.16.1M	NW   WW
8109.16.2M	NW   WW
8109.45.45	NW   WW



built-up

8116/.. - STILETTO

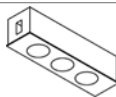
=350mA     



Junction box with 3x built-in spot ZiaLed M - without LED driver  
 Anschlußdose mit 3x Einbaustrahler ZiaLed M - ohne Driver LED

**Lamp type**  
 3x led 467lm CRI80 max. 3,8W  -  350mA

**Dimensions**  
 L183xB48xH47 

Ref	
8116.1M	NW   WW
8116.2M	NW   WW
8116.14	NW   WW
8116.29	NW   WW
8116.45	NW   WW
8116.49	NW   WW

built-up

8234/.. - STILETTO - 10,2

IP20 

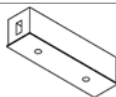

Junction box with coverplate for 2 built-up spotlights  
 Anschlußdose mit Abdeckplatte für 2 Aufbaustrahler auf Stange

**Dimensions**  
 L183xB48xH47

**Materials**  
 aluminium 14 | 1M | 2M | 45  
 brass 4 | 16

Ref	
8234.1M	white tex
8234.2M	black tex
8234.4.2M	shiny gold
8234.14	alu satin
8234.16.2M	satin gold
8234.45	sun gold

spots to be ordered separately  
 Strahler separat zu bestellen

8235/.. - STILETTO

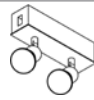

Junction box with 2x Capa spotlight on bar 5cm  
Anschlußdose mit 2x Capa Strahler auf Stange 5cm

Lamp type

2x QPAR 51 GU10 max. 20W A+ - E 230V  
or 2x QPAR70 GU10 max. 7W A+ 230V

Dimensions

L183xB48xH47

Materials

aluminium 14 | 1M | 2M | 45  
brass 4 | 16

~230V IP20 0,8700 0,5 m 05.20.02 CE

Ref

8235.1M	white tex
8235.2M	black tex
8235.4.2M	shiny gold
8235.14	alu satin
8235.16.2M	satin gold
8235.45	sun gold

built-up  
lightbulbs not included  
Leuchtmittel nicht einbegriffen

8231/.. - STILETTO

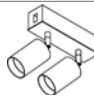

Junction box with 2x Capa X spotlight on bar 5cm  
Anschlußdose mit 2x Capa X Strahler auf Stange 5cm

Lamp type

2x QPAR 51 GU10 max. 20W A+ - E 230V

Dimensions

L183xB48xH47

Materials

aluminium 14 | 1M | 2M | 45  
brass 4 | 16

~230V IP20 0,3900 0,5 m 05.20.02 CE

Ref

8231.1M	white tex
8231.2M	black tex
8231.4.2M	shiny gold
8231.14	alu satin
8231.16.2M	satin gold
8231.45	sun gold

built-up  
lightbulbs not included  
Leuchtmittel nicht einbegriffen

8227/.. - STILETTO

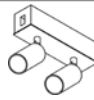

Junction box with 2x Jacob ledlight on bar 5cm - with LED driver  
Anschlußdose mit 2x Jacob LED Strahler auf Stange 5cm - mit Driver LED

Lamp type

2x led 467lm CRI80 max. 3,8W A+ - A+ 350mA

Dimensions

L183xB48xH47  $\sphericalangle$  48° reflector

~230V IP20 0,8100 0,5 m 05.20.50 CE

Ref

8227.1M	NW   WW
8227.2M	NW   WW
8227.4.2M	NW   WW
8227.14	NW   WW
8227.16.2M	NW   WW
8227.45.45	NW   WW

built-up



8236/.. - STILETTO

IP20   



Junction box with blind coverplate  
Anschlußdose mit Blindabdeckungsplatte

**Dimensions**

↳ L243xB48xH47

**Options**

TR122246 - DRIVER

**Materials**

aluminium 14 | 1M | 2M | 45  
brass 4 | 16

**Ref**

8236.1M	white tex
8236.2M	black tex
8236.4.2M	shiny gold
8236.14	alu satin
8236.16.2M	satin gold
8236.45	sun gold

room for driver  
Raum für Ledkonverter

8237/.. - STILETTO - 10,2

IP20  



Junction box with coverplate for 2 built-up spotlights  
Anschlußdose mit Abdeckplatte für 2 Aufbaustrahler auf Stange

**Dimensions**

↳ L243xB48xH47

**Materials**

aluminium 14 | 1M | 2M | 45  
brass 4 | 16

**Ref**

8237.1M	white tex
8237.2M	black tex
8237.4.2M	shiny gold
8237.14	alu satin
8237.16.2M	satin gold
8237.45	sun gold

spots to be ordered separately  
Strahler separat zu bestellen

8238/.. - STILETTO - 10,2

IP20  



Junction box with coverplate for 3 built-up spotlights  
Anschlußdose mit Abdeckplatte für 3 Aufbaustrahler auf Stange

**Dimensions**

↳ L243xB48xH47

**Materials**

aluminium 14 | 1M | 2M | 45  
brass 4 | 16

**Ref**

8238.1M	white tex
8238.2M	black tex
8238.4	shiny gold
8238.14	alu satin
8238.16	satin gold
8238.45	sun gold

spots to be ordered separately  
Strahler separat zu bestellen

8239/.. - STILETTO - 10,2

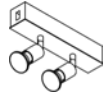

Junction box with 2x Capa spotlight on bar 5cm  
Anschlußdose mit 2x Capa Strahler auf Stange 5cm

Lamp type

2x QPAR 51 GU10 max. 20W A+ - E 230V  
or 2x QPAR70 GU10 max. 7W A+ 230V

Dimensions

L243xB48xH47

Materials

aluminium 14 | 1M | 2M | 45  
brass 4 | 16

~230V IP20

Ref

8239.1M	white tex
8239.2M	black tex
8239.4.2M	shiny gold
8239.14	alu satin
8239.16.2M	satin gold
8239.45	sun gold

built-up  
lightbulbs not included  
Leuchtmittel nicht einbegriffen

8256/.. - STILETTO - 10,2

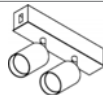

Junction box with 2x Capa X spotlight on bar 5cm  
Anschlußdose mit 2x Capa X Strahler auf Stange 5cm

Lamp type

2x QPAR 51 GU10 max. 20W A+ - E 230V  
2x QPAR70 GU10 max. 7W A+ 230V

Dimensions

L243xB48xH47

Materials

aluminium 14 | 1M | 2M | 45  
brass 4 | 16

~230V IP20

Ref

8256.1M	white tex
8256.2M	black tex
8256.4.2M	shiny gold
8256.14	alu satin
8256.16.2M	satin gold
8256.45	sun gold

built-up  
lightbulbs not included  
Leuchtmittel nicht einbegriffen

8257/.. - STILETTO - 10,2

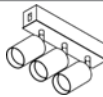

Junction box with 3x Capa X spotlight on bar 5cm  
Anschlußdose mit 3x Capa X Strahler auf Stange 5cm

Lamp type

3x QPAR 51 GU10 max. 20W A+ - E 230V  
3x QPAR70 GU10 max. 7W A+ 230V

Dimensions

L243xB48xH47

Materials

aluminium 14 | 1M | 2M | 45  
brass 4 | 16

~230V IP20

Ref

8257.1M	white tex
8257.2M	black tex
8257.4	shiny gold
8257.14	alu satin
8257.16	satin gold
8257.45	sun gold

built-up  
lightbulbs not included  
Leuchtmittel nicht einbegriffen

8240/.. - STILETTO - 10,2

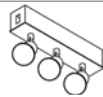

Junction box with 3x Capa spotlight on bar 5cm  
Anschlußdose mit 3x Capa Strahler auf Stange 5cm

Lamp type

3x QPAR 51 GU10 max. 20W A+ - E 230V  
or 3x QPAR70 GU10 max. 7W A+ 230V

Dimensions

L243xB48xH47

Materials

aluminium 14 | 1M | 2M | 45  
brass 4 | 16

~230V IP20

Ref

8240.1M	white tex
8240.2M	black tex
8240.4.2M	shiny gold
8240.14	alu satin
8240.16.2M	satin gold
8240.45	sun gold

built-up  
lightbulbs not included  
Leuchtmittel nicht einbegriffen

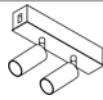

8241/.. - STILETTO

~230V      



Junction box with 2x Jacob ledlight on bar 5cm - with LED driver  
Anschlußdose mit 2x Jacob LED Strahler auf Stange 5cm - mit Driver LED

Lamp type

2x led 467lm CRI80 max. 3,8W  -  350mA

Dimensions

L243xB48xH47 

Ref

8241.1M	NW   WW
8241.2M	NW   WW
8241.4.2M	NW   WW
8241.14	NW   WW
8241.16.2M	NW   WW
8241.45.45	NW   WW

built-up

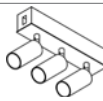

8242/.. - STILETTO

~230V      



Junction box with 3x Jacob ledlight on bar 5cm - with LED driver  
Anschlußdose mit 3x Jacob LED Strahler auf Stange 5cm - mit Driver LED

Lamp type

3x led 467lm CRI80 max. 3,8W  -  350mA

Dimensions

L243xB48xH47 

Ref

8242.1M	NW   WW
8242.2M	NW   WW
8242.4.2M	NW   WW
8242.14	NW   WW
8242.16.2M	NW   WW
8242.45.45	NW   WW

built-up



8243/.. - STILETTO

IP20  

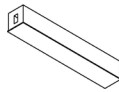

Junction box with blind coverplate  
Anschlußdose mit Blindabdeckungsplatte

**Dimensions**

↔ L300xB45xH45

**Materials**

aluminium 14 | 1M | 2M | 45  
brass 4 | 16

**Ref**

8243.1M	white tex
8243.2M	black tex
8243.4.2M	shiny gold
8243.14	alu satin
8243.16.2M	satin gold
8243.45	sun gold

room for driver  
Raum für Ledkonverter

8244/.. - STILETTO

~230V  IP20    

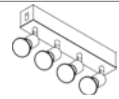

Junction box with 4x Capa spotlight on bar 5cm  
Anschlußdose mit 4x Capa Strahler auf Stange 5cm

**Lamp type**

☞ 4x QPAR 51 GU10 max. 20W  -  230V

or ☞ 4x QPAR70 GU10 max. 7W  230V

**Dimensions**

↔ L303xB48xH47

**Materials**

aluminium 14 | 1M | 2M | 45  
brass 4 | 16

**Ref**

8244.1M	white tex
8244.2M	black tex
8244.4.2M	shiny gold
8244.14	alu satin
8244.16.2M	satin gold
8244.45	sun gold

built-up  
lightbulbs not included  
Leuchtmittel nicht einbegriffen

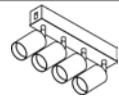

8258/.. - STILETTO

~230V  IP20    



Junction box with 4x Capa X spotlight on bar 5cm  
Anschlußdose mit 4x Capa X Strahler auf Stange 5cm

**Lamp type**

☞ 4x QPAR 51 GU10 max. 20W  -  230V

☞ 4x QPAR70 GU10 max. 7W  230V

**Dimensions**

↔ L303xB48xH47

**Materials**

aluminium 14 | 1M | 2M | 45  
brass 4 | 16

**Ref**

8258.1M	white tex
8258.2M	black tex
8258.4.2M	shiny gold
8258.14	alu satin
8258.16.2M	satin gold
8258.45	sun gold

built-up  
lightbulbs not included  
Leuchtmittel nicht einbegriffen



8245/.. - STILETTO

IP20  

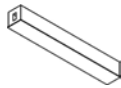

Junction box with blind coverplate  
Anschlußdose mit Blindabdeckungsplatte

**Dimensions**

↔ L363xB48xH47

**Materials**

aluminium 14 | 1M | 2M | 45  
brass 4 | 16

**Ref**

8245.1M	white tex
8245.2M	black tex
8245.4.2M	shiny gold
8245.14	alu satin
8245.16.2M	satin gold
8245.45	sun gold

room for driver  
Raum für Ledkonverter

8246/.. - STILETTO

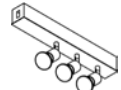

~230V  IP20    



Junction box with 3x Capa spotlight on bar 5cm  
Anschlußdose mit 3x Capa Strahler auf Stange 5cm

**Lamp type**

 3x QPAR 51 GU10 max. 20W  -  230V

or  3x QPAR70 GU10 max. 7W  230V

**Dimensions**

↔ L363xB48xH47

**Materials**

aluminium 14 | 1M | 2M | 45  
brass 4 | 16

**Ref**

8246.1M	white tex
8246.2M	black tex
8246.4	shiny gold
8246.14	alu satin
8246.16	satin gold
8246.45	sun gold

built-up  
lightbulbs not included  
Leuchtmittel nicht einbegriffen

8259/.. - STILETTO

~230V  IP20    

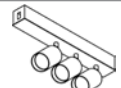

Junction box with 3x Capa X spotlight on bar 5cm  
Anschlußdose mit 3x Capa X Strahler auf Stange 5cm

**Lamp type**

 3x QPAR 51 GU10 max. 20W  -  230V

**Dimensions**

↔ L363xB48xH47

**Materials**

aluminium 14 | 1M | 2M | 45  
brass 4 | 16

**Ref**

8259.1M	white tex
8259.2M	black tex
8259.4.2M	shiny gold
8259.14	alu satin
8259.16.2M	satin gold
8259.45	sun gold

built-up  
lightbulbs not included  
Leuchtmittel nicht einbegriffen

8247/.. - STILETTO

~230V  IP20  0,5 m 05.20.50 

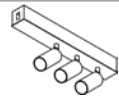

Junction box with 3x Jacob ledlight on bar 5cm - with LED driver  
Anschlußdose mit 3x Jacob LED Strahler auf Stange 5cm - mit Driver LED

Lamp type

3x led 467lm CRI80 max. 3,8W  350mA

Dimensions

L363xB48xH47  48° reflector

Ref

8247.1M	NW   WW
8247.2M	NW   WW
8247.4.2M	NW   WW
8247.14	NW   WW
8247.16.2M	NW   WW
8247.45.45	NW   WW

built-up

8248/.. - STILETTO

~230V  IP20  0,5 m 05.20.50 

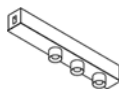

Junction box with 3 built-up spots ZiaLed M - with LED driver  
Anschlußdose mit 3 Aufbaustrahler ZiaLed M - mit Driver LED

Lamp type

3x led 467lm CRI80 max. 3,8W  350mA

Dimensions

L363xB48xH47  48° reflector

Ref

8248.1M	NW   WW
8248.2M	NW   WW
8248.14	NW   WW
8248.45	NW   WW

built-up

8249/.. - STILETTO

~230V  IP20  0,6500 0,5 m 05.20.50 

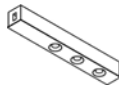

Junction box with 3x built-in spot ZiaLed M - with LED driver  
Anschlußdose mit 3x Einbaustrahler ZiaLed M - mit Driver LED

Lamp type

3x led 467lm CRI80 max. 3,8W  350mA

Dimensions

L363xB48xH47  48° reflector

Ref

8249.1M	NW   WW
8249.2M	NW   WW
8249.14	NW   WW
8249.45	NW   WW

built-up

8300/.. - STILETTO

IP20  



profile without spotlight or pendant  
 Profil ohne Pendelleuchte oder Strahler

**Dimensions**

L1300xB48xH48

**Materials**

aluminium

14 | 1M | 2M

**Ref**

8300.1M	white tex
8300.1M.4	white tex
8300.1M.16	white tex
8300.2M	black tex
8300.2M.4	black tex
8300.2M.16	black tex
8300.14.14	alu satin

SYSTEM UP



8250/.. - STILETTO

IP20   0,2100 



Connection profile 300mm - inclusive cable 3x1  
Verbindungsprofil 300mm - Kabel inklusief 3x1

**Dimensions**

↔ L300xB10xH20

**Materials**

aluminium	14   1M   2M   45
brass	4   16

**Ref**

8250.1M	white tex
8250.2M	black tex
8250.4	shiny gold
8250.14	alu satin
8250.16	satin gold
8250.45	sun gold

built-up

8251/.. - STILETTO

IP20   0,4200 



Connection profile 600mm - inclusive cable 3x1  
Verbindungsprofil - Kabel inklusief 3x1

**Dimensions**

↔ L600xB10xH20

**Materials**

aluminium	14   1M   2M   45
brass	4   16

**Ref**

8251.1M	white tex
8251.2M	black tex
8251.4	shiny gold
8251.14	alu satin
8251.16	satin gold
8251.45	sun gold

built-up

8252/.. - STILETTO

IP20   0,3100 



Connection profile 900mm - inclusive cable 3x1  
Verbindungsprofil 900mm - Kabel inklusief 3x1

**Dimensions**

↔ L900xB10xH20

**Materials**

aluminium	14   1M   2M   45
brass	4   16

**Ref**

8252.1M	white tex
8252.2M	black tex
8252.4	shiny gold
8252.14	alu satin
8252.16	satin gold
8252.45	sun gold

built-up

8253/.. - STILETTO

IP20   0,2900 



Connection profile 1200mm - inclusive cable 3x1  
Verbindungsprofil 1200mm - Kabel inklusief 3x1

**Dimensions**

↔ L1200xB10xH20

**Materials**

aluminium	14   1M   2M   45
brass	4   16

**Ref**

8253.1M	white tex
8253.2M	black tex
8253.4	shiny gold
8253.14	alu satin
8253.16	satin gold
8253.45	sun gold

built-up



8254/.. - STILETTO

IP20   0,2500 



Connection profile 1500mm - inclusive cable 3x1  
Verbindungsprofil 1500mm - Kabel inklusief 3x1

**Dimensions**

↔ L1500xB10xH20

**Materials**

aluminium	14   1M   2M   45
brass	4   16

**Ref**

8254.1M	white tex
8254.2M	black tex
8254.4	shiny gold
8254.14	alu satin
8254.16	satin gold
8254.45	sun gold

built-up

8255/.. - STILETTO

IP20   0,3500 



Connection profile 1800mm - inclusive cable 3x1  
Verbindungsprofil 1800mm - Kabel inklusief 3x1

**Dimensions**

↔ L1800xB10xH20

**Materials**

aluminium	14   1M   2M   45
brass	4   16

**Ref cat (LONG)**

8255.1M	white tex
8255.2M	black tex
8255.4	shiny gold
8255.14	alu satin
8255.16	satin gold
8255.45	sun gold

built-up

8260A/.. - STILETTO

IP20   0,0400 



Support cube for 2 connection profiles  
Unterstützungswürfel für zwei Verbindungsprofile

**Dimensions**

↔ L35xB30xH15

**Materials**

aluminium	14   1M   2M   45
brass	4   16

**Ref**

8260A.1M	white tex
8260A.2M	black tex
8260A.4	shiny gold
8260A.14	alu satin
8260A.16	satin gold
8260A.45	sun gold

built-up

8260B/.. - STILETTO

IP20   0,1200 



Support cube for 2 connection profiles  
Unterstützungswürfel für zwei Verbindungsprofile

**Dimensions**

↔ L35xB20xH15

**Materials**

aluminium	14   1M   2M   45
brass	4   16

**Ref**

8260B.1M	white tex
8260B.2M	black tex
8260B.4	shiny gold
8260B.14	alu satin
8260B.16	satin gold
8260B.45	sun gold

built-up

8262/.. - STILETTO

IP20   0.2900 



Vertical corner connector - cable inclusive 3x1  
Eckverbinder vertikal - Kabel Inklusief 3x1

**Dimensions**

↔ L150xB150-B10xH20

**Materials**

brass 4 | 14 | 16 | 1M | 2M | 45

**Ref**

8262.1M	white tex
8262.2M	black tex
8262.4	shiny gold
8262.14	alu satin
8262.16	satin gold
8262.45	sun gold

built-up

8263/.. - STILETTO

IP20  



Corner horizontal - inclusive cable 3x1  
Eckverbindung horizontal - Kabel Inklusief 3x1

**Dimensions**

↔ L150xB150-B20xH10

**Materials**

brass 4 | 14 | 16 | 1M | 2M | 45

**Ref**

8263.1M	white tex
8263.2M	black tex
8263.4	shiny gold
8263.14	alu satin
8263.16	satin gold
8263.45	sun gold

8264/.. - STILETTO

IP20   0.0500 



Endcap for junction box  
Endkappe für Verbindungsdose

**Dimensions**

↔ B20xH10xD8

**Materials**

aluminium 14 | 1M | 2M | 45

**Ref**

8264.1M	white tex
8264.2M	black tex
8264.14	alu satin
8264.45	sun gold

piece to cover 1 hole in the junction box  
Kappe um 1 Loch in der Verbindungsdose abzudichten

8265/.. - STILETTO

IP20   0.0500 

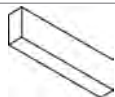

ornamental end piece  
ornamentales Endstück

**Dimensions**

↔ L50xB10xH20

**Materials**

aluminium 14 | 1M | 2M | 45  
brass 4 | 16

**Ref**

8265.1M	white tex
8265.2M	black tex
8265.4	shiny gold
8265.14	alu satin
8265.16	satin gold
8265.45	sun gold

8266/.. - STILETTO

IP20   



Connector for lightweight pendant or spotlight  
Montagenippel für lichte Pendelleuchte oder Strahler

**Dimensions**  
L50xB10xH20

**Materials**  
aluminium 14 | 1M | 2M | 45

Ref	
8266.1M	white tex
8266.2M	black tex
8266.14	alu satin
8266.45	sun gold

to be slid over the connection profile  
wird über das Verbindungsprofil geschoben

8267.M8X1/.. - STILETTO - M8

IP20   



fixed - Connector for heavier pendant or spotlight  
fest - Montagenippel für Schwere Pendelleuchte oder Strahler

**Dimensions**  
B20xH20xD47

**Materials**  
aluminium 14 | 1M | 2M | 45  
brass 4 | 16

Ref	
8267.M8X1.1M	white tex
8267.M8X1.2M	black tex
8267.M8X1.4	shiny gold
8267.M8X1.14	alu satin
8267.M8X1.16	satin gold
8267.M8X1.45	sun gold

built-up  
to be fixed on ceiling or wall  
befestigen an der Decke oder Wand

8267.M10X1/.. - STILETTO - M10

IP20  



Connector for heavier pendant or spotlight  
Montagenippel für Schwere Pendelleuchte oder Strahler





**Dimensions**  
B20xH20xD47

**Materials**  
aluminium 14 | 1M | 2M | 45  
brass 4 | 16

Ref	
8267.M10X1.1M	white tex
8267.M10X1.2M	black tex
8267.M10X1.4	shiny gold
8267.M10X1.14	alu satin
8267.M10X1.16	satin gold
8267.M10X1.45	sun gold

to be slid over the connection profile  
wird über das Verbindungsprofil geschoben

8270/.. - STILETTO

IP20    



torx screwdriver  
Sechskant-Schraubendreher

Ref  
8270

8268/.. - STILETTO

IP20   0,5 m  05.20.02 







Connection cable 3x1  
Anschlußkabel 3x1

Ref  
8268.2

black

8269/.. - STILETTO

IP20   0,5 m  05.20.02 







Connection cable 4x1  
Anschlußkabel 4x1

Ref  
8269.2

black

8271/.. - STILETTO

IP20   0,3500  0,5 m  05.20.02 



Connection cable 5x1  
Anschlußkabel 5x1

Ref  
8271.2

black





8273/.. - STILETTO - TIMES 45X45

IP20    



Blind module + coverplate for driver or built-up spot  
Die Blindmodul + Abdeckungsplatte zu Treiber oder  
Aufbaustrahler

Dimensions

↔ L100xB45xH45



Materials

aluminium 1M | 2M

Ref

8273.1M white tex  
8273.2M black tex

8274/.. - STILETTO - TIMES 45X45

IP20    



Blind module + coverplate for driver or built-up spot  
Die Blindmodul + Abdeckungsplatte zu Treiber oder  
Aufbaustrahler

Dimensions

↔ L360xB45xH45

Materials

aluminium 1M | 2M

Ref

8274.1M white tex  
8274.2M black tex



8275/.. - STILETTO - TIMES 45X45

~230V    IP20    



Profile + coverplate with 3 built-up led - with LED driver  
Profil + Abdeckplatte mit 3 Aufbauled - mit Driver LED

Lamp type

⊙ 3x led 467lm CRI80 max. 3,8W  -  350mA

Dimensions

↔ L360xB45xH45  48° reflector

Ref

8275.1M NW | WW  
8275.2M NW | WW



8276/.. - STILETTO - TIMES 45X45

~230V    IP20    



Profile + coverplate with 3 built-in led - with LED driver  
Profil + Abdeckplatte mit 3 Einbauled - mit Driver LED

Lamp type

⊙ 3x led 467lm CRI80 max. 3,8W  -  350mA

Dimensions

↔ L360xB45xH45  48° reflector

Ref

8276.1M NW | WW  
8276.2M NW | WW

8277/.. - STILETTO - TIMES 45X45

~230V

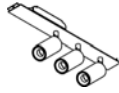

Profile + coverplate + 3 Jacob spotlights - with LED driver  
 Profil + Abdeckungsplatte + 3 Jacob Aufbaustrahler - mit Driver LED

Lamp type

3x led 467lm CRI80 max. 3,8W A+ - A+ 350mA

Dimensions

L360xB45xH45  $\wedge$  48° reflector

Ref

8277.1M

NW | WW

8277.2M

NW | WW

8278/.. - STILETTO - TIMES 45X45

~230V



profile + 3 spotlights Capa  
 Profil + 3 Capa Strahler

Lamp type

3x QPAR 51 GU10 max. 20W A+ - E 230V

or 3x QPAR70 GU10 max. 7W A+ 230V

Dimensions

L360xB45xH45

Materials

aluminium 1M | 2M

Ref

8278.1M

white tex

8278.2M

black tex

8279/.. - STILETTO - TIMES 45X45

~230V



profile + 3 spotlights Capa X  
 Profil + 3 Capa X Strahler

Lamp type

3x QPAR 51 GU10 max. 20W A+ - E 230V

3x QPAR70 GU10 max. 7W A+ 230V

Dimensions

L360xB45xH45

Materials

aluminium 1M | 2M

Ref

8279.1M

white tex

8279.2M

black tex



8285/.. - STILETTO - TIMES 45X45

~230V   IP20  0,5 m  05.20.50 



Module with 3 ledlines - with LED driver  
Modul mit 3 Linie Led - mit Driver LED

Lamp type

3x Led 1250lm CRI80 max. 7,4W  -  325mA

Dimensions

L1304xB45xH45

Ref

8285.1M	NW   WW
8285.2M	NW   WW



8286/.. - STILETTO - TIMES 45X45

~230V   IP20  0,5 m  05.20.50 



Module with 4 ledlines - with LED driver  
Modul mit 4 Linie Led - mit Driver LED

Lamp type

4x Led 1250lm CRI80 max. 7,4W  -  325mA

Dimensions

L1584xB45xH45

Ref

8286.1M	NW   WW
8286.2M	NW   WW



8287/.. - STILETTO - TIMES 45X45

~230V   IP20  0,5 m  05.20.50 



Module with 5 ledlines - with LED driver  
Modul mit 5 Linie Led - mit Driver LED

Lamp type

5x Led 1250lm CRI80 max. 7,4W  -  325mA





Dimensions

L1864xB45xH45

Ref cat (LONG)

8287.1M	NW   WW
8287.2M	NW   WW

8288/.. - STILETTO - TIMES 45X45

~230V   IP20  0,5 m  05.20.50 



Module with 6 ledlines - with LED driver  
Modul mit 6 Linie Led - mit Driver LED

Lamp type

5x Led 1250lm CRI80 max. 7,4W  -  325mA

Dimensions

L2144xB45xH45

Ref cat (LONG)

8288.1M	NW   WW
8288.2M	NW   WW



8290/.. - STILETTO - TIMES 45X70

~230V   IP20   0,5 m  05.20.50 



Module with 3 ledlines - with LED driver  
Modul mit 3 Linie Led - mit Driver LED

Lamptype

3x Led 1250lm CRI80 max. 7,4W  -  325mA

Dimensions

L1044xB45xH70

Ref

8290.1M

NW | WW

8290.2M

NW | WW

built-up

8291/.. - STILETTO - TIMES 45X70

~230V   IP20  3,3600  0,5 m  05.20.50 



Module with 4 ledlines - with LED driver  
Modul mit 4 Linie Led - mit Driver LED

Lamptype

4x Led 1250lm CRI80 max. 7,4W  -  325mA

Dimensions

L1324xB45xH70

Ref

8291.1M

NW | WW

8291.2M

NW | WW

built-up



8292/.. - STILETTO - TIMES 45X70

~230V   IP20   0,5 m  05.20.50 



Module with 5 ledlines - with LED driver  
Modul mit 5 Linie Led - mit Driver LED

Lamptype

5x Led 1250lm CRI80 max. 7,4W  -  325mA

Dimensions

L1604xB45xH70

Ref

8292.1M

NW | WW

8292.2M

NW | WW

built-up



8293/.. - STILETTO - TIMES 45X70

~230V   IP20   0,5 m  05.20.50 



Module with 6 ledlines - with LED driver  
Modul mit 6 Linie Led - mit Driver LED

Lamptype

6x Led 1250lm CRI80 max. 7,4W  -  325mA

Dimensions

L1884xB45xH70

Ref cat (LONG)

8293.1M

NW | WW

8293.2M

NW | WW

built-up



WALL UP

# INDOOR WALL UP

## Index

**A**

ARC 605

**B**

BETAPLUS 610-612

BRIDGE 633

BROOKLYN 654

**C**

CANARIA 614

CANVAS 620

CLARA 604

COMMA 657-658

**D**

DISPLAY 658-660

DUO 650-651

**E**

ENSOR 655-656

**F**

FARFALLE 578

FELX LITTLE JACOB 571-572

FLEX LITTLE CAPA 566-567

FLEX LITTLE JAMES 568-570

**G**

GASTON 562

GEORGE 560

GRAN CANARIA 614

GUILIA 637

**H**

HAVANA 616

HAVANA MIRROR 616

**I**

INDY 629-632

**J**

JACOB 654

JAMES WALL 576-577

**K**

KOBUS 606-608

**L**

LARA 613

LIPSTICK 563-565

LOTUS 615

**M**

MAESTRO 640-645

MAMBO 617-618

MANON 584

MAX 638

METRO 634

MICRO 620

MIKADO 634

MOBY 583

MONET 622-624

**N**

NOA 638

**O**

OLIVIA 646

OLIVIA MINI 646-647

OMEGA 635

ONTARIO 581-582

OPERA 648-649

ORKA 574-575

OUTSIDER 625

**P**

PIVA 579

POLINA 585-586

POLO 589-601

PROJECTA 655

**R**

RAYA 625

RAYA MINI 625

**S**

SHAKE 602-603

SURF 626

**T**

TAO 636

TOLEDO 627

TUBO 580

**U**

UNO 650

**V**

VEGA 621

VITO 652-653

VOLTA 573

**W**

WAVE 628

**Z**

ZEN 628



1048/.. - GEORGE

~230V  IP20   0,4100 0,5 05.20.50 



built-up wall light - fixed - down/up  
Wandleuchte für Aufbau - fest - down/up

**Lamp type**  
2x Led 500lm CRI80 max. 4W  230V

**Dimensions**  
B100xH100xD60

**Options**  
SGEORGE - GEORGE

Ref	
1048.1M	NW   WW
1048.2M	NW   WW
1048.29	NW   WW
1048.47	NW   WW
1048.49	NW   WW

built-up

1049/.. - GEORGE

~230V  IP20   0,4300 0,5 05.20.50 



built-up wall light - fixed - down/up  
Wandleuchte für Aufbau - fest - down/up

**Lamp type**  
2x Led 500lm CRI80 max. 4W  230V

**Dimensions**  
B100xH160xD60

**Options**  
SGEORGE - GEORGE

Ref	
1049.1M	NW   WW
1049.2M	NW   WW
1049.29	NW   WW
1049.49	NW   WW

built-up

1062/.. - GEORGE

~230V  IP20   0,5 05.20.50 



built-up wall light - fixed - down/up  
Wandleuchte für Aufbau - fest - down/up

**Lamp type**  
2x Led 500lm CRI80 max. 4W  230V

**Dimensions**  
B100xH280xD60

**Options**  
SGEORGE - GEORGE

Ref	
1062.1M	NW   WW
1062.2M	NW   WW
1062.29	NW   WW
1062.49	NW   WW

built-up



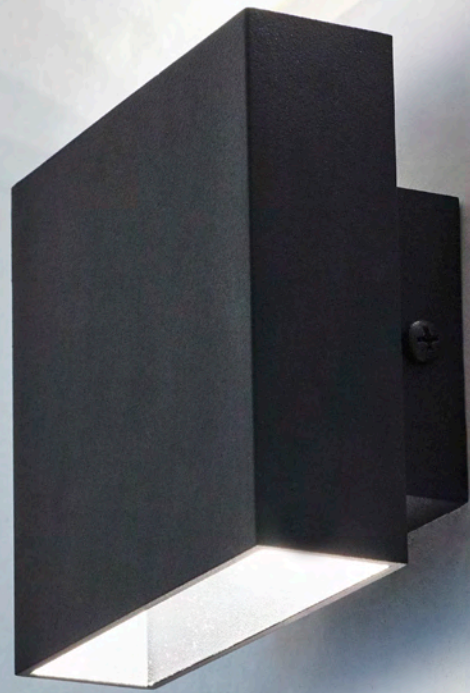

1064/.. - GASTON

~230V



IP20



0,3100

0,5 m

05.20.50

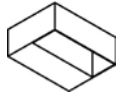

built-up wall light - fixed - down  
Wandleuchte für Aufbau - fest - down

Lamp type

1x Led 500lm CRI80 max. 4W A+ 230V

Dimensions

B104xH40xD80

Ref

1064.1M	NW   WW
1064.14	NW   WW
1064.29	NW   WW
1064.49	NW   WW



built-up

1066/.. - GASTON

~230V



IP20



0,5 m

05.20.50

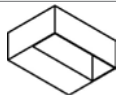

built-up wall light - fixed - down  
Wandleuchte für Aufbau - fest - down

Lamp type

1x 21LED L 1000lm CRI80 max. 8W A+ 230V

Dimensions

B104xH40xD80

Ref

1066.1M	NW   WW
1066.14	NW   WW
1066.29	NW   WW
1066.49	NW   WW



built-up

1067/.. - GASTON

~230V



IP20



0,5600

0,5 m

05.20.50

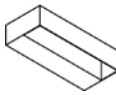

built-up wall light - fixed - down  
Wandleuchte für Aufbau - fest - down

Lamp type

2x Led 500lm CRI80 max. 4W A+ 230V

Dimensions

B184xH40xD80

Ref

1067.1M	NW   WW
1067.2M	NW   WW
1067.14	NW   WW
1067.29	NW   WW
1067.49	NW   WW



built-up

1068/.. - GASTON

~230V



IP20



0,5 m

05.20.50

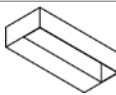

built-up wall light - fixed - down  
Wandleuchte für Aufbau - fest - down

Lamp type

2x 21LED L 1000lm CRI80 max. 8W A+ 230V

Dimensions

B184xH40xD80

Ref

1068.1M	NW   WW
1068.14	NW   WW
1068.29	NW   WW
1068.49	NW   WW



built-up

Tube available in L400 and L500 - smaller rosettes on request

Tube erhaltbar in L400 und L500 - Kleinere Rosette auf Anfrage

**1848/.. - LIPSTICK** =500mA



spotlight with flexible tube - directional - without switch - without LED driver  
 Aufbaustrahler mit flexibler Tube - schwenkbar - ohne Schalter - ohne Driver LED

**Ref**

1848.1M	NW   WW
1848.2M	NW   WW
1848.16	NW   WW
1848.162	NW   WW
1848.216	NW   WW

**Lamp type**  
 1x LED 190lm CRI80 max. 1,8W 500mA

**Dimensions**  
 Ø60xD395 - Flex 300  
 Base - Ø60xH25

**Options**  
 S1537 - LIPSTICK  
 TRMINI500MA - DRIVER

*built-up*

**1849/.. - LIPSTICK BY SUMUM** =500mA



spotlight with flexible tube - directional - without switch - without LED driver  
 Aufbaustrahler mit flexibler Tube - schwenkbar - ohne Schalter - ohne Driver LED

**Ref**

1849.1M	NW   WW
1849.2M	NW   WW
1849.16	NW   WW
1849.162	NW   WW
1849.216	NW   WW

**Lamp type**  
 1x LED 190lm CRI80 max. 1,8W 500mA

**Dimensions**  
 Ø60xD415 - Flex 300  
 Base - Ø60xH25

**Options**  
 S1537 - LIPSTICK  
 TRMINI500MA - DRIVER

*built-up*

**1895/.. - LIPSTICK** =500mA



spotlight with flexible tube - directional - without switch - without LED driver  
 Aufbaustrahler mit flexibler Tube - schwenkbar - ohne Schalter - ohne Driver LED

**Ref**

1895.1M	NW   WW
1895.2M	NW   WW
1895.216	NW   WW

**Lamp type**  
 1x LED 190lm CRI80 max. 1,8W 500mA

**Dimensions**  
 L60xB40xD400 - Flex 300  
 Base - L60xB40xH30

**Options**  
 S1537 - LIPSTICK  
 TRMINI500MA - DRIVER

*built-up*

**1896/.. - LIPSTICK BY SUMUM** =500mA



spotlight with flexible tube - directional - without switch - without LED driver  
 Aufbaustrahler mit flexibler Tube - schwenkbar - ohne Schalter - ohne Driver LED

**Ref**

1896.1M	NW   WW
1896.2M	NW   WW
1896.216	NW   WW

**Lamp type**  
 1x LED 190lm CRI80 max. 1,8W 500mA

**Dimensions**  
 L60xB40xD420 - Flex 300  
 Base - L60xB40xH30

**Options**  
 S1537 - LIPSTICK  
 TRMINI500MA - DRIVER

*built-up*

WALL UP



## INDOOR | Wall UP | LIPSTICK

Tube available in L400 and L500 - smaller rosettes on request

Tube erhältlich in L400 und L500 - Kleinere Rosette auf Anfrage

### 1897/.. - LIPSTICK

=500mA



spotlight with flexible tube - directional - without switch - without LED driver  
Aufbaustrahler mit flexibler Tube - schwenkbar - ohne Schalter - ohne Driver LED

#### Lamp type

1x LED 190lm CRI80 max. 1,8W A 500mA

#### Dimensions

Ø90xD370 - Flex 300

Base - Ø90

#### Options

S1537 - LIPSTICK

TRMINI500MA - DRIVER

#### Ref

1897.1M	NW   WW
1897.2M	NW   WW
1897.16	NW   WW
1897.162	NW   WW
1897.216	NW   WW

#### built-in

mount to gyproc box with 2 screws  
mit 2 Schrauben an der Einbauschachtel für Gipsplatten befestigen

### 1898/.. - LIPSTICK BY SUMUM

=500mA



spotlight with flexible tube - directional - without switch - without LED driver  
Aufbaustrahler mit flexibler Tube - schwenkbar - ohne Schalter - ohne Driver LED

#### Lamp type

1x LED 190lm CRI80 max. 1,8W A 500mA

#### Dimensions

Ø90xD390 - Flex 300

Base - Ø90

#### Options

S1537 - LIPSTICK

TRMINI500MA - DRIVER

#### Ref

1898.1M	NW   WW
1898.2M	NW   WW
1898.16	NW   WW
1898.162	NW   WW
1898.216	NW   WW

#### built-in

mount to gyproc box with 2 screws  
mit 2 Schrauben an der Einbauschachtel für Gipsplatten befestigen

### 1899/.. - LIPSTICK

=500mA



spotlight with flexible tube - directional - without switch - without LED driver  
Aufbaustrahler mit flexibler Tube - schwenkbar - ohne Schalter - ohne Driver LED

#### Lamp type

1x LED 190lm CRI80 max. 1,8W A 500mA

#### Dimensions

L80xB80xD370 - Flex 300

Base - L80xB80

#### Options

S1537 - LIPSTICK

TRMINI500MA - DRIVER

#### Ref

1899.1M	NW   WW
1899.2M	NW   WW
1899.16	NW   WW
1899.162	NW   WW
1899.216	NW   WW

#### built-in

mount to gyproc box with 2 screws  
mit 2 Schrauben an der Einbauschachtel für Gipsplatten befestigen

### 1900/.. - LIPSTICK BY SUMUM

=500mA



spotlight with flexible tube - directional - without switch - without LED driver  
Aufbaustrahler mit flexibler Tube - schwenkbar - ohne Schalter - ohne Driver LED

#### Lamp type

1x LED 190lm CRI80 max. 1,8W A 500mA

#### Dimensions

L80xB80xD390 - Flex 300

Base - L80xB80xD

#### Options

S1537 - LIPSTICK

TRMINI500MA - DRIVER

#### Ref



1900.1M	NW   WW
1900.2M	NW   WW
1900.16	NW   WW
1900.162	NW   WW
1900.216	NW   WW

#### built-in

mount to gyproc box with 2 screws  
mit 2 Schrauben an der Einbauschachtel für Gipsplatten befestigen

Tube available in L400 and L500 - smaller rosettes on request  
 Tube erhältlich in L400 und L500 - Kleinere Rosette auf Anfrage

1905/.. - LIPSTICK

~230V    IP20    0,5 m  05.20.50 



spotlight with flexible tube - directional - without switch - with LED driver  
 Aufbaustrahler mit flexibler Tube - schwenkbar - ohne Schalter - mit Driver LED

**Lamp type**  
 1x LED 190lm CRI80 max. 1,8W  500mA

**Dimensions**  
 ØxD - Flex 300  
 Base - ØxH

**Options**  
 S1537 - LIPSTICK

Ref	
1905.1M	NW   WW
1905.2M	NW   WW
1905.16	NW   WW
1905.162	NW   WW
1905.216	NW   WW

**built-up**  
 With driver 4W - 500mA  
 Mit Driver 4W - 500mA

1906/.. - LIPSTICK BY SUMUM

~230V    IP20    0,5 m  05.20.50 



spotlight with flexible tube - directional - without switch - with LED driver  
 Aufbaustrahler mit flexibler Tube - schwenkbar - ohne Schalter - mit Driver LED

**Lamp type**  
 1x LED 190lm CRI80 max. 1,8W  500mA

**Dimensions**  
 ØxD - Flex 300  
 Base - ØxH

**Options**  
 S1537 - LIPSTICK

Ref	
1906.1M	NW   WW
1906.2M	NW   WW
1906.16	NW   WW
1906.162	NW   WW
1906.216	NW   WW

**built-up**  
 With driver 4W - 500mA  
 Mit Driver 4W - 500mA



WALL UP

1233.300/.. - FLEX LITTLE CAPA

~230V



*semi built-in/up*  
mount to gyproc box with 2 screws  
mit 2 Schrauben an der Einbauschachtel für  
Gipsplatten befestigen

spotlight with flexible tube - directional - without switch  
Aufbaustrahler mit flexibler Tube - schwenkbar - ohne  
Schalter

**Lamp type**

1x QPAR 51 GU10 max. 20W A+ - E 230V  
or 1x QPAR70 GU10 max. 7W A+ 230V

**Dimensions**

L80xB80xD340 - Flex 300

Ø68

Base - L80xB80

Head - Ø33xH43

**Materials**

aluminium 11 | 1M | 2M  
brass 16 | 23

**Ref**

1233.300.1M	white tex
1233.300.2M	black tex
1233.300.11	alu grey
1233.300.16	satin gold
1233.300.23	dark bronze

1379.300/.. - FLEX LITTLE CAPA

~230V



*semi built-in/up*  
mount to gyproc box with 2 screws  
mit 2 Schrauben an der Einbauschachtel für  
Gipsplatten befestigen

spotlight with flexible tube - directional - with switch  
Aufbaustrahler mit flexibler Tube - schwenkbar - mit Schalter

**Lamp type**

1x QPAR 51 GU10 max. 20W A+ - E 230V  
or 1x QPAR70 GU10 max. 7W A+ 230V

**Dimensions**

L80xB80xD340 - Flex 300

Ø68

Base - L80xB80

Head - Ø33xH43

**Materials**

aluminium 11 | 1M | 2M  
brass 16 | 23

**Ref**

1379.300.1M	white tex
1379.300.2M	black tex
1379.300.11	alu grey
1379.300.16	satin gold
1379.300.23	dark bronze

1167.300/.. - FLEX LITTLE CAPA

~230V



*semi built-in/up*  
mount to gyproc box with 2 screws  
mit 2 Schrauben an der Einbauschachtel für  
Gipsplatten befestigen

spotlight with flexible tube - directional - without switch  
Aufbaustrahler mit flexibler Tube - schwenkbar - ohne  
Schalter

**Lamp type**

1x QPAR 51 GU10 max. 20W A+ - E 230V  
or 1x QPAR70 GU10 max. 7W A+ 230V

**Dimensions**

Ø90xH340 - Flex 300

Ø68

Base - Ø90

Head - Ø33xH43

**Materials**

aluminium 11 | 1M | 2M  
brass 16 | 23

**Ref**

1167.300.1M	white tex
1167.300.2M	black tex
1167.300.11	alu grey
1167.300.16	satin gold
1167.300.23	dark bronze

1325.300/.. - FLEX LITTLE CAPA

~230V



*semi built-in/up*  
mount to gyproc box with 2 screws  
mit 2 Schrauben an der Einbauschachtel für  
Gipsplatten befestigen

spotlight with flexible tube - directional - with switch  
Aufbaustrahler mit flexibler Tube - schwenkbar - mit Schalter

**Lamp type**

1x QPAR 51 GU10 max. 20W A+ - E 230V  
or 1x QPAR70 GU10 max. 7W A+ 230V

**Dimensions**

Ø90xH340 - Flex 300

Ø68

Base - Ø90

Head - Ø33xH43

**Materials**

aluminium 11 | 1M | 2M  
brass 16 | 23

**Ref**

1325.300.1M	white tex
1325.300.2M	black tex
1325.300.11	alu grey
1325.300.16	satin gold
1325.300.23	dark bronze

3990.300/.. - FLEX LITTLE CAPA - M10

~230V



spotlight with flexible tube - directional - without switch  
Aufbaustrahler mit flexibler Tube - schwenkbar - ohne Schalter

Lamp type

1x QPAR 51 GU10 max. 20W A+ - E 230V

or 1x QPAR70 GU10 max. 7W A+ 230V

Base - Ø60xH25

Head - Ø33xH43

Materials

aluminium 11 | 1M | 2M

Ref

3990.300.1M	white tex
3990.300.2M	black tex
3990.300.11	alu grey

built-up

1131.300/.. - FLEX LITTLE CAPA

~230V



spotlight with flexible tube - directional - without switch  
Aufbaustrahler mit flexibler Tube - schwenkbar - ohne Schalter

Lamp type

1x QPAR 51 GU10 max. 20W A+ - E 230V

or 1x QPAR70 GU10 max. 7W A+ 230V

Dimensions

L60xB40xD370 - Flex 300

Base - L60xB40xD30

Head - Ø33xH43

Materials

aluminium 11 | 1M | 2M

Ref

1131.300.1M	white tex
1131.300.2M	black tex
1131.300.11	alu grey

built-up

1108.300/.. - FLEX LITTLE CAPA

~230V



spotlight with flexible tube - directional - with switch  
Aufbaustrahler mit flexibler Tube - schwenkbar - mit Schalter

Lamp type

1x QPAR 51 GU10 max. 20W A+ - E 230V

or 1x QPAR70 GU10 max. 7W A+ 230V

Dimensions

L60xB40xD370 - Flex 300

Base - L60xB40xD30

Head - Ø33xH43

Materials

aluminium 11 | 1M | 2M

Ref

1108.300.1M	white tex
1108.300.2M	black tex
1108.300.11	alu grey

built-up





1093.300/.. - FLEX LITTLE JAMES

=350mA 0,3000 0,5 m 05.20.50



spotlight with flexible tube - directional - without switch - without LED driver  
 Aufbaustrahler mit flexibler Tube - schwenkbar - ohne Schalter - ohne Driver LED

**Lamp type**  
 1x led 467lm CRI80 max. 3,8W - 350mA

**Dimensions**  
 L80xB80xD350 - Cable 300  
 Ø68  
 Base - L80xB80  
 Head - Ø40xH50

Ref	
1093.300.1M	NW   WW
1093.300.2M	NW   WW
1093.300.11	NW   WW
1093.300.29	NW   WW
1093.300.47	NW   WW
1093.300.49	NW   WW

semi built-in/up  
 mount to gyproc box with 2 screws  
 mit 2 Schrauben an der Einbauschachtel für Gipsplatten befestigen

1424.300/.. - FLEX LITTLE JAMES

=350mA 0,2800 0,5 m 05.20.50



spotlight with flexible tube - directional - with switch - without LED driver  
 Aufbaustrahler mit flexibler Tube - schwenkbar - mit Schalter - ohne Driver LED

**Lamp type**  
 1x led 467lm CRI80 max. 3,8W - 350mA

**Dimensions**  
 L80xB80xD350 - Flex 300  
 Ø68  
 Base - L80xB80  
 Head - Ø40xH50

Ref	
1424.300.1M	NW   WW
1424.300.2M	NW   WW
1424.300.11	NW   WW
1424.300.29	NW   WW
1424.300.47	NW   WW
1424.300.49	NW   WW

semi built-in/up  
 mount to gyproc box with 2 screws  
 mit 2 Schrauben an der Einbauschachtel für Gipsplatten befestigen

1173.300/.. - FLEX LITTLE JAMES

=350mA 0,5 m 05.20.50



spotlight with flexible tube - directional - without switch - without LED driver  
 Aufbaustrahler mit flexibler Tube - schwenkbar - ohne Schalter - ohne Driver LED

**Lamp type**  
 1x led 467lm CRI80 max. 3,8W - 350mA

**Dimensions**  
 Ø90xH350 - Flex 300  
 Ø68  
 Base - Ø90  
 Head - Ø40xH50

Ref	
1173.300.1M	NW   WW
1173.300.2M	NW   WW
1173.300.11	NW   WW
1173.300.29	NW   WW
1173.300.47	NW   WW
1173.300.49	NW   WW

semi built-in/up  
 mount to gyproc box with 2 screws  
 mit 2 Schrauben an der Einbauschachtel für Gipsplatten befestigen

1426.300/.. - FLEX LITTLE JAMES

=350mA 0,5 m 05.20.50



spotlight with flexible tube - directional - with switch - without LED driver  
 Aufbaustrahler mit flexibler Tube - schwenkbar - mit Schalter - ohne Driver LED

**Lamp type**  
 1x led 467lm CRI80 max. 3,8W - 350mA









**Dimensions**  
 Ø90xD350 - Flex 300  
 Ø68  
 Base - Ø90  
 Head - Ø40xH50

Ref	
1426.300.1M	NW   WW
1426.300.2M	NW   WW
1426.300.11	NW   WW
1426.300.29	NW   WW
1426.300.47	NW   WW
1426.300.49	NW   WW

semi built-in/up  
 mount to gyproc box with 2 screws  
 mit 2 Schrauben an der Einbauschachtel für Gipsplatten befestigen



WALL UP

1534.300/.. - FLEX LITTLE JAMES

~230V    IP20    0,5 m  05.20.50 



spotlight with flexible tube - directional - without switch - with LED driver  
 Aufbaustrahler mit flexibler Tube - schwenkbar - ohne Schalter - mit Driver LED









**Lamp type**  
 1x led 467lm CRI80 max. 3,8W  -  350mA

**Dimensions**  
 Ø80xH390 - Flex 300  
 Ø80xH40

Ref	
1534.300.1M	NW   WW
1534.300.2M	NW   WW
1534.300.11	NW   WW
1534.300.29	NW   WW
1534.300.47	NW   WW
1534.300.49	NW   WW



built-up

1535.300/.. - FLEX LITTLE JAMES

~230V    IP20    0,5 m  05.20.50 



spotlight with flexible tube - directional - with switch - with LED driver  
 Aufbaustrahler mit flexibler Tube - schwenkbar - mit Schalter - mit Driver LED

**Lamp type**  
 1x led 467lm CRI80 max. 3,8W  -  350mA

**Dimensions**  
 Ø80xH390 - Flex 300  
 Ø80xH40

Ref	
1535.300.1M	NW   WW
1535.300.2M	NW   WW
1535.300.11	NW   WW
1535.300.29	NW   WW
1535.300.47	NW   WW
1535.300.49	NW   WW

built-up

WALL UP



1089.300/.. - FLEX LITTLE JAMES

=350mA 0,5 m 05.20.50



spotlight with flexible tube - directional - without switch - without LED driver  
 Aufbaustrahler mit flexibler Tube - schwenkbar - ohne Schalter - ohne Driver LED

**Lamp type**  
 1x led 467lm CRI80 max. 3,8W - 350mA

**Dimensions**  
 L60xB40xD380 - Flex 300  
 Base - L60xB40xD30  
 Head - Ø40xH50

Ref	
1089.300.1M	NW   WW
1089.300.2M	NW   WW
1089.300.11	NW   WW
1089.300.29	NW   WW
1089.300.47	NW   WW
1089.300.49	NW   WW

built-up

1466.300/.. - FLEX LITTLE JAMES

=350mA 0,5 m 05.20.50



spotlight with flexible tube - directional - with switch - without LED driver  
 Aufbaustrahler mit flexibler Tube - schwenkbar - mit Schalter - ohne Driver LED

**Lamp type**  
 1x led 467lm CRI80 max. 3,8W - 350mA

**Dimensions**  
 L60xB40xD380 - 300  
 Base - L60xB40xD30  
 Head - Ø40xH50

Ref	
1466.300.1M	NW   WW
1466.300.2M	NW   WW
1466.300.11	NW   WW
1466.300.29	NW   WW
1466.300.47	NW   WW
1466.300.49	NW   WW

built-up

1128.300/.. - FLEX LITTLE JAMES

~230V 0,4500 0,5 m 05.20.50



spotlight with flexible tube - directional - without switch - with LED driver  
 Aufbaustrahler mit flexibler Tube - schwenkbar - ohne Schalter - mit Driver LED

**Lamp type**  
 1x led 467lm CRI80 max. 3,8W - 350mA

**Dimensions**  
 L110xB55xD390 - Flex 300  
 Base - L110xB55xD35  
 Head - Ø40xH50

Ref	
1128.300.1M	NW   WW
1128.300.2M	NW   WW
1128.300.11	NW   WW
1128.300.29	NW   WW
1128.300.47	NW   WW
1128.300.49	NW   WW

built-up

1116.300/.. - FLEX LITTLE JAMES

~230V 0,5300 0,5 m 05.20.50



spotlight with flexible tube - directional - with switch - with LED driver  
 Aufbaustrahler mit flexibler Tube - schwenkbar - mit Schalter - mit Driver LED

**Lamp type**  
 1x led 467lm CRI80 max. 3,8W - 350mA

**Dimensions**  
 L110xB55xD390 - Flex 300  
 Base - L110xB55xD35  
 Head - Ø40xH50

Ref	
1116.300.1M	NW   WW
1116.300.2M	NW   WW
1116.300.11	NW   WW
1116.300.29	NW   WW
1116.300.47	NW   WW
1116.300.49	NW   WW

built-up

1174.300/.. - FELX LITTLE JACOB

=350mA



spotlight with flexible tube - directional - without switch - without LED driver  
 Aufbaustrahler mit flexibler Tube - schwenkbar - ohne Schalter - ohne Driver LED

Lamp type

1x led 467lm CRI80 max. 3,8W - 350mA

Dimensions

L80xB80xD380 - Flex 300

Ø68

Base - L80xB80

Head - Ø40xH85

Ref

1174.300.1M	NW   WW
1174.300.2M	NW   WW
1174.300.11	NW   WW
1174.300.29	NW   WW
1174.300.47	NW   WW
1174.300.49	NW   WW

semi built-in/up  
 mount to gyproc box with 2 screws  
 mit 2 Schrauben an der Einbauschachtel für Gipsplatten befestigen

1373.300/.. - FLEX LITTLE JACOB

=350mA



spotlight with flexible tube - directional - with switch - without LED driver  
 Aufbaustrahler mit flexibler Tube - schwenkbar - mit Schalter - ohne Driver LED

Lamp type

1x led 467lm CRI80 max. 3,8W - 350mA

Dimensions

L80xB80xD385 - Flex 300

Ø68

Base - L80xB80

Head - Ø40xH85

Ref

1373.300.1M	NW   WW
1373.300.2M	NW   WW
1373.300.11	NW   WW
1373.300.29	NW   WW
1373.300.47	NW   WW
1373.300.49	NW   WW

semi built-in/up  
 mount to gyproc box with 2 screws  
 mit 2 Schrauben an der Einbauschachtel für Gipsplatten befestigen

1175.300/.. - FLEX LITTLE JACOB

=350mA

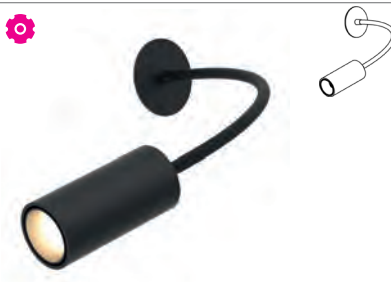

spotlight with flexible tube - directional - without switch - without LED driver  
 Aufbaustrahler mit flexibler Tube - schwenkbar - ohne Schalter - ohne Driver LED

Lamp type

1x led 467lm CRI80 max. 3,8W - 350mA

Dimensions

Ø90xH350 - Flex 300

Ø68

Base - Ø90

Head - Ø40xH85

Ref

1175.300.1M	NW   WW
1175.300.2M	NW   WW
1175.300.11	NW   WW
1175.300.29	NW   WW
1175.300.47	NW   WW
1175.300.49	NW   WW

semi built-in/up  
 mount to gyproc box with 2 screws  
 mit 2 Schrauben an der Einbauschachtel für Gipsplatten befestigen

1377.300/.. - FLEX LITTLE JACOB

=350mA

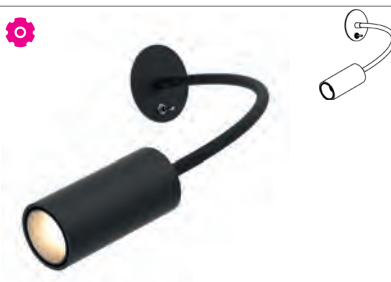

spotlight with flexible tube - directional - with switch - without LED driver  
 Aufbaustrahler mit flexibler Tube - schwenkbar - mit Schalter - ohne Driver LED

Lamp type

1x led 467lm CRI80 max. 3,8W - 350mA

Dimensions

Ø90xH385 - Flex 300

Ø68

Base - Ø90

Head - Ø40xH85

Ref

1377.300.1M	NW   WW
1377.300.2M	NW   WW
1377.300.11	NW   WW
1377.300.29	NW   WW
1377.300.47	NW   WW
1377.300.49	NW   WW

semi built-in/up  
 mount to gyproc box with 2 screws  
 mit 2 Schrauben an der Einbauschachtel für Gipsplatten befestigen



1468.300/.. - FLEX LITTLE JACOB

~230V



spotlight with flexible tube - directional - without switch - without LED driver  
 Aufbaustrahler mit flexibler Tube - schwenkbar - ohne Schalter - ohne Driver LED

Lamp type

1x led 467lm CRI80 max. 3,8W **A** - **A+** 350mA

Dimensions

L65xB40xD405 - 300

Base - L65xB40xD20

Head - Ø40xH85

Ref

1468.300.1M	NW   WW
1468.300.2M	NW   WW
1468.300.11	NW   WW
1468.300.29	NW   WW
1468.300.47	NW   WW
1468.300.49	NW   WW

built-up

1469.300/.. - FLEX LITTLE JACOB

~230V



spotlight with flexible tube - directional - with switch - without LED driver  
 Aufbaustrahler mit flexibler Tube - schwenkbar - mit Schalter - ohne Driver LED

Lamp type

1x led 467lm CRI80 max. 3,8W **A** - **A+** 350mA

Dimensions

L65xB40xD405 - 300

Base - L65xB40xD20

Head - Ø40xH85

Ref

1469.300.1M	NW   WW
1469.300.2M	NW   WW
1469.300.11	NW   WW
1469.300.29	NW   WW
1469.300.47	NW   WW
1469.300.49	NW   WW

built-up

1126.300/.. - FLEX LITTLE JACOB

~230V



spotlight with flexible tube - directional - without switch - with LED driver  
 Aufbaustrahler mit flexibler Tube - schwenkbar - ohne Schalter - mit Driver LED

Lamp type

1x led 467lm CRI80 max. 3,8W **A** - **A+** 350mA

Dimensions

L110xB55xD420 - Flex 300

Base - L110xB55xD35

Head - Ø40xH85

Ref

1126.300.1M	NW   WW
1126.300.2M	NW   WW
1126.300.11	NW   WW
1126.300.29	NW   WW
1126.300.47	NW   WW
1126.300.49	NW   WW

built-up

1127.300/.. - FLEX LITTLE JACOB

~230V



spotlight with flexible tube - directional - with switch - with LED driver  
 Aufbaustrahler mit flexibler Tube - schwenkbar - mit Schalter - mit Driver LED

Lamp type

1x led 467lm CRI80 max. 3,8W **A** - **A+** 350mA

Dimensions

L110xB55xD420 - Flex 300

Base - L110xB55xD35

Head - Ø40xH85

Ref

1127.300.1M	NW   WW
1127.300.2M	NW   WW
1127.300.11	NW   WW
1127.300.29	NW   WW
1127.300.47	NW   WW
1127.300.49	NW   WW

built-up

1962.ES50/.. - VOLTA FLEX - M10

~230V



spotlight with flexible tube - directional - without switch  
Aufbaustrahler mit flexibeler Tube - schwenkbar - ohne Schalter

**Lamp type**

1x QPAR70 GU10 max. 7W **A+** 230V

**Dimensions**

Ø60xH415 - Flex 300

Base - Ø60xH25

Head - Ø80xH90

**Materials**

aluminium 11 | 2M  
brass 16 | 23

**Ref**

1962.ES50.2M	black tex
1962.ES50.11	alu grey
1962.ES50.16	satin gold
1962.ES50.23	dark bronze

built-up

1958X.ES50/.. - VOLTA

~230V

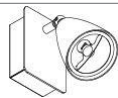

built-up wall light - directional - with switch  
Wandleuchte für Aufbau - schwenkbar - mit Schalter

**Lamp type**

1x QPAR70 GU10 max. 7W **A+** 230V

**Dimensions**

L100xB80xH150

Base - L100xB80xH42

**Materials**

aluminium 14 | 1M | 2M  
brass 13 | 23

**Ref**

1958X.ES50.1M	white tex
1958X.ES50.2M	black tex
1958X.ES50.13	bronze
1958X.ES50.14	alu satin
1958X.ES50.23	dark bronze

built-up

1958X/.. - VOLTA

~230V

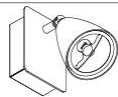

built-up wall light - directional - with switch - with transformer  
Wandleuchte für Aufbau - schwenkbar - mit Schalter - mit Trafo

**Lamp type**

1x QR-LP70 BA15d max. 50W **A+** - **E** 12V

**Dimensions**

L100xB80xH150

Base - L100xB80xH42

**Materials**

aluminium 14 | 1M | 2M  
brass 13 | 23

**Ref**

1958X.1M	white tex
1958X.2M	black tex
1958X.13	bronze
1958X.14	alu satin
1958X.23	dark bronze



built-up  
60VA

3021A/.. - ORKA WALL

~230V    IP20    0,6520 0,5 m 05.20.50 



built-up wall light - directional - with switch - with LED driver  
Wandleuchte für Aufbau - schwenkbar - mit Schalter - mit Driver LED

**Lamp type**  
1x powered 700mA max. 3W  -  700mA

**Dimensions**  
B80xH100xD40  $\angle$  40° reflector - Flex 300  
L90xB65

Ref	
3021A.2M	CW   WW
3021A.10	CW   WW
3021A.14	CW   WW
3021A.23	CW   WW

built-up  
other °angle reflector on demand  
andere °Winkel Reflektor auf Anfrage

3021B/.. - ORKA WALL

~230V    IP20    0,7140 0,5 m 05.20.50 



built-up wall light - directional - without switch - with LED driver  
Wandleuchte für Aufbau - schwenkbar - ohne Schalter - mit Driver LED

**Lamp type**  
1x powered 700mA max. 3W  -  700mA

**Dimensions**  
B80xH100xD40  $\angle$  40° reflector - Flex 300  
L90xB65

Ref	
3021B.10	CW   WW
3021B.14	CW   WW
3021B.23	CW   WW

built-up  
other °angle reflector on demand  
andere °Winkel Reflektor auf Anfrage

3022A/.. - ORKA WALL

~230V     IP20    0,5780 0,5 m 05.20.50 



built-in wall light - directional - with switch - for Helia built-in box 275 or 276 (4 screws) - with LED driver  
Einbau Wandleuchte - schwenkbar - mit Schalter - für Helia Dose 275 oder 276 (4 Schrauben) - mit Driver LED

**Lamp type**  
1x powered 700mA max. 3W  -  700mA

**Dimensions**  
B80xH90  $\angle$  40° reflector - Flex 300

Ref	
3022A.1M	CW   WW
3022A.2M	CW   WW
3022A.14	CW   WW
3022A.23	CW   WW

semi built-in/up  
other °angle reflector on demand  
andere °Winkel Reflektor auf Anfrage

3022B/.. - ORKA WALL

~230V    IP20    0,5790 0,5 m 05.20.50 

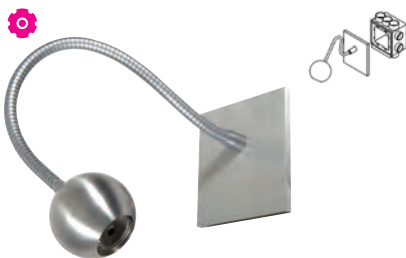

built-in wall light - directional - without switch - for built-in box Helia 275 or 276 (4 screws) - with LED driver  
Einbau Wandleuchte - schwenkbar - ohne Schalter - für Helia Dose 275 oder 276 (4 Schrauben) - mit Driver LED

**Lamp type**  
1x powered 700mA max. 3W  -  700mA

**Dimensions**  
B80xH90  $\angle$  40° reflector - Flex 300

Ref	
3022B.1M	CW   WW
3022B.2M	CW   WW
3022B.14	CW   WW
3022B.23	CW   WW

semi built-in/up  
other °angle reflector on demand  
andere °Winkel Reflektor auf Anfrage

3022C/.. - ORKA WALL

~230V



IP20



built-in wall light - directional - without switch - for built-in box Helia 275 or 276 (4 screws) - with LED driver  
 Einbau Wandleuchte - schwenkbar - ohne Schalter - für Helia Dose 275 oder 276 (4 Schrauben) - mit Driver LED

Lamp type

2x powered 700mA max. 3W A - A+ 700mA

Dimensions

B80xH90 40° reflector - Flex 300

Ref

3022C.1M	CW   WW
3022C.2M	CW   WW
3022C.14	CW   WW
3022C.23	CW   WW









semi built-in/up  
 other °angle reflector on demand  
 andere °Winkel Reflektor auf Anfrage



WALL UP



1046.JACOB/.. - JAMES WALL

~230V        



built-up

built-up wall light - directional - with flexible arm - with LED driver  
Wandleuchte für Aufbau - schwenkbar - mit Flexibele Tube - mit Driver LED

**Lamp type**  
1x led 467lm CRI80 max. 3,8W  -  350mA

**Dimensions**  
L420xB25xH1300  48° reflector  
Head - Ø40xH85  
Flexible - L300

**Ref**

1046.JACOB.1M	NW   WW
1046.JACOB.2M	NW   WW
1046.JACOB.16	NW   WW

1046.VOLTA/.. - JAMES WALL

~230V  IP20     



built-up

built-up wall light - directional - with flexible arm  
Wandleuchte für Aufbau - schwenkbar - mit Flexibele Tube

**Lamp type**  
1x QPAR 51 GU10 max. 20W  -  230V

**Dimensions**  
L425xB25xH1300  
Head - Ø80xH90  
Flexible - L300

**Materials**  
aluminium 1M | 2M  
brass 16

**Ref**

1046.VOLTA.1M	white tex
1046.VOLTA.2M	black tex
1046.VOLTA.16	satin gold

1046.CAPAX/.. - JAMES WALL

~230V  IP20     



built-up

built-up wall light - directional - with flexible arm  
Wandleuchte für Aufbau - schwenkbar - mit Flexibele Tube

**Lamp type**  
1x QPAR 51 GU10 max. 20W  -  230V

**Dimensions**  
L385xB25xH1300  
Head - Ø40xH50  
Flexible - L300

**Materials**  
aluminium 1M | 2M  
brass 16

**Ref**

1046.CAPAX.1M	white tex
1046.CAPAX.2M	black tex
1046.CAPAX.16	satin gold



1046.CAPA/.. - JAMES WALL

~230V  IP20     



built-up

built-up wall light - directional - with flexible arm  
Wandleuchte für Aufbau - schwenkbar - mit Flexibele Tube

**Lamp type**  
1x QPAR 51 GU10 max. 20W  -  230V  
or 1x QPAR70 GU10 max. 7W  230V



**Dimensions**  
L378xB25xH1300  
Head - Ø33xH43  
Flexible - L300

**Materials**  
aluminium 1M | 2M  
brass 16

**Ref**

1046.CAPA.1M	white tex
1046.CAPA.2M	black tex
1046.CAPA.16	satin gold

1047/.. - JAMES WALL

~230V    IP20    0,5 m  





built-up

1

built-up wall light - directional - with movable arm - with LED driver  
 Wandleuchte für Aufbau - schwenkbar - mit beweglicher Arm  
 - mit Driver LED

Ref	
1047.1M	NW   WW
1047.2M	NW   WW
1047.16	NW   WW

**Lamp type**  
 2x led 467lm CRI80 max. 3,8W  -  350mA

**Dimensions**  
 L400xB20xH1500  48° reflector



WALL UP

1369/.. - FARFALLE

~230V

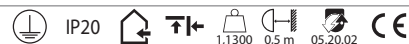

built-up ceiling or wall light - fixed  
Decken- oder Wandleuchte für Aufbau - fest

Lamp type

1x A60 E27 max. 10,5W A - E 230V

Dimensions

Ø390xH70

Materials

aluminium 1M | 2M | 45 | 78 | 79 | 81 | 93

Ref

1369.1M	white tex
1369.2M	black tex
1369.45	sun gold
1369.93	bronze-brown
1369.78	pastel blue
1369.79	pastel pink
1369.81	pastel green

built-up

1368/.. - FARFALLE

~230V

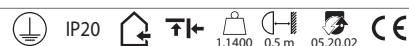

built-up ceiling or wall light - fixed  
Decken- oder Wandleuchte für Aufbau - fest

Lamp type

1x A60 E27 max. 10,5W A - E 230V

Dimensions

Ø320xH70

Materials

aluminium 1M | 2M | 45 | 78 | 79 | 81 | 93

Ref

1368.1M	white tex
1368.2M	black tex
1368.45	sun gold
1368.93	bronze-brown
1368.78	pastel blue
1368.79	pastel pink
1368.81	pastel green

built-up

WALL UP



5032/.. - PIVA WALL

~230V

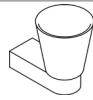

built-up wall light - up - with glass silk satin 8285S  
 Wandleuchte für Aufbau - up - mit Glass Silk Satin 8285S

**Lamp type**

1x QT14 G9 max. 25W A - E 230V

**Dimensions**

L135xB95xD135

**Materials**

aluminium 14 | 1M | 2M | 46

**Ref**

5032.1M	white tex
5032.2M	black tex
5032.14	alu satin
5032.46	grey-brown

built-up



5201.E27.G80/.. - TUBO

~230V  IP20    0,5 m  05.20.02 



built-up wall light - fixed - up or down  
Wandleuchte für Aufbau - fest - up or down

**Lamp type**  
1x G80 E27 max. 6W  -  **230V**

**Dimensions**  
Ø55xL90xH90  
Tube - Ø55

**Materials**  
brass 16  
INOX 304 1M | 2M | 45 | 11M

Ref	
5201.E27.G80.1M	white tex
5201.E27.G80.2M	black tex
5201.E27.G80.11M	grey tex
5201.E27.G80.16	satin gold
5201.E27.G80.45	sun gold



built-up

5201.E27.G125/.. - TUBO

~230V  IP20    0,4800  0,5 m  05.20.02 



built-up wall light - fixed - up or down  
Wandleuchte für Aufbau - fest - up or down

**Lamp type**  
1x G125 E27 max. 6W  -  **230V**

**Dimensions**  
Ø55xL105xH90  
Tube - Ø55

**Materials**  
brass 16  
INOX 304 1M | 2M | 45 | 11M

Ref	
5201.E27.G125.1M	white tex
5201.E27.G125.2M	black tex
5201.E27.G125.11M	grey tex
5201.E27.G125.16	satin gold
5201.E27.G125.45	sun gold

built-up

5201.ES50/.. - TUBO

~230V  IP20    0,5300  0,5 m  05.20.02 



built-up wall light - fixed - up or down  
Wandleuchte für Aufbau - fest - up or down

**Lamp type**  
1x QPAR 51 GU10 max. 20W  -  **230V**

**Dimensions**  
H90xD90  
Tube - Ø55

**Materials**  
brass 16  
INOX 304 1M | 2M | 45 | 11M

Ref	
5201.ES50.1M	white tex
5201.ES50.2M	black tex
5201.ES50.11M	grey tex
5201.ES50.16	satin gold
5201.ES50.45	sun gold

built-up

5113.R/.. - ONTARIO

~230V

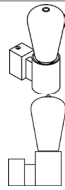

built-up wall light - without front plate - with round lampholder housing  
Wandleuchte für Aufbau - ohne Frontplatte - mit rundem Fassungsgehäuse

Lamp type

1x ST64 E27 max. 40W A - E 230V

Dimensions

Ø50xH65xD90

B25xH45

Materials

aluminium	14   1M   2M
brass	16
red copper	56

Ref

5113.R.1M	white tex
5113.R.2M	black tex
5113.R.14	alu satin
5113.R.16	satin gold
5113.R.56	red copper shiny

built-up

5110.R/.. - ONTARIO

~230V

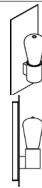

built-up wall light - with front plate and round lampholder  
Wandleuchte für Aufbau - mit Frontplatte und rundem Fassungsgehäuse

Lamp type

1x ST64 E27 max. 40W A - E 230V

Dimensions

L120xB300xD85

B80xH255

Materials

aluminium	14   1M   2M
brass	16
red copper	56

Ref

5110.R.1M	white tex
5110.R.2M	black tex
5110.R.14	alu satin
5110.R.16	satin gold
5110.R.56	red copper shiny

built-up

5111.R/.. - ONTARIO

~230V



built-up wall light - with front plate and round lampholder  
Wandleuchte für Aufbau - mit Frontplatte und rundem Fassungsgehäuse

Lamp type

1x ST64 E27 max. 40W A - E 230V

Dimensions

B210xH300xD85

B80xH255

Materials

aluminium	14   1M   2M
brass	16
red copper	56

Ref

5111.R.1M	white tex
5111.R.2M	black tex
5111.R.14	alu satin
5111.R.16	satin gold
5111.R.56	red copper shiny

built-up

5112.R/.. - ONTARIO

~230V

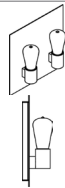

built-up wall light - with front plate and round lampholder  
Wandleuchte für Aufbau - mit Frontplatte und rundem Fassungsgehäuse

Lamp type

2x ST64 E27 max. 40W A - E 230V

Dimensions

B300xH300xD85

B255xH255

Materials

aluminium	14   1M   2M
brass	16
red copper	56

Ref

5112.R.1M	white tex
5112.R.2M	black tex
5112.R.14	alu satin
5112.R.16	satin gold
5112.R.56	red copper shiny

built-up

5113.S/.. - ONTARIO

~230V

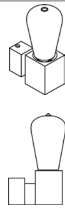

built-up wall light - without front plate - with square lampholder housing  
Wandleuchte für Aufbau - ohne Frontplatte - mit quadratischem Fassungsgehäuse

Lamp type

1x ST64 E27 max. 40W A - E 230V

Dimensions

B50xH65xD100

B25xH44

Materials

aluminium	14   1M   2M
brass	16
red copper	56

Ref

5113.S.1M	white tex
5113.S.2M	black tex
5113.S.14	alu satin
5113.S.16	satin gold
5113.S.56	red copper shiny

built-up

5110.S/.. - ONTARIO

~230V

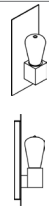

built-up wall light - with front plate and square lampholder  
Wandleuchte für Aufbau - mit Frontplatte und quadratischem Fassungsgehäuse

Lamp type

1x ST64 E27 max. 40W A - E 230V

Dimensions

B120xH300xD100

B75xH255

Materials

aluminium	14   1M   2M
brass	16
red copper	56

Ref

5110.S.1M	white tex
5110.S.2M	black tex
5110.S.14	alu satin
5110.S.16	satin gold
5110.S.56	red copper shiny

built-up

5111.S/.. - ONTARIO

~230V

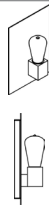

built-up wall light - with front plate and square lampholder  
Wandleuchte für Aufbau - mit Frontplatte und quadratischem Fassungsgehäuse

Lamp type

1x ST64 E27 max. 40W A - E 230V

Dimensions

B210xH300xD90

B75xH255

Materials

aluminium	14   1M   2M
brass	16
red copper	56

Ref

5111.S.1M	white tex
5111.S.2M	black tex
5111.S.2M.1M	black tex
5111.S.14	alu satin
5111.S.16	satin gold
5111.S.56	red copper shiny

built-up

5112.S/.. - ONTARIO

~230V

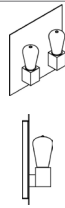

built-up wall light - with front plate and square lampholder  
Wandleuchte für Aufbau - mit Frontplatte und quadratischem Fassungsgehäuse

Lamp type

2x ST64 E27 max. 40W A - E 230V

Dimensions

B300xH300xD90

B255xH255

Materials

aluminium	14   1M   2M
brass	16
red copper	56

Ref

5112.S.1M	white tex
5112.S.2M	black tex
5112.S.2M.1M	black tex
5112.S.14	alu satin
5112.S.16	satin gold
5112.S.56	red copper shiny

built-up

5161.A/.. - MOBY GLASS

~230V  IP20    0,5 m  05.20.02  



built-up wall light - fixed - with E27 lampholder  
Wandleuchte für Aufbau - fest - mit E27 Fassung

**Lamp type**

◀ 1x A60 E27 max. 28W  A -  E ▶ 230V

**Dimensions**

↔ B140xH210xD170

Base - B50xH70xD120

Glass - Ø140

**Materials**

aluminium 1M | 2M

**Ref**

5161.A.1M.BZ	white tex
5161.A.1M.TR	white tex
5161.A.1M.SG	white tex
5161.A.2M.BZ	black tex
5161.A.2M.TR	black tex
5161.A.2M.SG	black tex

built-up

5160.A/.. - MOBY GLASS

~230V  IP20    0,5 m  05.20.02  



built-up wall light - fixed - with E27 lampholder  
Wandleuchte für Aufbau - fest - mit E27 Fassung

**Lamp type**

◀ 1x A60 E27 max. 40W  A -  E ▶ 230V

**Dimensions**

↔ B140xH250xD195

↕ B60xH110xD25

Glass - Ø140

**Materials**

aluminium 1M | 2M

**Ref**

5160.A.1M.BZ	white tex
5160.A.1M.TR	white tex
5160.A.1M.SG	white tex
5160.A.2M.BZ	black tex
5160.A.2M.TR	black tex
5160.A.2M.SG	black tex

built-up

5160.B/.. - MOBY GLASS

~230V  IP20    0,5 m  05.20.02  



built-up wall light - fixed - with E27 lampholder  
Wandleuchte für Aufbau - fest - mit E27 Fassung

**Lamp type**

◀ 1x A60 E27 max. 40W  A -  E ▶ 230V

**Dimensions**

↔ B180xH290xD215

Base - B60xH110xD25

Glass - Ø180

**Materials**

aluminium 1M | 2M

**Ref**

5160.B.1M.BZ	white tex
5160.B.1M.TR	white tex
5160.B.1M.SG	white tex
5160.B.2M.BZ	black tex
5160.B.2M.TR	black tex
5160.B.2M.SG	black tex

built-up





5144.P/.. - MANON

~230V  IP20        



built-up wall light - fixed - with E27 lampholder  
Wandleuchte für Aufbau - fest - mit E27 Fassung

**Lamp type**

 1x IT-32 E27 max. 8W  230V

**Dimensions**

 B125xH380xD160

Base - B50xH70xD120

Glass - Ø125xH315

**Materials**

aluminium 1M | 2M

**Ref**

5144.P.1M.BZ	white tex
5144.P.1M.TR	white tex
5144.P.1M.ST	white tex
5144.P.2M.BZ	black tex
5144.P.2M.TR	black tex
5144.P.2M.ST	black tex

built-up

5144.N/.. - MANON

~230V  IP20        



built-up wall light - fixed - with E27 lampholder  
Wandleuchte für Aufbau - fest - mit E27 Fassung

**Lamp type**

 1x A60 E27 max. 28W   230V

**Dimensions**

 B170xH240xD185

Base - B50xH70xD120

Glass - Ø170xH175

**Materials**

aluminium 1M | 2M

**Ref**

5144.N.1M.BZ	white tex
5144.N.1M.TR	white tex
5144.N.1M.ST	white tex
5144.N.2M.BZ	black tex
5144.N.2M.TR	black tex
5144.N.2M.ST	black tex

built-up



5146.P/.. - MANON

~230V  IP20        



built-up wall light - fixed - with E27 lampholder  
Wandleuchte für Aufbau - fest - mit E27 Fassung

**Lamp type**

 1x IT-32 E27 max. 8W  230V

**Dimensions**

 B125xH420xD185

 B60xH110xD25

Glass - Ø125xH315

**Materials**

aluminium 1M | 2M

**Ref**

5146.P.1M.BZ	white tex
5146.P.1M.TR	white tex
5146.P.1M.ST	white tex
5146.P.2M.BZ	black tex
5146.P.2M.TR	black tex
5146.P.2M.ST	black tex

built-up

5146.N/.. - MANON

~230V  IP20        





built-up wall light - fixed - with E27 lampholder  
Wandleuchte für Aufbau - fest - mit E27 Fassung

**Lamp type**

 1x A60 E27 max. 40W   230V

**Dimensions**

 B170xH280xD210

 B60xH110xD25

Glass - Ø170xH175

**Materials**

aluminium 1M | 2M

**Ref**

5146.N.1M.BZ	white tex
5146.N.1M.TR	white tex
5146.N.1M.ST	white tex
5146.N.2M.BZ	black tex
5146.N.2M.TR	black tex
5146.N.2M.ST	black tex

built-up

WALL UP

W780/.. - POLINA

~230V IP44 2,2800 0,5 m 05.20.02 CE



built-up wall light - glass H250  
Wandleuchte für Aufbau - Glas H250

Lamp type

1x A60 E27 max. 60W **A** - **E** 230V  
or 1x ST64 E27 max. 60W **A** - **E** 230V

Dimensions

Ø132xH300xD185  
Ø70xH30

Materials

INOX 48 | 32X | 46X | 64X | 31MX | 33MX  
red copper 30 | 56

Ref

W780.30 red copper  
W780.56 red copper shiny  
W780.31MX white texture  
W780.32X black texture  
W780.33MX brown texture  
W780.46X grey-brown  
W780.48 inox high gloss  
W780.64X black grey

built-up

W781/.. - POLINA

~230V IP44 2,3300 0,5 m 05.20.02 CE



built-up wall light - glass H320  
Wandleuchte für Aufbau - Glas H320

Lamp type

1x A60 E27 max. 60W **A** - **E** 230V  
or 1x ST64 E27 max. 60W **A** - **E** 230V

Dimensions

Ø132xH370xD185  
Ø70xH30

Materials

INOX 48 | 32X | 46X | 64X | 31MX | 33MX  
red copper 30 | 56

Ref

W781.30 red copper  
W781.56 red copper shiny  
W781.31MX white texture  
W781.32X black texture  
W781.33MX brown texture  
W781.46X grey-brown  
W781.48 inox high gloss  
W781.64X black grey

built-up

W782/.. - POLINA

~230V IP44 2,7850 0,5 m 05.20.02 CE



built-up wall light - glass H250  
Wandleuchte für Aufbau - Glas H250

Lamp type

1x A60 E27 max. 60W **A** - **E** 230V  
or 1x ST64 E27 max. 60W **A** - **E** 230V

Dimensions

Ø132xH320xD185  
B45xH320xD30

Materials

INOX 48 | 32X | 46X | 64X | 31MX | 33MX  
red copper 30 | 56

Ref

W782.30 red copper  
W782.56 red copper shiny  
W782.31MX white texture  
W782.32X black texture  
W782.33MX brown texture  
W782.46X grey-brown  
W782.48 inox high gloss  
W782.64X black grey

built-up

W783/.. - POLINA

~230V IP44 3,3950 0,5 m 05.20.02 CE



built-up wall light - glass H320  
Wandleuchte für Aufbau - Glas H320

Lamp type

1x A60 E27 max. 60W **A** - **E** 230V  
or 1x ST64 E27 max. 60W **A** - **E** 230V

Dimensions

Ø132xH400xD185  
B45xH400xD30

Materials

INOX 48 | 32X | 46X | 64X | 31MX | 33MX  
red copper 30 | 56

Ref

W783.30 red copper  
W783.56 red copper shiny  
W783.31MX white texture  
W783.32X black texture  
W783.33MX brown texture  
W783.46X grey-brown  
W783.48 inox high gloss  
W783.64X black grey

built-up

W785/.. - POLINA

~230V IP44 2,5900 0,5 m 05.20.02 CE



built-up wall light - glass H250  
Wandleuchte für Aufbau - Glas H250

Lamp type

1x A60 E27 max. 60W **A** - **E** 230V  
or 1x ST64 E27 max. 40W **A** - **E** 230V

Dimensions

Ø132xH300xD185  
Ø70xH30

Materials

INOX 48 | 32X | 46X | 64X | 31MX | 33MX  
red copper 30

Ref

W785.30	red copper
W785.31MX	white texture
W785.32X	black texture
W785.33MX	brown texture
W785.46X	grey-brown
W785.48	inox high gloss
W785.64X	black grey

built-up

W786/.. - POLINA

~230V IP44 0,5 m 05.20.02 CE



built-up wall light - glass H320  
Wandleuchte für Aufbau - Glas H320

Lamp type

1x A60 E27 max. 60W **A** - **E** 230V  
or 1x ST64 E27 max. 60W **A** - **E** 230V

Dimensions

Ø132xH370xD185  
Ø70xH30

Materials

INOX 48 | 32X | 46X | 64X | 31MX | 33MX  
red copper 30

Ref

W786.30	red copper
W786.31MX	white texture
W786.32X	black texture
W786.33MX	brown texture
W786.46X	grey-brown
W786.48	inox high gloss
W786.64X	black grey

built-up

W787/.. - POLINA

~230V IP44 3,1350 0,5 m 05.20.02 CE



built-up wall light - glass H250  
Wandleuchte für Aufbau - Glas H250

Lamp type

1x A60 E27 max. 60W **A** - **E** 230V  
or 1x ST64 E27 max. 40W **A** - **E** 230V

Dimensions

Ø132xH320xD185  
B45xH320xD30

Materials

INOX 48 | 32X | 46X | 64X | 31MX | 33MX  
red copper 30

Ref

W787.30	red copper
W787.31MX	white texture
W787.32X	black texture
W787.33MX	brown texture
W787.46X	grey-brown
W787.48	inox high gloss
W787.64X	black grey

built-up

W788/.. - POLINA

~230V IP44 0,5 m 05.20.02 CE



built-up wall light - glass H320  
Wandleuchte für Aufbau - Glas H320

Lamp type

1x A60 E27 max. 60W **A** - **E** 230V  
or 1x ST64 E27 max. 60W **A** - **E** 230V

Dimensions

Ø132xH400xD185  
B45xH400xD30

Materials

INOX 48 | 32X | 46X | 64X | 31MX | 33MX  
red copper 30

Ref

W788.30	red copper
W788.31MX	white texture
W788.32X	black texture
W788.33MX	brown texture
W788.46X	grey-brown
W788.48	inox high gloss
W788.64X	black grey

built-up









W730/.. - POLO

~230V IP44 1,4550 0,5 m 05.20.02 CE



built-up wall light  
Wandleuchte für Aufbau

Lamp type

1x C35 E14 max. 40W **A** - **E** 230V  
or 1x D45 E14 max. 40W **A** - **E** 230V

Dimensions

B80xH165xD100

Materials

INOX 32X | 46X | 53X | 64X | 31MX | 33MX  
INOX 316 5 | 5BB

Ref

W730.5	inox 316
W730.5BB	inox 316 2x coated
W730.31MX	white texture
W730.32X	black texture
W730.33MX	brown texture
W730.46X	grey-brown
W730.53X	bronze-brown
W730.64X	black grey

built-up

W731/.. - POLO

~230V IP44 1,9650 0,5 m 05.20.02 CE



built-up wall light  
Wandleuchte für Aufbau

Lamp type

1x C35 E14 max. 40W **A** - **E** 230V

Dimensions

B80xH250xD100

Materials

INOX 32X | 46X | 53X | 64X | 31MX | 33MX  
INOX 316 5 | 5BB

Ref

W731.5	inox 316
W731.5BB	inox 316 2x coated
W731.31MX	white texture
W731.32X	black texture
W731.33MX	brown texture
W731.46X	grey-brown
W731.53X	bronze-brown
W731.64X	black grey

built-up

W731.B/.. - POLO

~230V IP44 1,9450 0,5 m 05.20.02 CE



built-up wall light  
Wandleuchte für Aufbau

Lamp type

1x ST64 E27 max. 40W **A** - **E** 230V

Dimensions

B80xH250xD100

Materials

INOX 32X | 46X | 53X | 64X | 31MX | 33MX  
INOX 316 5 | 5BB

Ref

W731.B.5	inox 316
W731.B.5BB	inox 316 2x coated
W731.B.31MX	white texture
W731.B.32X	black texture
W731.B.33MX	brown texture
W731.B.46X	grey-brown
W731.B.53X	bronze-brown
W731.B.64X	black grey

built-up

W732/.. - POLO

~230V IP44 1,0600 0,5 m 05.20.02 CE



built-up wall light  
Wandleuchte für Aufbau

Lamp type

1x TCR-TSE GX53 max. 5W **A** - **E** 230V

Dimensions

B120xH120xD75

Materials

INOX 32X | 37X | 46X | 53X | 64X | 33MX  
INOX 316 5 | 5BB

Ref

W732.5	inox 316
W732.5BB	inox 316 2x coated
W732.32X	black texture
W732.33MX	brown texture
W732.37X	grey texture
W732.46X	grey-brown
W732.53X	bronze-brown
W732.64X	black grey

built-up

W733/.. - POLO

~230V



IP44



2,4550



0,5 m



05.20.02



built-up wall light  
Wandleuchte für Aufbau

Lamp type

1x A60 E27 max. 60W A - E 230V

or 1x ST64 E27 max. 60W A - E 230V

Dimensions

B128xH240xD128

Materials

INOX 32X | 46X | 53X | 64X | 31MX | 33MX  
INOX 316 5 | 5BB

Ref

W733.5	inox 316
W733.5BB	inox 316 2x coated
W733.31MX	white texture
W733.32X	black texture
W733.33MX	brown texture
W733.46X	grey-brown
W733.53X	bronze-brown
W733.64X	black grey

built-up

W733.S/.. - POLO

~230V



IP44



2,9400



0,5 m



05.20.02



built-up wall light - with built-in sensor  
Wandleuchte für Aufbau - mit eingebautem Sensor

Lamp type

1x A60 E27 max. 60W A - E 230V

or 1x ST64 E27 max. 60W A - E 230V

Dimensions

B128xH285xD128

Materials

INOX 32X | 46X | 53X | 64X | 31MX | 33MX  
INOX 316 5 | 5BB

Ref

W733.S.5	inox 316
W733.S.5BB	inox 316 2x coated
W733.S.31MX	white texture
W733.S.32X	black texture
W733.S.33MX	brown texture
W733.S.46X	grey-brown
W733.S.53X	bronze-brown
W733.S.64X	black grey

built-up

W734/.. - POLO

~230V



IP44



3,0250



0,5 m



05.20.02



built-up wall light  
Wandleuchte für Aufbau

Lamp type

1x A60 E27 max. 60W A - E 230V

or 1x ST64 E27 max. 60W A - E 230V

Dimensions

B128xH320xD128

Materials

Cortenstaal 54  
INOX 32X | 46X | 53X | 64X | 31MX | 33MX  
INOX 316 5 | 5BB

Ref

W734.5	inox 316
W734.5BB	inox 316 2x coated
W734.54	corten steel
W734.31MX	white texture
W734.32X	black texture
W734.33MX	brown texture
W734.46X	grey-brown
W734.53X	bronze-brown
W734.64X	black grey

built-up

W734.S/.. - POLO

~230V



IP44



3,5500



0,5 m



05.20.02

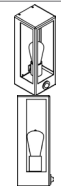

built-up wall light - with built-in sensor  
Wandleuchte für Aufbau - mit eingebautem Sensor

Lamp type

1x A60 E27 max. 60W A - E 230V

or 1x ST64 E27 max. 60W A - E 230V

Dimensions

B128xH365xD128

Materials

INOX 32X | 46X | 53X | 64X | 31MX | 33MX  
INOX 316 5 | 5BB

Ref

W734.S.5	inox 316
W734.S.5BB	inox 316 2x coated
W734.S.31MX	white texture
W734.S.32X	black texture
W734.S.33MX	brown texture
W734.S.46X	grey-brown
W734.S.53X	bronze-brown
W734.S.64X	black grey

built-up









W735/.. - POLO

~230V IP44 3,8350 0,5 m 05.20.02 CE



built-up wall light  
Wandleuchte für Aufbau

Lamp type

1x A60 E27 max. 60W A - E 230V

or 1x ST64 E27 max. 60W A - E 230V

Dimensions

B128xH440xD128

Materials

INOX 32X | 46X | 53X | 64X | 31MX | 33MX  
INOX 316 5 | 5BB

Ref

W735.5	inox 316
W735.5BB	inox 316 2x coated
W735.31MX	white texture
W735.32X	black texture
W735.33MX	brown texture
W735.46X	grey-brown
W735.53X	bronze-brown
W735.64X	black grey

built-up

W1171/.. - POLO

~230V IP44 3,8600 0,5 m 05.20.02 CE



built-up wall light  
Wandleuchte für Aufbau

Lamp type

2x A60 E27 max. 60W A - E 230V

or 2x ST64 E27 max. 60W A - E 230V

Dimensions

B128xH440xD128

Materials

INOX 32X | 46X | 53X | 31MX  
INOX 316 5 | 5BB

Ref

W1171.5	inox 316
W1171.5BB	inox 316 2x coated
W1171.31MX	white texture
W1171.32X	black texture
W1171.46X	grey-brown
W1171.53X	bronze-brown

built-up

W736/.. - POLO

~230V IP44 3,8600 0,5 m 05.20.02 CE



built-up wall light  
Wandleuchte für Aufbau

Lamp type

1x A60 E27 max. 60W A - E 230V

or 1x ST64 E27 max. 60W A - E 230V

Dimensions

B240xH240xD128

Materials

INOX 32X | 46X | 53X | 64X | 31MX | 33MX  
INOX 316 5 | 5BB

Ref

W736.5	inox 316
W736.5BB	inox 316 2x coated
W736.31MX	white texture
W736.32X	black texture
W736.33MX	brown texture
W736.46X	grey-brown
W736.53X	bronze-brown
W736.64X	black grey

built-up

W737/.. - POLO

~230V IP44 4,7100 0,5 m 05.20.02



built-up wall light  
Wandleuchte für Aufbau

Lamp type

1x A60 E27 max. 60W **A** - **E** 230V  
or 1x ST64 E27 max. 60W **A** - **E** 230V

Dimensions

B240xH320xD128

Materials

INOX 32X | 46X | 53X | 64X | 31MX | 33MX  
INOX 316 5 | 5BB

Ref

W737.5	inox 316
W737.5BB	inox 316 2x coated
W737.31MX	white texture
W737.32X	black texture
W737.33MX	brown texture
W737.46X	grey-brown
W737.53X	bronze-brown
W737.64X	black grey

built-up

W737.B/.. - POLO

~230V IP44 4,8500 0,5 m 05.20.02



built-up wall light  
Wandleuchte für Aufbau

Lamp type

2x A60 E27 max. 60W **A** - **E** 230V  
or 2x ST64 E27 max. 60W **A** - **E** 230V

Dimensions

B240xH320xD128

Materials

INOX 32X | 46X | 53X | 64X | 31MX | 33MX  
INOX 316 5 | 5BB

Ref

W737.B.5	inox 316
W737.B.5BB	inox 316 2x coated
W737.B.31MX	white texture
W737.B.32X	black texture
W737.B.33MX	brown texture
W737.B.46X	grey-brown
W737.B.53X	bronze-brown
W737.B.64X	black grey

built-up

W738/.. - POLO

~230V IP44 5,6900 0,5 m 05.20.02



built-up wall light  
Wandleuchte für Aufbau

Lamp type

1x A60 E27 max. 60W **A** - **E** 230V  
or 1x ST64 E27 max. 60W **A** - **E** 230V

Dimensions

B320xH320xD128

Materials

INOX 32X | 46X | 53X | 64X | 31MX | 33MX  
INOX 316 5 | 5BB

Ref

W738.5	inox 316
W738.5BB	inox 316 2x coated
W738.31MX	white texture
W738.32X	black texture
W738.33MX	brown texture
W738.46X	grey-brown
W738.53X	bronze-brown
W738.64X	black grey

built-up

W738.B/.. - POLO

~230V IP44 5,6450 0,5 m 05.20.02



built-up wall light  
Wandleuchte für Aufbau

Lamp type

2x A60 E27 max. 60W **A** - **E** 230V  
or 2x ST64 E27 max. 60W **A** - **E** 230V

Dimensions

B320xH320xD128

Materials

INOX 32X | 46X | 53X | 64X | 31MX | 33MX  
INOX 316 5 | 5BB

Ref

W738.B.5	inox 316
W738.B.5BB	inox 316 2x coated
W738.B.31MX	white texture
W738.B.32X	black texture
W738.B.33MX	brown texture
W738.B.46X	grey-brown
W738.B.53X	bronze-brown
W738.B.64X	black grey

built-up

W772/.. - POLO

~230V IP44 2,1550 0,5 m 05.20.02



built-up wall light  
Wandleuchte für Aufbau

Lamp type

1x C35 E14 max. 40W **A** - **E** 230V

Dimensions

B136xH220xD200

B60xH60xD30

Head - L136xB136xH180

Materials

INOX 32X | 46X | 53X | 64X | 31MX | 33MX  
INOX 316 5 | 5BB

Ref

W772.5	inox 316
W772.5BB	inox 316 2x coated
W772.31MX	white texture
W772.32X	black texture
W772.33MX	brown texture
W772.46X	grey-brown
W772.53X	bronze-brown
W772.64X	black grey

built-up

W772.B/.. - POLO

~230V IP44 2,0400 0,5 m 05.20.02



built-up wall light  
Wandleuchte für Aufbau

Lamp type

1x A60 E27 max. 40W **A** - **E** 230V

Dimensions

B136xH220xD200

B60xH60xD30

Head - L136xB136xH180

Materials

INOX 32X | 46X | 53X | 64X | 31MX | 33MX  
INOX 316 5 | 5BB

Ref

W772.B.5	inox 316
W772.B.5BB	inox 316 2x coated
W772.B.31MX	white texture
W772.B.32X	black texture
W772.B.33MX	brown texture
W772.B.46X	grey-brown
W772.B.53X	bronze-brown
W772.B.64X	black grey

built-up

W773/.. - POLO

~230V IP44 2,0100 0,5 m 05.20.02



built-up wall light  
Wandleuchte für Aufbau

Lamp type

1x QPAR 51 GU10 max. 20W **A** - **E** 230V

Dimensions

B136xH220xD200

B60xH60xD30

Head - L136xB136xH180

Materials

INOX 32X | 46X | 53X | 64X | 31MX | 33MX  
INOX 316 5 | 5BB

Ref

W773.5	inox 316
W773.5BB	inox 316 2x coated
W773.31MX	white texture
W773.32X	black texture
W773.33MX	brown texture
W773.46X	grey-brown
W773.53X	bronze-brown
W773.64X	black grey

built-up

W750/.. - POLO

~230V IP44 3,7750 0,5 m 05.20.02



built-up wall light  
Wandleuchte für Aufbau

Lamp type

1x A60 E27 max. 60W **A** - **E** 230V

or 1x ST64 E27 max. 60W **A** - **E** 230V

Dimensions

B128xH380xD190

B110xH110xD30

Head - L128xB128xH320

Options

T1184 - POLO ZUIL

Materials

INOX 32X | 46X | 53X | 64X | 31MX | 33MX  
INOX 316 5 | 5BB

Ref

W750.5	inox 316
W750.5BB	inox 316 2x coated
W750.31MX	white texture
W750.32X	black texture
W750.33MX	brown texture
W750.46X	grey-brown
W750.53X	bronze-brown
W750.64X	black grey

built-up



W751/.. - POLO

~230V IP44 5,7500 0,5 m 05.20.02



built-up wall light  
Wandleuchte für Aufbau

Lamp type

1x A60 E27 max. 60W **A** - **E** 230V  
or 1x ST64 E27 max. 60W **A** - **E** 230V

Dimensions

B220xH380xD330  
B110xH110xD30  
Head - L240xB220xH320

Options

T1184 - POLO ZUIL

Materials

INOX 32X | 46X | 53X | 64X | 31MX | 33MX  
INOX 316 5 | 5BB

Ref

W751.5 inox 316  
W751.5BB inox 316 2x coated  
W751.31MX white texture  
W751.32X black texture  
W751.33MX brown texture  
W751.46X grey-brown  
W751.53X bronze-brown  
W751.64X black grey

built-up

W752/.. - POLO

~230V IP44 7,9050 0,5 m 05.20.02



built-up wall light  
Wandleuchte für Aufbau

Lamp type

1x A60 E27 max. 60W **A** - **E** 230V  
or 1x ST64 E27 max. 60W **A** - **E** 230V

Dimensions

B220xH500xD280  
B110xH110xD30  
Head - L240xB220xH440

Options

T1184 - POLO ZUIL

Materials

INOX 32X | 46X | 53X | 64X | 31MX | 33MX  
INOX 316 5 | 5BB

Ref

W752.5 inox 316  
W752.5BB inox 316 2x coated  
W752.31MX white texture  
W752.32X black texture  
W752.33MX brown texture  
W752.46X grey-brown  
W752.53X bronze-brown  
W752.64X black grey

built-up

W753/.. - POLO

~230V IP44 6,3600 0,5 m 05.20.02



built-up wall light  
Wandleuchte für Aufbau

Lamp type

1x A60 E27 max. 60W **A** - **E** 230V  
or 1x ST64 E27 max. 60W **A** - **E** 230V

Dimensions

B345xH380xD360  
B110xH110xD30  
Head - L300xB300xH320

Options

T1184 - POLO ZUIL

Materials

INOX 32X | 46X | 53X | 64X | 31MX | 33MX  
INOX 316 5 | 5BB

Ref

W753.5 inox 316  
W753.5BB inox 316 2x coated  
W753.31MX white texture  
W753.32X black texture  
W753.33MX brown texture  
W753.46X grey-brown  
W753.53X bronze-brown  
W753.64X black grey

built-up

W753.B/.. - POLO

~230V IP44 6,3600 0,5 m 05.20.02



built-up wall light  
Wandleuchte für Aufbau

Lamp type

2x A60 E27 max. 60W **A** - **E** 230V  
or 2x ST64 E27 max. 60W **A** - **E** 230V

Dimensions

B345xH380xD360  
B110xH110xD30  
Head - L300xB300xH320

Options

T1184 - POLO ZUIL

Materials

INOX 32X | 46X | 53X | 64X | 31MX | 33MX  
INOX 316 5 | 5BB

Ref

W753.B.5 inox 316  
W753.B.5BB inox 316 2x coated  
W753.B.31MX white texture  
W753.B.32X black texture  
W753.B.33MX brown texture  
W753.B.46X grey-brown  
W753.B.53X bronze-brown  
W753.B.64X black grey

built-up

WALL UP

W770/.. - POLO

~230V IP44 1,4700 0,5 m 05.20.02 CE



built-up wall light  
Wandleuchte für Aufbau

Lamp type

1x C35 E14 max. 40W **A** - **E** 230V

Dimensions

B160xH200xD200

B60xH60xD30

Head - L160xB160xH160

Materials

INOX 32X | 46X | 53X | 64X | 31MX | 33MX  
INOX 316 5 | 5BB

Ref

W770.5	inox 316
W770.5BB	inox 316 2x coated
W770.31MX	white texture
W770.32X	black texture
W770.33MX	brown texture
W770.46X	grey-brown
W770.53X	bronze-brown
W770.64X	black grey

built-up

W770.B/.. - POLO

~230V IP44 1,5000 0,5 m 05.20.02 CE



built-up wall light  
Wandleuchte für Aufbau

Lamp type

1x A60 E27 max. 40W **A** - **E** 230V

Dimensions

B160xH200xD200

B60xH60xD30

Head - L160xB160xH160

Materials

INOX 32X | 46X | 53X | 64X | 31MX | 33MX  
INOX 316 5 | 5BB

Ref

W770.B.5	inox 316
W770.B.5BB	inox 316 2x coated
W770.B.31MX	white texture
W770.B.32X	black texture
W770.B.33MX	brown texture
W770.B.46X	grey-brown
W770.B.53X	bronze-brown
W770.B.64X	black grey

built-up

W771/.. - POLO

~230V IP44 1,6200 0,5 m 05.20.02 CE



built-up wall light  
Wandleuchte für Aufbau

Lamp type

1x QPAR 51 GU10 max. 20W **A** - **E** 230V

or 1x QPAR70 GU10 max. 7W **A** 230V

Dimensions

B160xH200xD200

B60xH60xD30

Head - L160xB160xH160

Materials

INOX 32X | 46X | 53X | 64X | 31MX | 33MX  
INOX 316 5 | 5BB

Ref

W771.5	inox 316
W771.5BB	inox 316 2x coated
W771.31MX	white texture
W771.32X	black texture
W771.33MX	brown texture
W771.46X	grey-brown
W771.53X	bronze-brown
W771.64X	black grey

built-up

W754/.. - POLO

~230V IP44 4,8200 0,5 m 05.20.02 CE



built-up wall light  
Wandleuchte für Aufbau

Lamp type

1x A60 E27 max. 60W **A** - **E** 230V

or 1x ST64 E27 max. 60W **A** - **E** 230V

Dimensions

B240xH380xD320

B110xH110xD30

Head - L240xB240xH320

Options

T1184 - POLO ZUIL

Materials

INOX 32X | 46X | 53X | 64X | 31MX | 33MX  
INOX 316 5 | 5BB

Ref

W754.5	inox 316
W754.5BB	inox 316 2x coated
W754.31MX	white texture
W754.32X	black texture
W754.33MX	brown texture
W754.46X	grey-brown
W754.53X	bronze-brown
W754.64X	black grey

built-up

W777/.. - POLO

~230V



built-up wall light  
Wandleuchte für Aufbau

Lamp type

1x ST64 E27 max. 40W A - E 230V

or 1x G95 E27 max. 40W A - E 230V

Dimensions

B240xH320xD300

B90xH90xD30

Head - L240xB240xH240

Materials

INOX 32X | 46X | 53X | 64X | 31MX | 33MX

INOX 316 5 | 5BB

Ref

W777.5	inox 316
W777.5BB	inox 316 2x coated
W777.31MX	white texture
W777.32X	black texture
W777.33MX	brown texture
W777.46X	grey-brown
W777.53X	bronze-brown
W777.64X	black grey

built-up

W755/.. - POLO

~230V



built-up wall light  
Wandleuchte für Aufbau

Lamp type

1x G95 E27 max. 60W A - E 230V

or 1x ST64 E27 max. 60W A - E 230V

Dimensions

B320xH390xD365

B110xH110xD30

Head - L320xB320xH320

Options

T1184 - POLO ZUIL

Materials

INOX 32X | 46X | 53X | 64X | 31MX | 33MX

INOX 316 5 | 5BB

Ref

W755.5	inox 316
W755.5BB	inox 316 2x coated
W755.31MX	white texture
W755.32X	black texture
W755.33MX	brown texture
W755.46X	grey-brown
W755.53X	bronze-brown
W755.64X	black grey

built-up

**W756/.. - POLO**

~230V  IP44    8,2800 0,5 m 05.20.02 



built-up wall light  
Wandleuchte für Aufbau

**Lamp type**

1x G95 E27 max. 60W  230V  
or 1x ST64 E27 max. 60W  230V

**Dimensions**

B400xH470xD460  
B110xH110xD30  
Head - L400xB400xH400

**Materials**

INOX 32X | 46X | 53X | 64X | 31MX | 33MX  
INOX 316 5 | 5BB

**Ref**

W756.5	inox 316
W756.5BB	inox 316 2x coated
W756.31MX	white texture
W756.32X	black texture
W756.33MX	brown texture
W756.46X	grey-brown
W756.53X	bronze-brown
W756.64X	black grey

built-up

**W757/.. - POLO**

~230V  IP44    8,2800 0,5 m 05.20.50 



built-up wall light - with Xicato LED IP66 - with LED driver  
Wandleuchte für Aufbau - mit LED-Modul Xicato IP66 - mit Driver LED

**Lamp type**

1x Led 2220lm CRI80 max. 29W  700mA

**Dimensions**



B400xH470xD460  
B110xH110xD30  
Head - L400xB400xH400

**Ref**

W757.5	NW
W757.5BB	NW
W757.31MX	NW
W757.32X	NW
W757.33MX	NW
W757.46X	NW
W757.53X	NW
W757.64X	NW

built-up  
other LED colours on request  
andere LED-Farben auf Anfrage

**W757B/.. - POLO**

~230V  IP44    8,2800 0,5 m 05.20.50 



built-up wall light - with Xicato LED IP66 - with LED driver  
Wandleuchte für Aufbau - mit LED-Modul Xicato IP66 - mit Driver LED

**Lamp type**

1x Led 2220lm CRI80 max. 29W  700mA

**Dimensions**

B600xH670xD660  
B110xH110xD30  
Head - L600xB600xH600

**Ref**

W757B.5	NW
W757B.5BB	NW
W757B.31MX	NW
W757B.32X	NW
W757B.33MX	NW
W757B.46X	NW
W757B.53X	NW
W757B.64X	NW

built-up  
other LED colours on request  
andere LED-Farben auf Anfrage



W1190/.. - POLO

~230V IP44 2,8000 0,5 m 05.20.02 CE



built-up wall light  
Wandleuchte für Aufbau

Lamp type

1x A60 E27 max. 40W A E 230V

or 1x ST64 E27 max. 40W A E 230V

Dimensions

B128xH320xD128

Materials

INOX 32X | 46X | 53X | 64X | 31MX | 33MX  
INOX 316 5BB

Ref

W1190.5BB	inox 316 2x coated
W1190.31MX	white texture
W1190.32X	black texture
W1190.33MX	brown texture
W1190.46X	grey-brown
W1190.53X	bronze-brown
W1190.64X	black grey

built-up

W1191/.. - POLO

~230V IP44 4,6800 0,5 m 05.20.02 CE



built-up wall light  
Wandleuchte für Aufbau

Lamp type

1x A60 E27 max. 40W A E 230V

or 1x ST64 E27 max. 40W A E 230V

Dimensions

B240xH320xD128

Materials

INOX 32X | 46X | 53X | 64X | 31MX | 33MX  
INOX 316 5BB

Ref

W1191.5BB	inox 316 2x coated
W1191.31MX	white texture
W1191.32X	black texture
W1191.33MX	brown texture
W1191.46X	grey-brown
W1191.53X	bronze-brown
W1191.64X	black grey

built-up

W1191.B/.. - POLO

~230V IP44 4,6800 0,5 m 05.20.02 CE



built-up wall light  
Wandleuchte für Aufbau

Lamp type

2x A60 E27 max. 40W A E 230V

or 2x ST64 E27 max. 40W A E 230V

Dimensions

B240xH320xD128

Materials

INOX 32X | 46X | 53X | 64X | 31MX | 33MX  
INOX 316 5BB

Ref

W1191.B.5BB	inox 316 2x coated
W1191.B.31MX	white texture
W1191.B.32X	black texture
W1191.B.33MX	brown texture
W1191.B.46X	grey-brown
W1191.B.53X	bronze-brown
W1191.B.64X	black grey

built-up

W1192/.. - POLO

~230V IP44 2,7000 0,5 m 05.20.02 CE



built-up wall light  
Wandleuchte für Aufbau

Lamp type

1x A60 E27 max. 40W A E 230V

or 1x ST64 E27 max. 40W A E 230V

Dimensions

B180xH320xD150

Materials

INOX 32X | 46X | 53X | 64X | 31MX | 33MX  
INOX 316 5BB

Ref

W1192.5BB	inox 316 2x coated
W1192.31MX	white texture
W1192.32X	black texture
W1192.33MX	brown texture
W1192.46X	grey-brown
W1192.53X	bronze-brown
W1192.64X	black grey

built-up

WALL UP

W1193/.. - POLO

~230V



IP44



4,2200

0,5 m

05.20.02



built-up wall light  
Wandleuchte für Aufbau

Lamp type

1x A60 E27 max. 40W A - E 230V

1x ST64 E27 max. 40W A - E 230V

Dimensions

B240xH320xD150

Materials

INOX 32X | 46X | 53X | 64X | 31MX | 33MX

INOX 316 5BB

Ref

W1193.5BB	inox 316 2x coated
W1193.31MX	white texture
W1193.32X	black texture
W1193.33MX	brown texture
W1193.46X	grey-brown
W1193.53X	bronze-brown
W1193.64X	black grey

built-up

W1194/.. - POLO

~230V



IP44



3,6900

0,5 m

05.20.02



built-up wall light  
Wandleuchte für Aufbau

Lamp type

1x A60 E27 max. 40W A - E 230V

1x ST64 E27 max. 40W A - E 230V

Dimensions

B128xH320xD128

Materials

INOX 32X | 46X | 53X | 64X | 31MX | 33MX

INOX 316 5BB

Ref

W1194.5BB	inox 316 2x coated
W1194.31MX	white texture
W1194.32X	black texture
W1194.33MX	brown texture
W1194.46X	grey-brown
W1194.53X	bronze-brown
W1194.64X	black grey

built-up

5530.B/.. - SHAKE GLASS

~230V  IP20      0.5 m  05.20.02  CE



built-up wall light - fixed - with E27 lampholder  
Wandleuchte für Aufbau - fest - mit E27 Fassung

**Lamp type**

1x A60 E27 max. 28W  230V

**Dimensions**

B150xH180xD175

Base - B50xH70xD120

Glass - Ø150xH110

**Materials**

aluminium 1M | 2M

**Ref**

5530.B.1M.TR	white tex
5530.B.1M.ST	white tex
5530.B.2M.TR	black tex
5530.B.2M.ST	black tex

built-up

5531.B/.. - SHAKE GLASS

~230V  IP20      0.5 m  05.20.02  CE



built-up wall light - fixed - with E27 lampholder  
Wandleuchte für Aufbau - fest - mit E27 Fassung

**Lamp type**

1x A60 E27 max. 40W  230V

**Dimensions**

B150xH210xD200

L60xB110xH25

Glass - Ø150xH110

**Materials**

aluminium 1M | 2M

**Ref**

5531.B.1M.TR	white tex
5531.B.1M.ST	white tex
5531.B.2M.TR	black tex
5531.B.2M.ST	black tex

built-up

5531.A/.. - SHAKE GLASS

~230V  IP20      0.5 m  05.20.02  CE



built-up wall light - fixed - with E27 lampholder  
Wandleuchte für Aufbau - fest - mit E27 Fassung

**Lamp type**

1x A60 E27 max. 40W  230V

**Dimensions**

B180xH300xD215

B60xH110xD25

Glass - Ø180xH200

**Materials**

aluminium 1M | 2M

**Ref**

5531.A.1M.TR	white tex
5531.A.1M.ST	white tex
5531.A.2M.TR	black tex
5531.A.2M.ST	black tex

built-up

5533.B/.. - SHAKE METAL

~230V IP20 0,5 m 05.20.02 CE



built-up wall light - fixed - with E27 lampholder  
Wandleuchte für Aufbau - fest - mit E27 Fassung

Lamp type

1x A60 E27 max. 28W A - E 230V

Dimensions

B160xH180xD180

Base - B50xH70xD120

Cone - Ø160xH110

Materials

aluminium 1M | 2M  
aluminium / red copper 282

Ref

5533.B.1M white tex  
5533.B.2M black tex  
5533.B.162 black - matte gold  
5533.B.282 red copper - black

built-up

5534.B/.. - SHAKE METAL

~230V IP20 0,5 m 05.20.02 CE



built-up wall light - fixed - with E27 lampholder  
Wandleuchte für Aufbau - fest - mit E27 Fassung

Lamp type

1x A60 E27 max. 40W A - E 230V

Dimensions

B160xH220xD205

B60xH110xD25

Cone - Ø160xH110

Materials

aluminium 1M | 2M  
aluminium / red copper 282

Ref

5534.B.1M white tex  
5534.B.2M black tex  
5534.B.162 black - matte gold  
5534.B.282 red copper - black

built-up

5534.A/.. - SHAKE METAL

~230V IP20 0,5 m 05.20.02 CE



built-up wall light - fixed - with E27 lampholder  
Wandleuchte für Aufbau - fest - mit E27 Fassung

Lamp type

1x A60 E27 max. 40W A - E 230V

Dimensions

B180xH300xD215

B60xH110xD25

Cone - Ø180xH200

Materials

aluminium 1M | 2M  
aluminium / red copper 282

Ref

5534.A.1M white tex  
5534.A.2M black tex  
5534.A.162 black - matte gold  
5534.A.282 red copper - black

built-up



3408/.. - CLARA

~230V



built-up wall light - fixed - down/up  
Wandleuchte für Aufbau - fest - down/up

**Lamp type**

2x QPAR 51 GU10 max. 20W A+ - E **230V**

**Dimensions**

Ø75xH150

Base - Ø54xH32

**Materials**

aluminium **14 | 1M | 29 | 2M**

red copper **28**

**Ref**

3408.1M	white tex
3408.2M	black tex
3408.14	alu satin
3408.28	rosé
3408.29	black - gold inside

built-up

W3409/.. - CLARA

~230V



built-up wall light - fixed - down/up  
Wandleuchte für Aufbau - fest - down/up

**Lamp type**

2x QPAR 51 GU10 max. 20W A+ - E **230V**

**Dimensions**

Ø75xH150

Base - Ø54xH32

**Materials**

ALU ANODISE **32A | 37A | 46A | 31MA**

red copper **30**

**Ref**

W3409.30	red copper
W3409.31MA	white texture ano
W3409.32A	black texture ano
W3409.37A	grey text ano
W3409.46A	grey-brown ano

built-up

WALL UP



3044.LED/.. - ARC LED

~230V



IP20



built-up wall light - down/up  
Wandleuchte für Aufbau - down/up

**Lamp type**

2x 21LED L 1000lm CRI80 max. 8W A+ 230V

**Dimensions**

B162xH410xD65

**Materials**

aluminium 1M | 40

**Ref**

3044.LED.1M.NW

white tex

3044.LED.40.NW

anodised alu

built-up

4036/.. - KOBUS

~230V



built-up wall light - round - fixed - down/up  
Wandleuchte für Aufbau - rund - fest - down/up

Lamp type

1x QT14 G9 max. 20W A - E 230V

Dimensions

Ø100xH100  
Base - Ø60xH25

Materials

aluminium 1M | 29 | 2M | 49

Ref

4036.1M	white tex
4036.2M	black tex
4036.29	black - gold inside
4036.49	white - gold inside

built-up

4029/.. - KOBUS

~230V



built-up wall light - square - fixed - down/up  
Wandleuchte für Aufbau - viereckig - fest - down/up

Lamp type

1x QT14 G9 max. 33W A - E 230V

Dimensions

B100xH100xD125  
B60xH60xD25

Materials

aluminium 1M | 29 | 2M | 49

Ref

4029.1M	white tex
4029.2M	black tex
4029.29	black - gold inside
4029.49	white - gold inside

built-up

4029.2/.. - KOBUS

~230V



built-up wall light - fixed - down/up  
Wandleuchte für Aufbau - fest - down/up

Lamp type

2x QT14 G9 max. 20W A - E 230V

Dimensions

B235xH100xD125  
B155xH40xD20

Materials

aluminium 1M | 29 | 2M | 49

Ref

4029.2.1M	white tex
4029.2.2M	black tex
4029.2.29	black - gold inside
4029.2.49	white - gold inside

built-up

4032/.. - KOBUS

~230V



built-up wall light - square - fixed - down/up  
Wandleuchte für Aufbau - viereckig - fest - down/up

Lamp type

2x TCR-TSE GX53 max. 11W A+ - E 230V

Dimensions

B100xH100xD125  
B60xH60xD25

Materials

aluminium 1M | 29 | 2M | 49

Ref

4032.1M	white tex
4032.2M	black tex
4032.29	black - gold inside
4032.49	white - gold inside

built-up

4032.2/.. - KOBUS

~230V

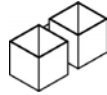

built-up wall light - fixed - down/up  
Wandleuchte für Aufbau - fest - down/up

**Lamp type**

4x TCR-TSE GX53 max. 11W 230V

**Dimensions**

B235xH100xD125

B155xH40xD20

**Materials**

aluminium 1M | 29 | 2M | 49

**Ref**

4032.2.1M

white tex

4032.2.2M

black tex

4032.2.29

black - gold inside

4032.2.49

white - gold inside

built-up



WALL UP



4034/.. - KOBUS

~230V



built-up wall light - fixed - down/up  
Wandleuchte für Aufbau - fest - down/up

Lamp type

2x QPAR 51 GU10 max. 20W A+ - E 230V

Dimensions

B80xH150xD105

B60xH60xD25

Materials

aluminium 1M | 2M

Ref

4034.1M white tex  
4034.2M black tex

built-up

4034.2/.. - KOBUS

~230V



built-up wall light - fixed - down/up  
Wandleuchte für Aufbau - fest - down/up

Lamp type

4x QPAR 51 GU10 max. 20W A+ - E 230V

Dimensions

B195xH150xD105

B155xH40xD20

Materials

aluminium 1M | 2M

Ref

4034.2.1M white tex  
4034.2.2M black tex

built-up

4035/.. - KOBUS

~230V



built-up wall light - down/up - with LED driver  
Wandleuchte für Aufbau - down/up - mit Driver LED

Lamp type

2x Led 1300lm CRI80 max. 9,5W A+ - A+ 700mA

Dimensions

B100xH150xD122  $\wedge$  40° reflector

B100xH150xD40

Materials

aluminium 1M | 2M

Ref

4035.1M.NW white tex  
4035.1M.WW white tex  
4035.2M.NW black tex  
4035.2M.WW black tex

built-up  
leds included  
Leds einbegriffen



1750.ES50/.. - BETAPLUS

~230V



built-up wall light - square - fixed - down  
Wandleuchte für Aufbau - viereckig - fest - down

Lamp type

1x QPAR 51 GU10 max. 20W **A+** - **E** 230V

Dimensions

B90xH100xD115  
L60xB60

Materials

aluminium 14 | 1M | 2M | 11M

Ref

1750.ES50.1M	white tex
1750.ES50.2M	black tex
1750.ES50.11M	grey tex
1750.ES50.14.5	alu satin

built-up

1750.ES63/.. - BETAPLUS

~230V



built-up wall light - square - fixed - down  
Wandleuchte für Aufbau - viereckig - fest - down

Lamp type

1x QPAR64 GU10 max. 75W **A+** - **D** 230V

Dimensions

B90xH100xD115  
L60xB60

Materials

aluminium 14 | 1M | 2M | 11M

Ref

1750.ES63.1M	white tex
1750.ES63.2M	black tex
1750.ES63.11M	grey tex
1750.ES63.14.5	alu satin

built-up

1751.ES50/.. - BETAPLUS

~230V



built-up wall light - square - directional - down  
Wandleuchte für Aufbau - viereckig - schwenkbar - down

Lamp type

1x QPAR 51 GU10 max. 20W **A+** - **E** 230V

Dimensions

B90xH100xD115  
L60xB60

Materials

aluminium 14 | 1M | 2M | 11M

Ref

1751.ES50.1M	white tex
1751.ES50.2M	black tex
1751.ES50.2M.22	black tex
1751.ES50.11M	grey tex
1751.ES50.14.11	alu satin

built-up

1752.ES50/.. - BETAPLUS

~230V

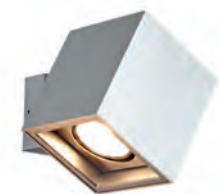

built-up wall light - square - down - luminaire directional -  
cassette fix  
Wandleuchte für Aufbau - viereckig - down - Leuchte  
schwenkbar - Kassette fest

Lamp type

1x QPAR 51 GU10 max. 20W **A+** - **E** 230V

Dimensions

B90xH100xD115  
L60xB60

Materials

aluminium 14 | 1M | 2M | 11M

Ref

1752.ES50.1M	white tex
1752.ES50.2M	black tex
1752.ES50.11M	grey tex
1752.ES50.14.5	alu satin

built-up  
directional cassette on request  
drehbare Kassette auf Anfrage



1754.ES50/.. - BETAPLUS

~230V



built-up wall light - square - fixed - down  
Wandleuchte für Aufbau - viereckig - fest - down

**Lamp type**

2x QPAR 51 GU10 max. 20W A+ - E 230V

**Dimensions**

B162xH100xD115

L60xB60

**Materials**

aluminium 14 | 1M | 2M | 11M

**Ref**

1754.ES50.1M	white tex
1754.ES50.2M	black tex
1754.ES50.11M	grey tex
1754.ES50.14.5	alu satin

built-up

1755.ES50/.. - BETAPLUS

~230V



built-up wall light - square - directional - down  
Wandleuchte für Aufbau - viereckig - schwenkbar - down

**Lamp type**

2x QPAR 51 GU10 max. 20W A+ - E 230V

**Dimensions**

B162xH100xD115

L60xB60

**Materials**

aluminium 14 | 1M | 2M | 11M

**Ref**

1755.ES50.1M	white tex
1755.ES50.2M	black tex
1755.ES50.11M	grey tex
1755.ES50.14.11	alu satin

built-up



1753.ES50/.. - BETAPLUS

~230V  IP20    0,9500  1 m  05.20.02 



built-up wall light - square - fixed - down - with glass  
Wandleuchte für Aufbau - viereckig - fest - down - mit Glas

**Lamp type**  
1x QPAR 51 GU10 max. 20W  230V







**Dimensions**  
B90xH100xD115  
L60xB60

**Materials**  
aluminium 14 | 1M | 2M | 11M

Ref	
1753.ES50.1M	white tex
1753.ES50.2M	black tex
1753.ES50.11M	grey tex
1753.ES50.14.5	alu satin

built-up

1756.ES50/.. - BETAPLUS

~230V  IP20    1 m  05.20.02 



built-up wall light - square - fixed - down - with glass  
Wandleuchte für Aufbau - viereckig - fest - down - mit Glas

**Lamp type**  
2x QPAR 51 GU10 max. 20W  230V







**Dimensions**  
B162xH100xD115  
L60xB60

**Materials**  
aluminium 14 | 1M | 2M | 11M

Ref	
1756.ES50.1M	white tex
1756.ES50.2M	black tex
1756.ES50.11M	grey tex
1756.ES50.14.5	alu satin

built-up

1717.TCDE/.. - BETAPLUS

~230V  IP20    1,9200  0,5 m  05.20.50 



built-up wall light - square - fixed - down - with glass - with electronic gear  
Wandleuchte für Aufbau - viereckig - fest - down - mit Glas - mit elektronischem Vorschaltgerät

**Lamp type**  
1x TC-DEL G24Q-2 max. 18W  230V

**Dimensions**  
B232xH110xD115  
L60xB60

**Materials**  
aluminium 1M | 2M | 11M

Ref	
1717.TCDE.1M	white tex
1717.TCDE.2M	black tex
1717.TCDE.11M	grey tex

built-up

1600/.. - LARA

~230V IP20 0,4600 1 m 05.20.02 CE



built-up wall light - square - fixed - up - with glass  
Wandleuchte für Aufbau - viereckig - fest - up - mit Glas

Lamp type

1x QT14 G9 max. 25W A - E 230V

Dimensions

B80xH80xD80

L80xB80

Materials

aluminium 14 | 1M | 2M

Ref

1600.1M	white tex
1600.2M	black tex
1600.14	alu satin

built-up

1602/.. - LARA

~230V IP20 0,9700 1 m 05.20.02 CE



built-up wall light - square - fixed - up - with glass  
Wandleuchte für Aufbau - viereckig - fest - up - mit Glas

Lamp type

2x QT14 G9 max. 25W A - E 230V

Dimensions

B180xH80xD80

L180xB80

Materials

aluminium 14 | 1M | 2M

Ref

1602.1M	white tex
1602.2M	black tex
1602.14	alu satin

built-up

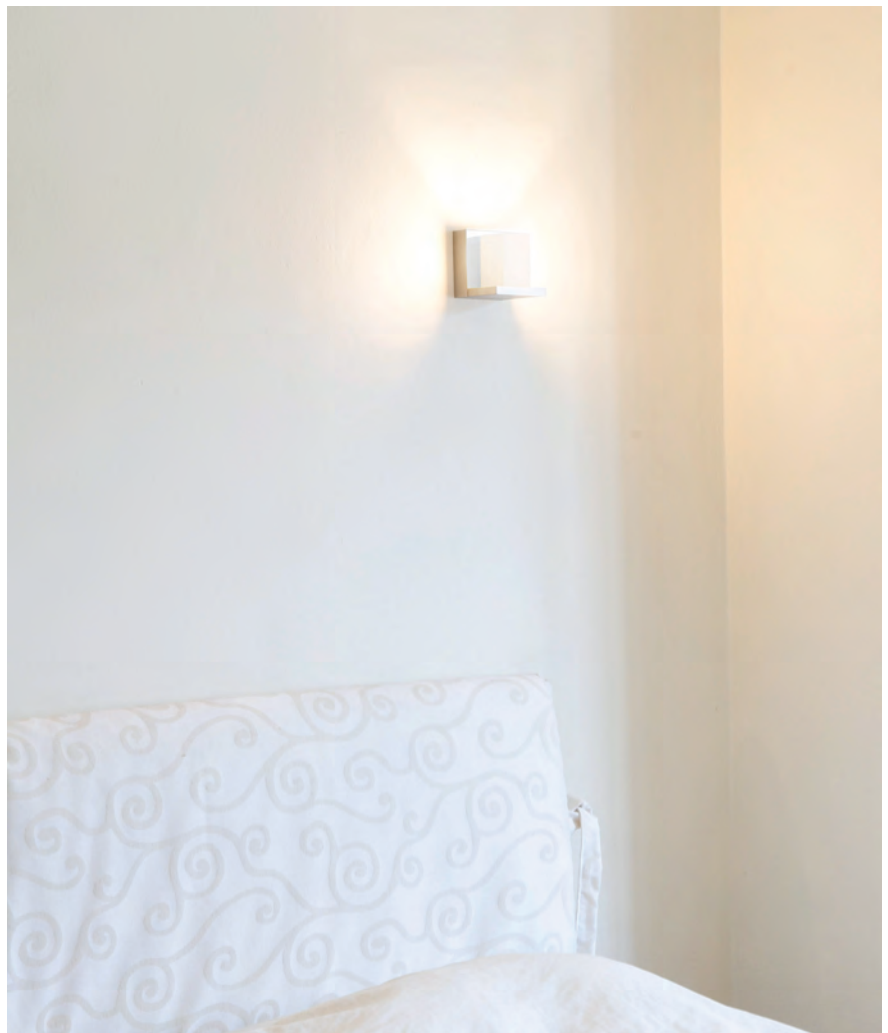

1430LED/.. - CANARIA LED

~230V



IP20



built-up wall light - fixed  
Wandleuchte für Aufbau - fest

Lamp type

1x led 750lm max. 9W A+ 230V

Dimensions

B60xH555xD85

B35xH150

Ref

1430LED.1M	white tex
1430LED.2M	black tex
1430LED.14	alu satin

built-up

1431LED/.. - GRAN CANARIA

~230V



IP20



built-up wall light - fixed  
Wandleuchte für Aufbau - fest

Lamp type

5x led 750lm max. 9W A+ 230V

Dimensions

B60xH1800xD75

B30xH650

Materials

aluminium 1M | 2M

Ref cat (LONG)

1431LED.1M	white tex
1431LED.2M	black tex
1431LED.14	alu satin

built-up

WALL UP

1400LED/.. - LOTUS LED

~230V



built-up wall light - fixed - down/up  
Wandleuchte für Aufbau - fest - down/up

Lamp type

1x 21LED L 1000lm CRI80 max. 8W **A+** 230V

Dimensions

B210xH210xD160

L170xB170

Materials

aluminium 10 | 1M | 2M

Ref

1400LED.1M.NW	white tex
1400LED.2M.NW	black tex
1400LED.10.NW	alu grey

built-up  
phase-cut  
Phasenabschnitt

1401LED/.. - LOTUS UP LED

~230V



built-up wall light - fixed - down/up  
Wandleuchte für Aufbau - fest - down/up

Lamp type

1x 21LED L 1000lm CRI80 max. 8W **A+** 230V

Dimensions

B200xH300xD160

B170xH260

Materials

aluminium 10 | 1M | 2M

Ref

1401LED.1M.NW	white tex
1401LED.2M.NW	black tex
1401LED.10.NW	alu grey

built-up  
phase-cut  
Phasenabschnitt

1402LED/.. - LOTUS UP LED

~230V



built-up wall light - fixed - down/up  
Wandleuchte für Aufbau - fest - down/up

Lamp type

1x 21LED L 1000lm CRI80 max. 8W **A+** 230V

Dimensions

B300xH300xD160

L260xB260

Materials

aluminium 10 | 1M | 2M

Ref

1402LED.1M.NW	white tex
1402LED.2M.NW	black tex
1402LED.10.NW	alu grey

built-up  
phase-cut  
Phasenabschnitt



1261/.. - HAVANA I

~230V

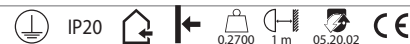

built-up wall light - fixed - up or down  
Wandleuchte für Aufbau - fest - up or down

**Lamp type**

1x QPAR 51 GU10 max. 20W A+ - E 230V

**Dimensions**

B70xH100xD85

L60xB60

**Materials**

aluminium 11 | 14 | 1M | 2M

**Ref**

1261.1M	white tex
1261.2M	black tex
1261.11	alu grey
1261.14	alu satin

built-up

1263/.. - HAVANA II

~230V



built-up wall light - fixed - up or down  
Wandleuchte für Aufbau - fest - up or down

**Lamp type**

2x QPAR 51 GU10 max. 20W A+ - E 230V

**Dimensions**

B130xH100xD85

L60xB60

**Materials**

aluminium 11 | 14 | 1M | 2M

**Ref**

1263.1M	white tex
1263.2M	black tex
1263.11	alu grey
1263.14	alu satin

built-up

1267/.. - HAVANA MIRROR

~230V

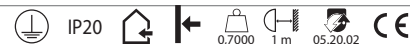

built-up wall light - fixed - up  
Wandleuchte für Aufbau - fest - up

**Lamp type**

2x QPAR 51 GU10 max. 20W A+ - E 230V

**Dimensions**

B130xH225xD85

L60xB60

**Materials**

aluminium 11 | 14 | 1M | 2M

**Ref**

1267.1M	white tex
1267.2M	black tex
1267.11	alu grey
1267.14	alu satin

built-up

3028/.. - MAMBO LED

~230V



IP20

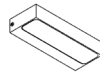

built-up wall light - square - fixed - down  
Wandleuchte für Aufbau - viereckig - fest - down

Lamp type

2x 21LED L 1000lm CRI80 max. 8W **A+** 230V

Dimensions

B200xH35xD80

L200xB35

Ref

3028.1M	NW   WW
3028.2M	NW   WW
3028.10	NW   WW
3028.14	NW   WW
3028.22	NW   WW

built-up  
dimmable phase-cut  
dimmbar Phasenabschnitt

3029/.. - MAMBO LED

~230V



IP20

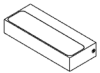

built-up wall light - square - fixed - down/up  
Wandleuchte für Aufbau - viereckig - fest - down/up

Lamp type

4x 21LED L 1000lm CRI80 max. 8W **A+** 230V

Dimensions

B200xH35xD80

L200xB35







Ref

3029.1M	WW
3029.2M	WW
3029.14	WW
3029.22	WW

built-up  
dimmable phase-cut  
dimmbar Phasenabschnitt



**3030.LED/.. - MAMBO LED**

~230V  IP20      

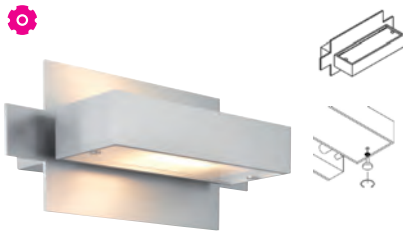

built-up wall light - square - fixed - down/up  
Wandleuchte für Aufbau - viereckig - fest - down/up

**Lamp type**  
2x Led 900lm CRI80 max. 10W  230V

**Dimensions**  
B325xH135xD138  
L235xB45

**Materials**  
aluminium 11 | 14 | 1M | 2M  
brass 16

**Ref**

3030.LED.1M.NW	white tex
3030.LED.2M.NW	black tex
3030.LED.11.NW	alu grey
3030.LED.14.NW	alu satin
3030.LED.16.NW	satin gold

**built-up**  
Dimmable phase-cut  
Dimmbar Phasenabschnitt  
Do not screw on too tightly  
Nicht zu fest verschrauben

**3032.LED/.. - MAMBO LED**

~230V  IP20      



built-up wall light - square - fixed - down/up  
Wandleuchte für Aufbau - viereckig - fest - down/up

**Lamp type**  
2x Led 900lm CRI80 max. 10W  230V

**Dimensions**  
B325xH90xD138  
L235xB45







**Materials**  
aluminium 11 | 14 | 1M | 2M  
brass 16

**Ref**

3032.LED.1M.NW	white tex
3032.LED.2M.NW	black tex
3032.LED.11.NW	alu grey
3032.LED.14.NW	alu satin
3032.LED.16.NW	satin gold

**built-up**  
Dimmable phase-cut  
Dimmbar Phasenabschnitt  
Do not screw on too tightly  
Nicht zu fest verschrauben

**3034.LED/.. - MAMBO LED**

~230V  IP20      



built-up wall light - square - fixed - down/up  
Wandleuchte für Aufbau - viereckig - fest - down/up

**Lamp type**  
2x Led 900lm CRI80 max. 10W  230V

**Dimensions**  
B285xH90xD135  
L235xB45







**Materials**  
aluminium 11 | 14 | 1M | 2M  
brass 16

**Ref**

3034.LED.1M.NW	white tex
3034.LED.2M.NW	black tex
3034.LED.11.NW	alu grey
3034.LED.14.NW	alu satin
3034.LED.16.NW	satin gold

**built-up**  
Dimmable phase-cut  
Dimmbar Phasenabschnitt  
Do not screw on too tightly  
Nicht zu fest verschrauben

**3050.LED/.. - MAMBO LED**

~230V  IP20      



built-up wall light - down/up  
Wandleuchte für Aufbau - down/up

**Lamp type**  
2x Led 900lm CRI80 max. 10W  230V

**Dimensions**  
B235xH45xD135  
L235xB45

**Materials**  
aluminium 11 | 14 | 1M | 2M  
brass 16

**Ref**

3050.LED.1M.NW	white tex
3050.LED.2M.NW	black tex
3050.LED.11.NW	alu grey
3050.LED.14.NW	alu satin
3050.LED.16.NW	satin gold

**built-up**  
Dimmable phase-cut  
Dimmbar Phasenabschnitt  
Do not screw on too tightly  
Nicht zu fest verschrauben







3045/.. - MICRO

~230V



IP20

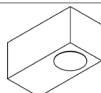

built-up wall light - square - fixed - up or down  
Wandleuchte für Aufbau - viereckig - fest - up or down

Lamp type

1x Led 900lm CRI80 max. 8W 230V

Dimensions

B60xH60xD121

L60xB60

Ref

3045.1M	NW   WW
3045.2M	NW   WW
3045.14	NW   WW
3045.45	NW   WW

built-up  
Dimmable phase-cut  
Dimmbar Phasenabschnitt

1419W/.. - CANVAS

~230V



IP20



built-up ceiling or wall light - square - fixed - with opal white glass  
Decken- oder Wandleuchte für Aufbau - viereckig - fest - mit opalweißem Glas

Lamp type

1x LED 1000lm CRI80 max. 12W 230V

Dimensions

B200xH200xD63 180° reflector

L125xB115

Materials

aluminium 14 | 1M | 2M

Ref

1419W.1M.WW	white tex
1419W.2M.WW	black tex
1419W.14.WW	alu satin

built-up

WALL UP



5805.300/.. - VEGA

~230V    IP44    0,3600  0,5 m  05.20.50 



built-up wall light - directional - with LED driver  
Wandleuchte für Aufbau - schwenkbar - mit Driver LED

<b>Lamptype</b>	
--- 1x Led 329lm CRI80 max. 5W 	24V-DC
<b>Dimensions</b>	
← B300xH25xD86	
Base - B300xH25xD25	
<b>Materials</b>	
aluminium	14   1M   2M
brass	13   23
INOX	48

<b>Ref</b>	
5805.300.1M.NW	white tex
5805.300.2M.NW	black tex
5805.300.13.NW	bronze
5805.300.14.NW	alu satin
5805.300.23.NW	dark bronze
5805.300.48.NW	inox high gloss

built-up

5805.600/.. - VEGA

~230V    IP44    3,3330  0,5 m  05.20.50 



built-up wall light - directional - with LED driver  
Wandleuchte für Aufbau - schwenkbar - mit Driver LED

<b>Lamptype</b>	
--- 1x Led 659lm CRI80 max. 10W 	24V-DC
<b>Dimensions</b>	
← B610xH25xD86	
Base - B610xH25xD25	
<b>Materials</b>	
aluminium	14   1M   2M
brass	13   23
INOX	48

<b>Ref</b>	
5805.600.1M.NW	white tex
5805.600.2M.NW	black tex
5805.600.13.NW	bronze
5805.600.14.NW	alu satin
5805.600.23.NW	dark bronze
5805.600.48.NW	inox high gloss

built-up

5805.900/.. - VEGA

~230V    IP44    1,4400  0,5 m  05.20.50 



built-up wall light - directional - with LED driver  
Wandleuchte für Aufbau - schwenkbar - mit Driver LED

<b>Lamptype</b>	
--- 1x Led 983lm CRI80 max. 15W 	24V-DC
<b>Dimensions</b>	
← B910xH25xD86	
Base - B910xH25xD25	
<b>Materials</b>	
aluminium	14   1M   2M
brass	23
INOX	48

<b>Ref</b>	
5805.900.1M.NW	white tex
5805.900.2M.NW	black tex
5805.900.14.NW	alu satin
5805.900.23.NW	dark bronze
5805.900.48.NW	inox high gloss

built-up

5805.1200/.. - VEGA

~230V    IP44    2,2220  0,5 m  05.20.50 



built-up wall light - directional - with LED driver  
Wandleuchte für Aufbau - schwenkbar - mit Driver LED

<b>Lamptype</b>	
--- 1x Led 1307lm CRI80 max. 20W 	24V-DC
<b>Dimensions</b>	
← B1210xH25xD86	
Base - B1210xH25xD25	
<b>Materials</b>	
aluminium	14   1M   2M
brass	23
INOX	48

<b>Ref</b>	
5805.1200.1M.NW	white tex
5805.1200.2M.NW	black tex
5805.1200.14.NW	alu satin
5805.1200.23.NW	dark bronze
5805.1200.48.NW	inox high gloss

built-up

641.HL105/.. - MONET

~230V



built-up wall light - stainless steel housing + polycarbonate cover  
Wandleuchte für Aufbau - Gehäuse in Edelstahl + Deckel in Polykarbonat

Lamp type

1x TCR-TSE GX53 max. 5W **A+** - **E** 230V

Dimensions

B104xH55xD120

Materials

INOX 5 | 1M | 2M

Ref

641.HL105.1M	white tex
641.HL105.2M	black tex
641.HL105.5	inox 316

built-up

641.HL335.LED/.. - MONET LED

~230V

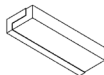

built-up wall light - stainless steel housing + polycarbonate cover  
Wandleuchte für Aufbau - Gehäuse in Edelstahl + Deckel in Polykarbonat

Lamp type

1x led 1500lm max. 16W **A+** 230V

Dimensions

B335xH55xD94

Materials

INOX 5 | 1M | 2M

Ref

641.HL335.LED.1M.NW	white tex
641.HL335.LED.1M.WW	white tex
641.HL335.LED.2M.NW	black tex
641.HL335.LED.2M.WW	black tex
641.HL335.LED.5.NW	inox 316
641.HL335.LED.5.WW	inox 316

built-up

Dimmable phase-cut  
Phasenabschnitt

641.HL600/.. - MONET

~230V

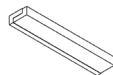

built-up wall light - stainless steel housing + polycarbonate cover - with electronic gear  
Wandleuchte für Aufbau - Gehäuse in Edelstahl + Deckel in Polykarbonat - mit elektronischem Vorschaltgerät

Lamp type

1x T16FQ T5 G5 max. 24W **A+** 230V

Dimensions

B604xH55xD94

Materials

INOX 5 | 1M | 2M

Ref

641.HL600.1M	white tex
641.HL600.2M	black tex
641.HL600.5	inox 316

built-up

641.HL600.LED/.. - MONET LED

~230V

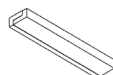

built-up wall light - stainless steel housing + polycarbonate cover  
Wandleuchte für Aufbau - Gehäuse in Edelstahl + Deckel in Polykarbonat

Lamp type

1x led 1500lm max. 16W **A+** 230V

Dimensions

B604xH55xD94

Materials

INOX 5 | 1M | 2M

Ref

641.HL600.LED.1M.NW	white tex
641.HL600.LED.1M.WW	white tex
641.HL600.LED.2M.NW	black tex
641.HL600.LED.2M.WW	black tex
641.HL600.LED.5.NW	inox 316
641.HL600.LED.5.WW	inox 316

built-up

Dimmable phase-cut  
Phasenabschnitt

**641.SL335.LED/.. - MONET STRIP LED**

~230V



IP44



built-up ceiling or wall light - stainless steel housing + polycarbonate cover  
Decken- oder Wandleuchte für Aufbau - Gehäuse in Edelstahl + Deckel in Polykarbonat

**Lamptype**

1x led 1500lm max. 16W **A+** 230V

**Dimensions**

L335xB55xH95

**Materials**

INOX 5 | 1M | 2M

**Ref**

- 641.SL335.LED.1M.NW white tex
- 641.SL335.LED.1M.WW white tex
- 641.SL335.LED.2M.NW black tex
- 641.SL335.LED.2M.WW black tex
- 641.SL335.LED.5.NW inox 316
- 641.SL335.LED.5.WW inox 316

built-up  
Dimmable phase-cut  
Phasenabschnitt

**641.SL600.LED/.. - MONET STRIP LED**

~230V



IP44

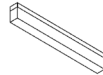

built-up ceiling or wall light - stainless steel housing + polycarbonate cover  
Decken- oder Wandleuchte für Aufbau - Gehäuse in Edelstahl + Deckel in Polykarbonat

**Lamptype**

1x led 1500lm max. 16W **A+** 230V

**Dimensions**

L605xB55xH95

**Materials**

INOX 5 | 1M | 2M

**Ref**

- 641.SL600.LED.1M.NW white tex
- 641.SL600.LED.1M.WW white tex
- 641.SL600.LED.2M.NW black tex
- 641.SL600.LED.2M.WW black tex
- 641.SL600.LED.5.NW inox 316
- 641.SL600.LED.5.WW inox 316

built-up  
Dimmable phase-cut  
Phasenabschnitt



641.VL105/.. - MONET

~230V



built-up wall light - stainless steel housing + polycarbonate cover  
Wandleuchte für Aufbau - Gehäuse in Edelstahl + Deckel in Polykarbonat

**Lamp type**

1x TCR-TSE GX53 max. 5W **A+** - **E** 230V

**Dimensions**

B104xH120xD55

**Materials**

INOX 5 | 1M | 2M

**Ref**

641.VL105.1M	white tex
641.VL105.2M	black tex
641.VL105.5	inox 316

built-up

641.VL335.LED/.. - MONET LED

~230V



built-up wall light - stainless steel housing + polycarbonate cover  
Wandleuchte für Aufbau - Gehäuse in Edelstahl + Deckel in Polykarbonat

**Lamp type**

1x led 1500lm max. 16W **A+** 230V

**Dimensions**

B335xH94xD55

**Materials**

INOX 5 | 1M | 2M

**Ref**

641.VL335.LED.1M.NW	white tex
641.VL335.LED.1M.WW	white tex
641.VL335.LED.2M.NW	black tex
641.VL335.LED.2M.WW	black tex
641.VL335.LED.5.NW	inox 316
641.VL335.LED.5.WW	inox 316

built-up

Dimmable phase-cut  
Phasenabschnitt

641.VL600/.. - MONET

~230V



built-up wall light - stainless steel housing + polycarbonate cover - with electronic gear  
Wandleuchte für Aufbau - Gehäuse in Edelstahl + Deckel in Polykarbonat - mit elektronischem Vorschaltgerät

**Lamp type**

1x T16FQ T5 G5 max. 24W **A+** 230V

**Dimensions**

B604xH94xD55

**Materials**

INOX 5 | 1M | 2M

**Ref**

641.VL600.1M	white tex
641.VL600.2M	black tex
641.VL600.5	inox 316

built-up

641.VL600.LED/.. - MONET LED

~230V



built-up wall light - stainless steel housing + polycarbonate cover  
Wandleuchte für Aufbau - Gehäuse in Edelstahl + Deckel in Polykarbonat

**Lamp type**

1x led 1500lm max. 16W **A+** 230V

**Dimensions**

B604xH94xD55

**Materials**

INOX 5 | 1M | 2M

**Ref**

641.VL600.LED.1M.NW	white tex
641.VL600.LED.1M.WW	white tex
641.VL600.LED.2M.NW	black tex
641.VL600.LED.2M.WW	black tex
641.VL600.LED.5.NW	inox 316
641.VL600.LED.5.WW	inox 316

built-up

Dimmable phase-cut  
Phasenabschnitt

1250/.. - OUTSIDER

~12V 0,4600 0,5 m 05.20.02



built-up wall light - square - fixed - down - without transformer  
Wandleuchte für Aufbau - viereckig - fest - down - ohne Trafo

**Ref**  
1250.31MA white texture ano  
1250.32A black texture ano

**Lamp type**  
 1x QT12 GY6,35 max. 50W - **12V**

**Dimensions**  
 B100xH100xD38

**Materials**  
aluminium **32A | 31MA**

built-up

1250C/.. - OUTSIDER

~12V 0,4300 0,5 m 05.20.02



built-up wall light - square - fixed - down - without transformer  
Wandleuchte für Aufbau - viereckig - fest - down - ohne Trafo

**Ref**  
1250C.31MA white texture ano  
1250C.32A black texture ano

**Lamp type**  
 1x QT12 GY6,35 max. 50W - **12V**

**Dimensions**  
 B100xH100xD38

**Materials**  
aluminium **32A | 31MA**

built-up

3040LED/.. - RAYA LED

~230V 1 m 05.20.50



built-up wall light - square - fixed - up  
Wandleuchte für Aufbau - viereckig - fest - up

**Ref**  
3040LED.1M NW  
3040LED.2M NW  
3040LED.40 NW

**Lamp type**  
 1x 21LED L 1000lm CRI80 max. 8W **230V**

**Dimensions**  
 B120xH180xD60

built-up  
dimmable phase-cut  
dimmbar Phasenabschnitt

3041/.. - RAYA MINI

~230V 0,6150 1 m 05.20.02



built-up wall light - square - fixed - up  
Wandleuchte für Aufbau - viereckig - fest - up

**Ref**  
3041.1M white tex  
3041.2M black tex  
3041.40 anodised alu

**Lamp type**  
 1x QPAR 51 GU10 max. 20W - **230V**

**Dimensions**  
 B100xH100xD80

**Materials**  
aluminium **1M | 2M | 40**

built-up

1269/.. - SURF

~230V



built-up wall light - directional - with transformer  
Wandleuchte für Aufbau - schwenkbar - mit Trafo

Lamp type

1x QR-CB 51 GU5,3/GX5,3 max. 50W **A+** - **E** 12V

Dimensions

B100xH120xD105

B60xH100

Materials

aluminium 14 | 2M

Ref

1269.2M black tex  
1269.14 alu satin

built-up  
60VA - use coolfit lamp  
Coolfit-Lampe verwenden

1270/.. - SURF

~12V



built-up wall light - directional - without transformer  
Wandleuchte für Aufbau - schwenkbar - ohne Trafo

Lamp type

1x QR-CB 51 GU5,3/GX5,3 max. 50W **A+** - **E** 12V

Dimensions

B100xH120xD105

B60xH60

Materials

aluminium 14 | 1M | 2M

Ref

1270.1M white tex  
1270.2M black tex  
1270.14 alu satin

built-up  
use coolfit lamp  
Coolfit-Lampe verwenden

1271/.. - SURF

~230V



built-up wall light - directional  
Wandleuchte für Aufbau - schwenkbar

Lamp type

1x QPAR 51 GU10 max. 20W **A+** - **E** 230V

Dimensions

B100xH120xD105

L60xB60

Materials

aluminium 14 | 1M | 2M | 40

Ref

1271.1M white tex  
1271.2M black tex  
1271.14 alu satin  
1271.40 anodised alu

built-up

1271.ES63/.. - SURF

~230V



built-up wall light - directional  
Wandleuchte für Aufbau - schwenkbar

Lamp type

1x QPAR64 GU10 max. 75W **A+** - **D** 230V

Dimensions

B100xH120xD105

L60xB60

Materials

aluminium 1M | 2M | 40

Ref

1271.ES63.1M white tex  
1271.ES63.2M black tex  
1271.ES63.40 anodised alu

built-up

3076/.. - TOLEDO WALL

~230V



built-up wall light - fixed - down - with mounting bracket at the back  
 Wandleuchte für Aufbau - fest - down - mit Befestigungsbügel hinten

Ref

3076.1M  
 3076.2M  
 3076.14

white tex  
 black tex  
 alu satin

Lamptype

1x TCR-TSE GX53 max. 5W A+ - E 230V

Dimensions

B90xH30xD120

L90xB30

Materials

aluminium 14 | 1M | 2M

built-up  
 CFL GX53 4W on request  
 auf Anfrage





1280LED/.. - ZEN LED

~230V



built-up wall light - fixed - up  
Wandleuchte für Aufbau - fest - up

Lamp type

1x Led 230lm CRI80 max. 4W **A+** 230V

Dimensions

B60xH285xD60

Materials

aluminium 1M | 2M | 40

Ref

1280LED.1M.NW white tex  
1280LED.2M.NW black tex  
1280LED.40.NW anodised alu

built-up

1281LED/.. - ZEN LED

~230V



built-up wall light - fixed - up  
Wandleuchte für Aufbau - fest - up

Lamp type

1x 42LED L 1588lm CRI80 max. 16W **A+** 230V

Dimensions

B160xH285xD60

Materials

aluminium 1M | 2M | 40

Ref

1281LED.1M.NW white tex  
1281LED.2M.NW black tex  
1281LED.40.NW anodised alu

built-up  
dimmable phase-cut  
dimmbar Phasenabschnitt

1282LED/.. - ZEN LED

~230V



built-up wall light - fixed - up  
Wandleuchte für Aufbau - fest - up

Lamp type

1x 42LED L 1588lm CRI80 max. 16W **A+** 230V

Dimensions

B210xH285xD60

Materials

aluminium 1M | 2M | 40

Ref

1282LED.1M.NW white tex  
1282LED.2M.NW black tex  
1282LED.40.NW anodised alu

built-up  
dimmable phase-cut  
dimmbar Phasenabschnitt

1500LED/.. - WAVE LED

~230V



built-up wall light  
Wandleuchte für Aufbau

Lamp type

8x led 750lm max. 9W **A+** 230V

Dimensions

B600xH600xD112

Ref

1500LED.NW led natural white

built-up  
dimmable phase-cut  
dimmbar Phasenabschnitt



WALL UP

1770.400/.. - INDY

~230V

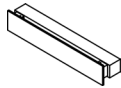

built-up wall light - fixed - down/up - with transformer  
Wandleuchte für Aufbau - fest - down/up - mit Trafo

Lamp type

2x Led 576lm CRI80 max. 8W A+ 24V-DC

Dimensions

B400xH70xD75

B400xH45

Ref

1770.400.1M CW | NW | WW

1770.400.2M CW | NW | WW

1770.400.14 CW | NW | WW

built-up  
chrome on request  
Chrom auf Anfrage

1770.600/.. - INDY

~230V

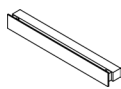

built-up wall light - fixed - down/up - with transformer  
Wandleuchte für Aufbau - fest - down/up - mit Trafo

Lamp type

2x Led 864lm CRI80 max. 12W A+ 24V-DC

Dimensions

B600xH70xD75

B600xH45

Ref

1770.600.1M CW | NW | WW

1770.600.2M CW | NW | WW

1770.600.14 CW | NW | WW

built-up  
chrome on request  
Chrom auf Anfrage

1771.400/.. - INDY

~230V

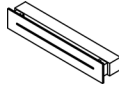

built-up wall light - fixed - down/up - cover plate with opening - with transformer  
Wandleuchte für Aufbau - fest - down/up - Abdeckplatte mit Schlitz - mit Trafo

Ref

1771.400.1M	CW   NW   WW
1771.400.2M	CW   NW   WW
1771.400.14	CW   NW   WW

Lamp type

2x Led 576lm CRI80 max. 8W A+ 24V-DC

Dimensions

B400xH70xD75

B400xH45

built-up  
chrome on request  
Chrom auf Anfrage

1771.600/.. - INDY

~230V



built-up wall light - fixed - down/up - cover plate with opening - with transformer  
Wandleuchte für Aufbau - fest - down/up - Abdeckplatte mit Schlitz - mit Trafo

Ref

1771.600.1M	CW   NW   WW
1771.600.2M	CW   NW   WW
1771.600.14	CW   NW   WW

Lamp type

2x Led 864lm CRI80 max. 12W A+ 24V-DC

Dimensions

B600xH70xD75

B600xH45

built-up  
chrome on request  
Chrom auf Anfrage

1772.600/.. - INDY

~230V

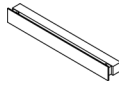

built-up wall light - fixed - down/up - with electronic gear  
Wandleuchte für Aufbau - fest - down/up - mit elektronischem Vorschaltgerät

Ref

1772.600.1M	white tex
1772.600.2M	black tex
1772.600.14	alu satin

Lamp type

1x T16FQ T5 G5 max. 24W A+ 230V

Dimensions

B600xH70xD75

B600xH45

Materials

aluminium 14 | 1M | 2M

built-up  
chrome on demand  
Chrom auf Anfrage

1773.600/.. - INDY

~230V



built-up wall light - fixed - down/up - cover plate with opening - with electronic gear  
Wandleuchte für Aufbau - fest - down/up - Abdeckplatte mit Schlitz - mit elektronischem Vorschaltgerät

Ref

1773.600.1M	white tex
1773.600.2M	black tex
1773.600.14	alu satin

Lamp type

1x T16FQ T5 G5 max. 24W A+ 230V

Dimensions

B600xH70xD75

B600xH45

Materials

aluminium 14 | 1M | 2M

built-up  
chrome on demand  
Chrom auf Anfrage

1772.900/.. - INDY

~230V



built-up wall light - fixed - down/up - with electronic gear  
Wandleuchte für Aufbau - fest - down/up - mit elektronischem Vorschaltgerät

Ref

1772.900.1M	white tex
1772.900.2M	black tex
1772.900.14	alu satin

Lamptype

1x T16FH T5 G5 max. 21W A - D 230V

Dimensions

B900xH70xD75  
B900xH45

Materials

aluminium 14 | 1M | 2M

built-up

1773.900/.. - INDY

~230V



built-up wall light - fixed - down/up - cover plate with opening - with electronic gear  
Wandleuchte für Aufbau - fest - down/up - Abdeckplatte mit Schlitz - mit elektronischem Vorschaltgerät

Ref

1773.900.1M	white tex
1773.900.2M	black tex
1773.900.14	alu satin

Lamptype

1x T16FH T5 G5 max. 21W A - D 230V

Dimensions

B900xH70xD75  
B900xH45

Materials

aluminium 14 | 1M | 2M

built-up

1772.1200/.. - INDY

~230V



built-up wall light - fixed - down/up - with electronic gear  
Wandleuchte für Aufbau - fest - down/up - mit elektronischem Vorschaltgerät

Ref

1772.1200.1M	white tex
1772.1200.14	alu satin

Lamptype

1x T16FH T5 G5 max. 28W A - D 230V

Dimensions

B1200xH70xD75  
B1200xH45

Materials

aluminium 14 | 1M

built-up

1773.1200/.. - INDY

~230V



built-up wall light - fixed - down/up - cover plate with opening - with electronic gear  
Wandleuchte für Aufbau - fest - down/up - Abdeckplatte mit Schlitz - mit elektronischem Vorschaltgerät

Ref

1773.1200.1M	white tex
1773.1200.2M	black tex
1773.1200.14	alu satin

Lamptype

1x T16FH T5 G5 max. 28W A - D 230V

Dimensions

B1200xH70xD75  
B1200xH45

Materials

aluminium 14 | 1M | 2M

built-up



1774.400/.. - INDY

~230V



IP44

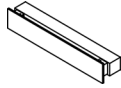

built-up wall light - fixed - down/up - with transformer  
Wandleuchte für Aufbau - fest - down/up - mit Trafo

Lamp type

2x Led 576lm CRI80 max. 8W A+ 24V-DC

Dimensions

B400xH70xD75

B400xH45

Ref

1774.400.1M CW | NW | WW

1774.400.2M CW | NW | WW

1774.400.14 CW | NW | WW

built-up

with switch and dimming system

mit Schalter und Abblendsystem

chrome on request

Chrom auf Anfrage

1775.400/.. - INDY

~230V



IP44

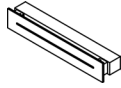

built-up wall light - fixed - down/up - cover plate with  
opening - with transformer  
Wandleuchte für Aufbau - fest - down/up - Abdeckplatte mit  
Schlitz - mit Trafo

Lamp type

2x Led 576lm CRI80 max. 8W A+ 24V-DC

Dimensions

B400xH70xD75

B400xH45

Ref

1775.400.1M CW | NW | WW

1775.400.2M CW | NW | WW

1775.400.14 CW | NW | WW

built-up

with switch and dimming system

mit Schalter und Abblendsystem

chrome on request

Chrom auf Anfrage

1799/.. - BRIDGE WALL

~230V   IP20    2,7300  05.20.02 

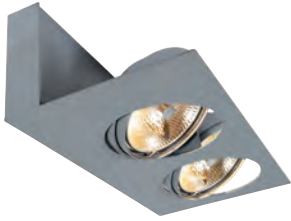

built-up wall light - directional - down - with transformer  
Wandleuchte für Aufbau - schwenkbar - down - mit Trafo

**Lamp type**

 2x QR-LP111 G53 max. 20W  12V

**Dimensions**

 B350xH123xD190

 B180xH120

**Materials**

aluminium 1M | 2M | 11M

**Ref**

1799.1M	white tex
1799.2M	black tex
1799.2M.7	black tex
1799.11M	grey tex

built-up  
50VA

2126LED/.. - METRO LED

~230V



IP20



lighting system - directional - down - 3 openings  
Lichtsystem - schwenkbar - down - 3 Löcher

Lamptype

1x led 750lm max. 9W 230V

Dimensions

Ø100xH850

Materials

aluminium 1M | 2M | 40

Ref

2126LED.1M.NW white tex  
2126LED.2M.NW black tex  
2126LED.40.NW anodised alu

built-up

Dimmable phase-cut  
Phasenabschnitt

2604/.. - MIKADO WALL

~230V



IP20



built-up wall light - fixed - lamp not covered - with electronic gear  
Wandleuchte für Aufbau - fest - Leuchtmittel nicht abgedeckt  
- mit elektronischem Vorschaltgerät

Lamptype

1x T16FQ T5 G5 max. 24W 230V

Dimensions

Ø35xL1004

Materials

aluminium 14

Ref

2604.14 alu satin

built-up

3120/.. - OMEGA

~230V

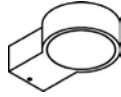

built-up wall light - fixed - up or down  
Wandleuchte für Aufbau - fest - up or down

Ref

3120.1M	NW   WW
3120.2M	NW   WW
3120.14	NW   WW

Lamp type

1x Led 230V max. 3,6W **A+** 230V

Dimensions

Ø80xD120



**built-up**

24V-DC on request

24V-DC auf Anfrage

14 and 1M not suitable for moist surroundings

14 und 1M nicht geeignet für feuchte Räume

3121/.. - OMEGA

~230V



built-up wall light - fixed  
Wandleuchte für Aufbau - fest

Ref

3121.2M	WW
3121.14	NW   WW

Lamp type

1x Led 230V max. 3,6W **A+** 230V

Dimensions

Ø80xH120xD60



**built-up**

24V-DC on request

24V-DC auf Anfrage

color 14 not suitable for moist surroundings

Farbe 14 nicht geeignet für feuchte Räume





3130/.. - TAO

~230V

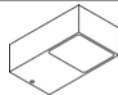
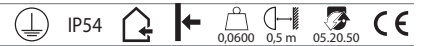

built-up wall light - square - fixed - up or down  
Wandleuchte für Aufbau - viereckig - fest - up oder down

Lamp type

1x Led 230V max. 3W **A+** 230V

Dimensions

B50xH30xD87

Ref

3130.1M	NW   WW
3130.2M	NW   WW
3130.14	NW   WW
3130.32A	NW   WW

**built-up**  
LED included  
LED einbegriffen  
colour 14 not suitable for moist surroundings  
Farbe 14 nicht geeignet für feuchte Räume

3131/.. - TAO

=24V-DC

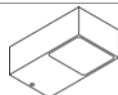

built-up wall light - square - fixed - up or down - without transformer  
Wandleuchte für Aufbau - viereckig - fest - up oder down - ohne Trafo

Lamp type

1x Led 24V-DC max. 3W **A+** 24V-DC

Dimensions

B50xH30xD87

Ref

3131.1M	NW   WW
3131.2M	NW   WW
3131.14	NW   WW
3131.32A	NW   WW

**built-up**  
LED included  
LED einbegriffen  
colour 14 not suitable for moist surroundings  
Farbe 14 nicht geeignet für feuchte Räume

4026.W1/.. - GUILIA

~230V IP20 0,8340 0,5 m 05.20.02 CE



built-up wall light - up - with glass  
Wandleuchte für Aufbau - up - mit Glas

Lamp type

1x QT14 G9 max. 20W A - E 230V

Dimensions

B80xH225xD130

L55xB55

Glass - Ø60xH120

Options

R1029 - GUILIA A spare glass

Materials

aluminium 14 | 1M | 2M  
brass 13 | 16

Ref

4026.W1.1M white tex  
4026.W1.2M black tex  
4026.W1.13 bronze  
4026.W1.14 alu satin  
4026.W1.16 satin gold

built-up  
clear glass with matt edge  
Klarglas mit mattiertem Rand

4026.W2/.. - GUILIA

~230V IP20 1,7480 0,5 m 05.20.02 CE



built-up wall light - up - with glass  
Wandleuchte für Aufbau - up - mit Glas

Lamp type

2x QT14 G9 max. 20W A - E 230V

Dimensions

B190xH225xD130

L165xB55

Glass - Ø60xH120

Options

R1029 - GUILIA A spare glass

Materials

aluminium 14 | 1M | 2M  
brass 13 | 16

Ref

4026.W2.1M white tex  
4026.W2.2M black tex  
4026.W2.13 bronze  
4026.W2.14 alu satin  
4026.W2.16 satin gold

built-up  
clear glass with matt edge  
Klarglas mit mattiertem Rand

4027.W1/.. - GUILIA

~230V IP20 1,0550 0,5 m 05.20.02 CE



built-up wall light - up - with glass  
Wandleuchte für Aufbau - up - mit Glas

Lamp type

1x QT14 G9 max. 20W A - E 230V

Dimensions

B80xH225xD130

L55xB55

Glass - Ø60xH120

Options

R1028 - GUILIA B spare glass

Materials

aluminium 14 | 1M | 2M  
brass 13 | 16

Ref

4027.W1.1M white tex  
4027.W1.2M black tex  
4027.W1.13 bronze  
4027.W1.14 alu satin  
4027.W1.16 satin gold

built-up  
with matt glass  
mit mattiertem Glas

4027.W2/.. - GUILIA

~230V IP20 1,7500 0,5 m 05.20.02 CE



built-up wall light - up - with glass  
Wandleuchte für Aufbau - up - mit Glas

Lamp type

2x QT14 G9 max. 20W A - E 230V

Dimensions

B190xH225xD130

L165xB55

Glass - Ø60xH120

Options

R1028 - GUILIA B spare glass

Materials

aluminium 14 | 1M | 2M  
brass 13 | 16

Ref

4027.W2.1M white tex  
4027.W2.2M black tex  
4027.W2.13 bronze  
4027.W2.14 alu satin  
4027.W2.16 satin gold

built-up  
with matt glass  
mit mattiertem Glas

4025.W1/.. - MAX

~230V IP20 1,0500 0,5 m 05.20.02 CE



built-up wall light - up - with mat glass  
Wandleuchte für Aufbau - up - mit mattem Glas

**Lamp type**  
1x QT14 G9 max. 20W **A** - **E** **230V**

**Dimensions**  
B80xH255xD130  
L55xB55

**Options**  
461507 - MAX spare glass

**Materials**  
aluminium 14 | 1M | 2M  
brass 16

Ref	
4025.W1.1M	white tex
4025.W1.2M	black tex
4025.W1.14	alu satin
4025.W1.16	satin gold

built-up

4025.W2/.. - MAX

~230V IP20 2,1700 0,5 m 05.20.02 CE



built-up wall light - up - with mat glass  
Wandleuchte für Aufbau - up - mit mattem Glas

**Lamp type**  
2x QT14 G9 max. 20W **A** - **E** **230V**

**Dimensions**  
B190xH255xD130  
L165xB55

**Options**  
461507 - MAX spare glass

**Materials**  
aluminium 14 | 1M | 2M  
brass 16

Ref	
4025.W2.1M	white tex
4025.W2.2M	black tex
4025.W2.14	alu satin
4025.W2.16	satin gold

built-up

4018.ES50/.. - NOA glass + alu

~230V IP20 1,5600 0,5 m 05.20.02 CE



built-up wall light - up - with mat glass  
Wandleuchte für Aufbau - up - mit mattem Glas

**Lamp type**  
1x QPAR 51 GU10 max. 7W **A** - **E** **230V**

**Dimensions**  
Ø60xH350xD140  
Ø60

**Materials**  
aluminium 14 | 1M | 2M  
brass 16

Ref	
4018.ES50.1M	white tex
4018.ES50.2M	black tex
4018.ES50.14	alu satin
4018.ES50.16	satin gold

built-up  
60VA - use coolfit lamp  
Coolfit-Lampe verwenden

4020.ES50/.. - NOA PC

~230V IP20 1,1770 0,5 m 05.20.02 CE



built-up wall light - up - polycarbonate  
Wandleuchte für Aufbau - up - Polykarbonat

**Lamp type**  
1x QPAR 51 GU10 max. 7W **A** - **E** **230V**

**Dimensions**  
Ø60xH350xD140  
Ø60  
Head -

**Materials**  
aluminium 14 | 1M | 2M  
brass 16

Ref	
4020.ES50.1M	white tex
4020.ES50.2M	black tex
4020.ES50.14	alu satin
4020.ES50.16	satin gold

built-up









5037/.. - MAESTRO

~230V  IP20    0,2300  0,5 m  



built-up ceiling or wall light - directional - with E27 lampholder  
Decken- oder Wandleuchte für Aufbau - schwenkbar - mit E27 Fassung

**Lamp type**

 1x A60 E27 max. 10,5W  230V  
or  1x ST64 E27 max. 7,7w  230V

**Dimensions**

 Ø60xH132  
Base - Ø60xH25  
Housing - Ø46xH62  
Bar - H45

**Materials**

aluminium 14 | 1M | 2M | 46  
brass 13 | 16

**Ref**

5037.1M	white tex
5037.2M	black tex
5037.13	bronze
5037.14	alu satin
5037.16	satin gold
5037.46	grey-brown

built-up

5053/.. - MAESTRO

~230V  IP20    0,3000  0,5 m  

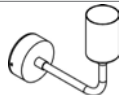

built-up wall light - fixed - with E27 lampholder  
Wandleuchte für Aufbau - fest - mit E27 Fassung

**Lamp type**

 1x A60 E27 max. 40W  230V  
or  1x ST64 E27 max. 40W  230V

**Dimensions**

 Ø60xH160xD160  
Base - Ø60xH25

**Materials**

aluminium 1M | 2M | 46

**Ref**

5053.1M	white tex
5053.2M	black tex
5053.46	grey-brown

built-up

5054/.. - MAESTRO

~230V  IP20    0,3300  0,5 m  

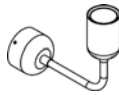

built-up wall light - fixed - with E27 lampholder  
Wandleuchte für Aufbau - fest - mit E27 Fassung

**Lamp type**

 1x A60 E27 max. 10,5W  230V  
or  1x ST64 E27 max. 40W  230V

**Dimensions**

 Ø60xH160xD160  
Base - Ø60xH45

**Materials**

aluminium 1M | 2M | 46

**Ref**

5054.1M	white tex
5054.2M	black tex
5054.46	grey-brown

built-up

5055/.. - MAESTRO

~230V

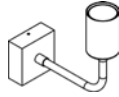
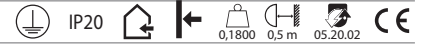

built-up wall light - fixed - with E27 lampholder  
Wandleuchte für Aufbau - fest - mit E27 Fassung

Lamp type

1x A60 E27 max. 10,5W A - E 230V

or 1x ST64 E27 max. 40W A - E 230V

Dimensions

B60xH160xD160

Base - L60xB60xH25

Materials

aluminium 1M | 2M | 46

Ref

5055.1M	white tex
5055.2M	black tex
5055.46	grey-brown

built-up

5056/.. - MAESTRO

~230V

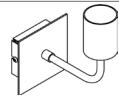

built-up wall light - fixed - with E27 lampholder  
Wandleuchte für Aufbau - fest - mit E27 Fassung

Lamp type

1x A60 E27 max. 40W A - E 230V

Dimensions

B85xH85xD160

Base - L60xB60xH25

Materials

aluminium 1M | 2M | 46

Ref

5056.1M	white tex
5056.2M	black tex
5056.46	grey-brown

built-up

5057/.. - MAESTRO

~230V

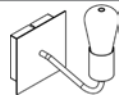

built-up wall light - fixed - with E27 lampholder  
Wandleuchte für Aufbau - fest - mit E27 Fassung

Lamp type

1x A60 E27 max. 40W A - E 230V

Dimensions

B85xH85xD230

Base - L60xB60xH25

Materials

aluminium 1M | 2M | 46

Ref

5057.1M	white tex
5057.2M	black tex
5057.46	grey-brown

built-up

5056.SH/.. - MAESTRO

~230V  IP20    0,2000  0,5 m  05.20.02 

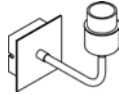

built-up wall light - fixed - with E27 lampholder  
Wandleuchte für Aufbau - fest - mit E27 Fassung

Lamp type

◐ 1x A60 E27 max. 40W  -  230V

Dimensions

↔ B85xH160xD160

Base - L60xB60xH25

Materials

aluminium 1M | 2M | 46

Ref

5056.SH.1M	white tex
5056.SH.2M	black tex
5056.SH.46	grey-brown

built-up  
lampshade not included  
Lampenschirm nicht einbegriffen

5056.2SH/.. - MAESTRO

~230V  IP20    0,4400  0,5 m  05.20.02 

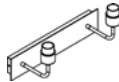

built-up wall light - fixed - with E27 lampholder  
Wandleuchte für Aufbau - fest - mit E27 Fassung

Lamp type

◐ 2x A60 E27 max. 10,5W  -  230V

or ◐ 2x ST64 E27 max. 40W  -  230V

Dimensions

↔ B400xH160xD160

Base - B375xH60xD25

Materials

aluminium 1M | 2M | 46

Ref

5056.2SH.1M	white tex
5056.2SH.2M	black tex
5056.2SH.46	grey-brown

built-up  
lampshade not included  
Lampenschirm nicht einbegriffen

5057.SH/.. - MAESTRO

~230V  IP20    0,4400  0,5 m  05.20.02 

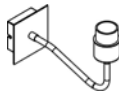

built-up wall light - fixed - with E27 lampholder  
Wandleuchte für Aufbau - fest - mit E27 Fassung

Lamp type

◐ 1x A60 E27 max. 40W  -  230V

Dimensions

↔ B85xH160xD230

Base - L60xB60xH25

Materials

aluminium 1M | 2M | 46

Ref

5057.SH.1M	white tex
5057.SH.2M	black tex
5057.SH.46	grey-brown

built-up  
lampshade not included  
Lampenschirm nicht einbegriffen

5057.2SH/.. - MAESTRO

~230V  IP20    0,5  0,5 m  05.20.02 



built-up wall light - fixed - with E27 lampholder  
Wandleuchte für Aufbau - fest - mit E27 Fassung

Lamp type

◐ 1x A60 E27 max. 40W  -  230V

Dimensions

↔ B85xH160xD230

Base - L375xB60xH25

Materials

aluminium 1M | 2M | 46

Ref

5057.2SH.1M	white tex
5057.2SH.2M	black tex
5057.2SH.46	grey-brown

built-up  
lampshade not included  
Lampenschirm nicht einbegriffen

5061SH/.. - MAESTRO

~230V  IP20    0,5 m  05.20.02 



built-up wall light - fixed - with E27 lampholder  
Wandleuchte für Aufbau - fest - mit E27 Fassung

**Lamp type**  
◐ 1x A60 E27 max. 28W  -  230V

**Dimensions**  
↔ B60xH110xD140  
Base - B60xH60xD25

**Materials**  
aluminium 1M | 2M

**Ref**  
5061SH.1M white tex  
5061SH.2M black tex

built-up  
lampshade not included  
Lampenschirm nicht einbegriffen

5026SH/.. - MAESTRO

~230V  IP20    0,5900 0,5 m  05.20.02 



built-up wall light - directional - with articulated arm  
Wandleuchte für Aufbau - schwenkbar - mit faltbare Arm

**Lamp type**  
◐ 1x A60 E27 max. 40W  -  230V

**Dimensions**  
↔ B40xH190xD350  
Base - B40xH120xD20

**Materials**  
aluminium 1M | 2M | 46 | 33M

**Ref**  
5026SH.1M white tex  
5026SH.2M black tex  
5026SH.33M brown texture  
5026SH.46 grey-brown

built-up  
lampshade not included  
Lampenschirm nicht einbegriffen

5026/.. - MAESTRO

~230V  IP20    0,5 m  05.20.02 



built-up wall light - directional - with articulated arm  
Wandleuchte für Aufbau - schwenkbar - mit faltbare Arm

**Lamp type**  
◐ 1x A60 E27 max. 40W  -  230V

**Dimensions**  
↔ B40xH190xD350  
Base - B40xH120xD20

**Materials**  
aluminium 1M | 2M | 46 | 33M

**Ref**  
5026.1M white tex  
5026.2M black tex  
5026.33M brown texture  
5026.46 grey-brown

built-up



5034SH../ - MAESTRO

~230V  IP20    0.5 m  05.20.02 

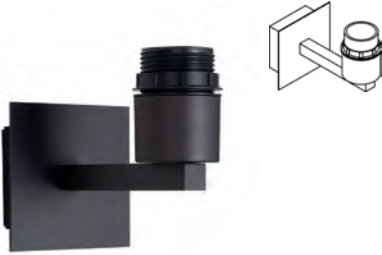

built-up wall light - fixed - with E27 lampholder  
Wandleuchte für Aufbau - fest - mit E27 Fassung

<b>Lamp type</b>	230V
◀ 1x A60 E27 max. 40W 	
<b>Dimensions</b>	
↔ B85xH85xD160	
Base - L60xB60xH25	
<b>Materials</b>	
aluminium	1M   2M   46

<b>Ref</b>	
5034SH.1M	white tex
5034SH.2M	black tex
5034SH.46	grey-brown

built-up  
lampshade not included  
Lampenschirm nicht einbegriffen

5036SH../ - MAESTRO

~230V  IP20    0.5 m  05.20.02 



built-up wall light - fixed - with E27 lampholder  
Wandleuchte für Aufbau - fest - mit E27 Fassung

<b>Lamp type</b>	230V
◀ 1x A60 E27 max. 40W 	
<b>Dimensions</b>	
↔ B75xH125xD160	
Base - L60xB110xH25	
<b>Materials</b>	
aluminium	1M   2M   46   33M

<b>Ref</b>	
5036SH.1M	white tex
5036SH.2M	black tex
5036SH.33M	brown texture
5036SH.46	grey-brown

built-up  
lampshade not included  
lampshade not included

5035SH../ - MAESTRO

~230V  IP20    0.5 m  05.20.02 



built-up wall light - fixed - with E27 lampholder  
Wandleuchte für Aufbau - fest - mit E27 Fassung

<b>Lamp type</b>	230V
◀ 1x A60 E27 max. 40W 	
<b>Dimensions</b>	
↔ B125xH75xD150	
Base - L111xB60xH25	
<b>Materials</b>	
aluminium	1M   2M   46

<b>Ref</b>	
5035SH.1M	white tex
5035SH.2M	black tex
5035SH.46	grey-brown

built-up  
lampshade not included  
Lampenschirm nicht einbegriffen

5034.2SH../ - MAESTRO

~230V  IP20    0.5 m  05.20.02 

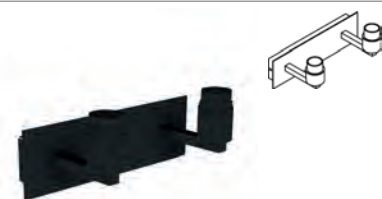

built-up wall light - fixed - with E27 lampholder  
Wandleuchte für Aufbau - fest - mit E27 Fassung

<b>Lamp type</b>	230V
◀ 1x A60 E27 max. 40W 	
<b>Dimensions</b>	
↔ B400xH90xD160	
Base - L60xB60xH25	
<b>Materials</b>	
aluminium	1M   2M   46

<b>Ref</b>	
5034.2SH.1M	white tex
5034.2SH.2M	black tex
5034.2SH.46	grey-brown

built-up  
lampshade not included  
Lampenschirm nicht einbegriffen

5102/.. - MAESTRO

~230V IP20 0,5 m 05.20.02 CE



built-up wall light - fixed  
Wandleuchte für Aufbau - fest

**Lamp type**

1x G95 E27 max. 10,5W **A+** - **E** 230V

**Dimensions**

B110xH320xD220

Base - Ø110xD35

**Materials**

aluminium 1M | 2M

**Ref**

5102.1M	white tex
5102.2M	black tex
5102.2M.16	black tex

built-up

5106/.. - MAESTRO

~230V IP20 0,5 m 05.20.02 CE



built-up wall light - fixed  
Wandleuchte für Aufbau - fest

**Lamp type**

1x G95 E27 max. 10,5W **A+** - **E** 230V

**Dimensions**

B220xH480xD220

Base - Ø110xD55

**Materials**

aluminium 1M | 2M

**Ref**

5106.1M	white tex
5106.2M	black tex
5106.2M.16	black tex

built-up



1819.DOWN/.. - OLIVIA

~230V        1,6600  1 m  05.20.50 





built-up wall light - directional - with transformer - with LED driver  
Wandleuchte für Aufbau - schwenkbar - mit Trafo - mit Driver LED

Lamp type

 1x QR-LP111 G53 max. 50W  -  12V  
 1x powered 350mA max. 1W  -  350mA

Dimensions

 Ø162xH154xD200  
 B80xH60

Ref

1819.DOWN.1M	B   CW   WW
1819.DOWN.2M	A   B   CW   WW
1819.DOWN.11M.B	B   CW   WW
1819.DOWN.2M.7	A   B   CW   WW
1819.DOWN.11M.14	B   CW   WW

built-up  
only dimmable on 2 circuits  
nur dimmbar bei 2 Stromkreise



1819.UP/.. - OLIVIA

~230V   IP20     1,6400  0,5 m  05.20.02 





built-up wall light - directional - without LED - with transformer  
Wandleuchte für Aufbau - schwenkbar - ohne LED - mit Trafo

Lamp type

 1x QPAR111 GU10 max. 75W  -  240V

Dimensions

 Ø162xH154xD200  
 B80xH60

Materials

aluminium 1M | 2M | 11M

Ref

1819.UP.1M	white tex
1819.UP.2M	black tex
1819.UP.2M.7	black tex
1819.UP.11M	grey tex
1819.UP.11M.14	grey tex

built-up

1920.ES50/.. - OLIVIA MINI UP

~230V  IP20    1 m  05.20.02 





built-up wall light - fixed - up  
Wandleuchte für Aufbau - fest - up

Lamp type

 1x QPAR 51 GU10 max. 20W  -  230V

Dimensions

 Ø100xH145xD135  
 B50xH30

Materials

aluminium 14 | 1M | 2M  
brass 13 | 23

Ref

1920.ES50.1M	white tex
1920.ES50.2M	black tex
1920.ES50.13	bronze
1920.ES50.14	alu satin
1920.ES50.23	dark bronze

built-up

1920.E27/.. - OLIVIA MINI UP

~230V  IP20    0,2650  1 m  05.20.02 

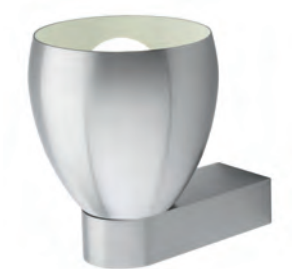



built-up wall light - fixed - up  
Wandleuchte für Aufbau - fest - up

Lamp type

 1x TC-SEI E27 max. 11W  -  230V

Dimensions

 Ø100xH145xD135  
 B50xH30

Materials

aluminium 14 | 1M | 2M  
brass 13 | 23

Ref

1920.E27.1M	white tex
1920.E27.2M.28	black tex
1920.E27.13	bronze
1920.E27.14	alu satin
1920.E27.23	dark bronze

built-up

WALL UP

1921.ES50/.. - OLIVIA MINI DOWN

~230V



built-up wall light - fixed - down  
Wandleuchte für Aufbau - fest - down

**Lamp type**

1x QPAR 51 GU10 max. 20W A - E 230V

**Dimensions**

Ø100xH145xD135

B50xH30

**Materials**

aluminium 14 | 1M | 2M  
brass 13 | 23

**Ref**

1921.ES50.1M	white tex
1921.ES50.2M	black tex
1921.ES50.13	bronze
1921.ES50.14	alu satin
1921.ES50.23	dark bronze

built-up

1921.E27/.. - OLIVIA MINI DOWN

~230V



built-up wall light - fixed - down  
Wandleuchte für Aufbau - fest - down

**Lamp type**

1x TC-SEI E27 max. 11W A - B 230V

**Dimensions**

Ø100xH145xD135

B50xH30

**Materials**

aluminium 14 | 1M | 2M  
brass 13 | 23

**Ref**

1921.E27.1M	white tex
1921.E27.2M	black tex
1921.E27.13	bronze
1921.E27.14	alu satin
1921.E27.23	dark bronze

built-up



WALL UP



954/.. - OPERA

~230V   IP20     1,0150  1 m  05.20.02 



built-up ceiling or wall light - directional - with transformer  
Decken- oder Wandleuchte für Aufbau - schwenkbar - mit Trafo

Lamp type

1x QR-LP111 G53 max. 12W  12V  
or 1x PAR 36 screw max. 50W  12V

Dimensions

L170xB177xH90  
L170xB40

Materials

aluminium 14 | 1M | 2M

Ref

954.1M white tex  
954.2M black tex  
954.14 alu satin

built-up

953/.. - OPERA

~230V   IP20     1,7050  1 m  05.20.02 



built-up ceiling or wall light - directional - with transformer  
Decken- oder Wandleuchte für Aufbau - schwenkbar - mit Trafo

Lamp type

2x QR-LP111 G53 max. 12W  12V  
or 2x PAR 36 screw max. 50W  12V

Dimensions

L310xB177xH90  
L310xB40

Materials

aluminium 14 | 1M | 2M

Ref

953.1M white tex  
953.2M black tex  
953.14 alu satin

built-up



955/.. - OPERA

~230V   IP20     2,4600  1 m  05.20.02 



built-up ceiling or wall light - directional - with transformer  
Decken- oder Wandleuchte für Aufbau - schwenkbar - mit Trafo

Lamp type

3x QR-LP111 G53 max. 12W  12V  
or 3x PAR 36 screw max. 50W  12V

Dimensions

L460xB177xH90  
L460xB40

Materials

aluminium 14 | 1M | 2M

Ref

955.1M white tex  
955.2M black tex  
955.14 alu satin

built-up



956/.. - OPERA

~230V   IP20     3,2000  1 m  05.20.02 



built-up ceiling or wall light - directional - with transformer  
Decken- oder Wandleuchte für Aufbau - schwenkbar - mit Trafo

Lamp type

4x QR-LP111 G53 max. 12W  12V  
or 4x PAR 36 screw max. 50W  12V

Dimensions

L605xB177xH90  
L605xB40

Materials

aluminium 14 | 1M | 2M

Ref

956.1M white tex  
956.2M black tex  
956.14 alu satin

built-up

4010/.. - OPERA

~230V



built-up wall light - directional - with transformer  
Wandleuchte für Aufbau - schwenkbar - mit Trafo

Lamp type

4x QR-LP111 G53 max. 12W A - C 12V  
or 4x PAR 36 screw max. 50W E 12V

Dimensions

B410xH364xD545  
Ø100

Materials

aluminium 14 | 1M | 2M

Ref

4010.1M	white tex
4010.2M	black tex
4010.14	alu satin

built-up



WALL UP

# INDOOR | Wall UP | UNO - DUO

LED colors: cool white 6000K (CW) - 3000K warm white (WW) neutral white 4000K (NW) Other LED colors on request

LED-Farben: kühles Weiß 6000K (CW) - 3000K warmweiß (WW) neutral weiß 4000K (NW) Andere LED-Farben auf Anfrage

## 3082.10/.. - DUO

~230V



built-up wall light - down/up - with LED driver  
Wandleuchte für Aufbau - down/up - mit Driver LED

### Lamp type

2x powered 700mA max. 3W A - A+ 700mA

### Dimensions

B45xH104xD60 10° reflector

### Ref

3082.10.1M	CW   WW
3082.10.2M	CW   WW
3082.10.14	CW   NW

built-up  
other °angle reflector on demand  
andere °Winkel Reflektor auf Anfrage

## 3082.40/.. - DUO

~230V



built-up wall light - down/up - with LED driver  
Wandleuchte für Aufbau - down/up - mit Driver LED

### Lamp type

2x powered 700mA max. 3W A - A+ 700mA

### Dimensions

B45xH104xD60 40° reflector

### Ref

3082.40.1M	CW   WW
3082.40.2M	CW   WW
3082.40.14	CW   WW

built-up  
other °angle reflector on demand  
andere °Winkel Reflektor auf Anfrage

## 3081.10/.. - UNO

=700mA



built-up wall light - down - without LED driver  
Wandleuchte für Aufbau - down - ohne Driver LED

### Lamp type

1x powered 700mA max. 3W A - A+ 700mA

### Dimensions

B45xH60xD60 10° reflector

### Ref

3081.10.1M	CW   WW
3081.10.2M	CW   WW
3081.10.14	CW   WW

built-up  
other °angle reflector on demand  
andere °Winkel Reflektor auf Anfrage

## 3081.40/.. - UNO

=700mA



built-up wall light - down - without LED driver  
Wandleuchte für Aufbau - down - ohne Driver LED

### Lamp type

1x powered 700mA max. 3W A - A+ 700mA

### Dimensions

B45xH60xD60 40° reflector

### Ref

3081.40.1M	CW   WW
3081.40.2M	CW   WW
3081.40.14	CW   WW

built-up  
other °angle reflector on demand  
andere °Winkel Reflektor auf Anfrage



LED colors: cool white 6000K (CW) - 3000K warm white (WW) neutral white 4000K (NW) Other LED colors on request

LED-Farben: kühles Weiß 6000K (CW) - 3000K warmweiß (WW) neutral weiß 4000K (NW) Andere LED-Farben auf Anfrage

**W3082.10/.. - DUO**

~230V    IP44     0,6200  0,5 m  05.20.50 



built-up wall light - down/up - with LED driver  
Wandleuchte für Aufbau - down/up - mit Driver LED





**Lamp type**  
2x powered 700mA max. 3W  -  700mA

**Dimensions**  
B45xH104xD60  10° reflector

Ref	
W3082.10.31MA	CW   WW
W3082.10.32A	CW   WW
W3082.10.40	CW   WW



built-up  
other °angle reflector on demand  
andere °Winkel Reflektor auf Anfrage

**W3082.40/.. - DUO**

~230V    IP44     0,3200  0,5 m  05.20.50 



built-up wall light - down/up - with LED driver  
Wandleuchte für Aufbau - down/up - mit Driver LED

**Lamp type**  
2x powered 700mA max. 3W  -  700mA

**Dimensions**  
B45xH104xD60  40° reflector

Ref	
W3082.40.31MA	CW   WW
W3082.40.32A	CW   WW
W3082.40.40	CW   WW

built-up  
other °angle reflector on demand  
andere °Winkel Reflektor auf Anfrage



WALL UP



3010/.. - VITO

~12V



built-up wall light - up or down - without transformer  
Wandleuchte für Aufbau - up or down - ohne Trafo

Lamp type

1x QR-CB 51 GU5,3/GX5,3 max. 50W **A+** - **E** 12V

Dimensions

Ø55xH125xD100  
B40xH55

Materials

aluminium 1 | 2 | 11 | 14 | 1M | 2M  
brass 4 | 13 | 16 | 23

Ref

3010.1	white
3010.1M	white tex
3010.2	black
3010.2M	black tex
3010.4	shiny gold
3010.11	alu grey
3010.13	bronze
3010.14	alu satin
3010.16	satin gold
3010.23	dark bronze

built-up  
use coolfit lamp  
Coolfit-Lampe verwenden

3010.ES50/.. - VITO

~230V

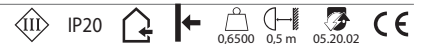

built-up wall light - up or down  
Wandleuchte für Aufbau - up or down

Lamp type

1x QPAR 51 GU10 max. 20W **A+** - **E** 230V

Dimensions

Ø55xH125xD100  
B40xH55

Materials

aluminium 1 | 2 | 11 | 14 | 1M | 2M  
brass 4 | 13 | 16 | 23

Ref

3010.ES50.1	white
3010.ES50.1M	white tex
3010.ES50.2	black
3010.ES50.2M	black tex
3010.ES50.4	shiny gold
3010.ES50.11	alu grey
3010.ES50.13	bronze
3010.ES50.14	alu satin
3010.ES50.16	satin gold
3010.ES50.23	dark bronze

built-up  
use coolfit lamp  
Coolfit-Lampe verwenden

3011/.. - VITO

~230V



built-up wall light - up or down - with transformer  
Wandleuchte für Aufbau - up or down - mit Trafo

Lamp type

1x QR-CB 51 GU5,3/GX5,3 max. 35W **A+** - **E** 12V

Dimensions

Ø55xH125xD100  
B40xH117

Materials

aluminium 1 | 2 | 11 | 14 | 1M | 2M  
brass 4 | 13 | 16 | 23

Ref

3011.1	white
3011.1M	white tex
3011.2	black
3011.2M	black tex
3011.4	shiny gold
3011.11	alu grey
3011.13	bronze
3011.14	alu satin
3011.16	satin gold
3011.23	dark bronze

built-up  
60VA - use coolfit lamp  
Coolfit-Lampe verwenden

3012/.. - VITO

~12V



built-up wall light - down/up - without transformer  
Wandleuchte für Aufbau - down/up - ohne Trafo

Lamp type

2x QR-CB 51 GU5,3/GX5,3 max. 50W **A+** - **E** 12V

Dimensions

Ø55xH150xD100  
B40xH55

Materials

aluminium 1 | 2 | 11 | 14 | 1M | 2M  
brass 4 | 13 | 16 | 23

Ref

3012.1	white
3012.1M	white tex
3012.2	black
3012.2M	black tex
3012.4	shiny gold
3012.11	alu grey
3012.13	bronze
3012.14	alu satin
3012.16	satin gold
3012.23	dark bronze

built-up  
use coolfit lamp  
Coolfit-Lampe verwenden

3012.ES50/.. - VITO

~230V



built-up wall light - down/up  
Wandleuchte für Aufbau - down/up

Lamp type

2x QPAR 51 GU10 max. 20W **A+** - **E** 230V

Dimensions

Ø55xH150xD100

B40xH55

Materials

aluminium 1 | 2 | 11 | 14 | 1M | 2M  
brass 4 | 13 | 16 | 23

Ref

3012.ES50.1	white
3012.ES50.1M	white tex
3012.ES50.2	black
3012.ES50.2M	black tex
3012.ES50.4	shiny gold
3012.ES50.11	alu grey
3012.ES50.13	bronze
3012.ES50.14	alu satin
3012.ES50.16	satin gold
3012.ES50.23	dark bronze

built-up  
use coolfit lamp  
Coolfit-Lampe verwenden

3013/.. - VITO

~230V



built-up wall light - down/up - with transformer  
Wandleuchte für Aufbau - down/up - mit Trafo

Lamp type

2x QR-CB 51 GU5,3/GX5,3 max. 20W **A+** - **E** 12V

Dimensions

Ø55xH150xD100

B40xH117

Materials

aluminium 1 | 2 | 11 | 14 | 1M | 2M  
brass 4 | 13 | 16 | 23

Ref

3013.1	white
3013.1M	white tex
3013.2	black
3013.2M	black tex
3013.4	shiny gold
3013.11	alu grey
3013.13	bronze
3013.14	alu satin
3013.16	satin gold
3013.23	dark bronze

built-up  
60VA - use coolfit lamp  
Coolfit-Lampe verwenden





3984/.. - JACOB

~230V   IP20  0.5 m  05.20.50 



built-up wall light - round - fixed - down/up - with LED driver  
Wandleuchte für Aufbau - rund - fest - down/up - mit Driver LED

**Lamp type**  
2x led 467lm CRI80 max. 3,8W  -  350mA

**Dimensions**  
B40xH250xD85  48° reflector  
B35xH190xD35  
Tube - Ø40xH250

Ref	
3984.1M	NW   WW
3984.2M	NW   WW
3984.29	NW   WW
3984.49	NW   WW

built-up

1176/.. - BROOKLYN

~230V  IP20  0.5 m  05.20.02 



built-up wall light - square - fixed  
Wandleuchte für Aufbau - viereckig - fest

**Lamp type**  
1x S14D E27 max. 12W  230V

**Dimensions**  
L85xB35xD50

**Materials**  
aluminium 1M | 2M  
brass 13 | 16 | 23

Ref	
1176.1M	white tex
1176.2M	black tex
1176.13	bronze
1176.16	satin gold
1176.23	dark bronze

built-up

WALL UP

1783/.. - ENSOR

~230V



built-up wall light - fixed - down/up  
Wandleuchte für Aufbau - fest - down/up

Lamp type

2x QPAR 51 GU10 max. 20W A+ - E 230V

Dimensions

B208xH208xD99

Materials

aluminium 1M | 2M

Ref

1783.1M white tex  
1783.2M black tex

built-up

1784/.. - ENSOR

~230V

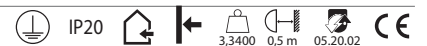

built-up wall light - fixed - down/up  
Wandleuchte für Aufbau - fest - down/up

Lamp type

2x QPAR 51 GU10 max. 20W A+ - E 230V

Dimensions

B235xH208xD106

Materials

aluminium 1M | 2M

Ref

1784.1M white tex  
1784.2M black tex

built-up

1785/.. - ENSOR

~230V

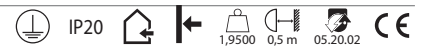

built-up wall light - fixed - down/up  
Wandleuchte für Aufbau - fest - down/up

Lamp type

2x QPAR 51 GU10 max. 20W A+ - E 230V

Dimensions

B211xH208xD102

Materials

aluminium 1M | 2M

Ref

1785.1M white tex  
1785.2M black tex

built-up

1994/.. - PROJECTA

~230V

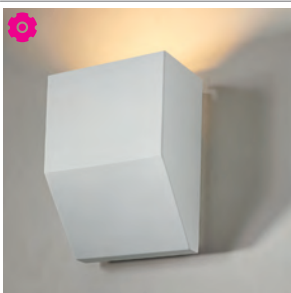

XICATO

built-up wall light - fixed - up - with led - with LED driver  
Wandleuchte für Aufbau - fest - up - mit Led - mit Driver LED

Lamp type

1x Led 3000lm CRI80 max. 41,4W A+ 1050mA

Dimensions

B190xH250xD130  $\wedge$  85° reflector

Materials

aluminium 11M

Ref

1994.1M.WW white tex  
1994.2M.WW black tex  
1994.11M.WW grey tex

built-up





1780.IP20/.. - ENSOR XICATO

~230V   IP20    2,6500  0,5 m  05.20.50 



built-up wall light - down/up - with led - with LED driver  
Wandleuchte für Aufbau - down/up - mit Led - mit Driver LED

**Lamp type**  
2x Led 965lm CRI80 max. 6,6W  -  500mA

**Dimensions**  
B208xH208xD99

Ref	
1780.IP20.1M	NW   WW
1780.IP20.2M	NW   WW



built-up  
dimmable on request  
dimmbar auf Anfrage

1781.IP20/.. - ENSOR XICATO

~230V   IP20    4,0100  0,5 m  05.20.50 



built-up wall light - down/up - with led - with LED driver  
Wandleuchte für Aufbau - down/up - mit Led - mit Driver LED

**Lamp type**  
2x Led 965lm CRI80 max. 6,6W  -  500mA

**Dimensions**  
B235xH208xD106

Ref	
1781.IP20.1M	NW   WW
1781.IP20.2M	NW   WW



built-up  
dimmable on request  
dimmbar auf Anfrage

1782.IP20/.. - ENSOR XICATO

~230V   IP20    2,2100  0,5 m  05.20.50 



built-up wall light - down/up - with led - with LED driver  
Wandleuchte für Aufbau - down/up - mit Led - mit Driver LED

**Lamp type**  
2x Led 965lm CRI80 max. 6,6W  -  500mA

**Dimensions**  
B211xH208xD102

Ref	
1782.IP20.1M	NW   WW
1782.IP20.2M	NW   WW



built-up  
dimmable on request  
dimmbar auf Anfrage

1782B.IP20/.. - ENSOR XICATO

~230V   IP20    0,5 m  05.20.50 



built-up wall light - down/up - with LED driver  
Wandleuchte für Aufbau - down/up - mit Driver LED

**Lamp type**  
1x Led 965lm CRI80 max. 6,6W  -  500mA

**Dimensions**  
B211xH150xD102

Ref	
1782B.IP20.1M	NW
1782B.IP20.2M	NW
1782B.IP20.45	NW

built-up  
dimmable on request  
dimmbar auf Anfrage

3004.DISCUS.ES50/.. - COMMA 230V - M10

~230V  IP20     0,1700  0,5 m  05.20.02 



built-up spot M10 - directional  
Aufbaustrahler M10 - schwenkbar

**Lamp type**

 1x QPAR 51 GU10 max. 20W  -  **230V**

**Dimensions**

 Ø51xH455 - 500

**Materials**

aluminium 1 | 2 | 11 | 14 | 1M | 2M  
brass 4 | 13 | 16

**Ref**

3004.DISCUS.ES50.1	white
3004.DISCUS.ES50.1M	white tex
3004.DISCUS.ES50.2	black
3004.DISCUS.ES50.2M	black tex
3004.DISCUS.ES50.4	shiny gold
3004.DISCUS.ES50.11	alu grey
3004.DISCUS.ES50.13	bronze
3004.DISCUS.ES50.14	alu satin
3004.DISCUS.ES50.16	satin gold

**built-up**

standard 500mm - 200-300-400mm on request  
standard 500mm - 200-300-400mm auf Anfrage

3004.STEP.ES50/.. - COMMA 230V - M10



~230V  IP20     0,4300  0,5 m  05.20.02 



built-up spot M10 - directional  
Aufbaustrahler M10 - schwenkbar

**Lamp type**

 1x QPAR 51 GU10 max. 20W  -  **230V**

or  1x QPAR70 GU10 max. 7W  **230V**

**Dimensions**

 Ø51xH455 - 500

**Materials**

aluminium 1 | 2 | 11 | 14 | 1M | 2M | 11M  
brass 4 | 13 | 16

**Ref**

3004.STEP.ES50.1	white
3004.STEP.ES50.1M	white tex
3004.STEP.ES50.2	black
3004.STEP.ES50.2M	black tex
3004.STEP.ES50.4	shiny gold
3004.STEP.ES50.11	alu grey
3004.STEP.ES50.11M	grey tex
3004.STEP.ES50.13	bronze
3004.STEP.ES50.14	alu satin
3004.STEP.ES50.16	satin gold

**built-up**

standard 500mm - 200-300-400mm on request  
standard 500mm - 200-300-400mm auf Anfrage



WALL UP





**3006.T/.. - DISPLAY**

~230V   IP20    3,0000  0,5 m  05.20.02 



display lighting - directional - clip max 35mm - with transformer  
 Beleuchtung für Schaufenster - schwenkbar - clip max 35mm - mit Trafo

Ref	
3006.T.1	white
3006.T.2	black
3006.T.11	alu grey

**Lamp type**  
 1x QR-CB 51 GU5,3/GX5,3 max. 50W  -  12V

**Dimensions**  
 Ø51xH590 - Bar 500

**Materials**  
 aluminium 1 | 2 | 11

**built-up**  
 60VA - other lengths available on request - straight rod + knee joint  
 andere Längen auf Anfrage - gerade Stange + Kniegelenk



**3007.DISCUS.25/.. - DISPLAY**

~230V   IP20    0,6000  0,5 m  05.20.02 



display lighting - clip 25mm - with transformer  
 Beleuchtung für Schaufenster - clip 25mm - mit Trafo

Ref	
3007.DISCUS.25.1	white
3007.DISCUS.25.2	black
3007.DISCUS.25.11	alu grey
3007.DISCUS.25.14	alu satin

**Lamp type**  
 1x QR-CB 51 GU5,3/GX5,3 max. 50W  -  12V

**Dimensions**  
 Ø51xH590 - Bar 500  
 B50xH75xD40

**Materials**  
 aluminium 1 | 2 | 11 | 14

**built-up**  
 60VA - cable 1,5m - curved rod  
 Kabel 1,5m - gekrümmte Stange



**3007.JUPITER.25/.. - DISPLAY**



~230V   IP20    0,5 m  05.20.02 



display lighting - clip 25mm - with transformer  
 Beleuchtung für Schaufenster - clip 25mm - mit Trafo

Ref	
3007.JUPITER.25.1	white
3007.JUPITER.25.2	black
3007.JUPITER.25.11	alu grey
3007.JUPITER.25.14	alu satin

**Lamp type**  
 1x QR-CB 51 GU5,3/GX5,3 max. 50W  -  12V

**Dimensions**  
 Ø51xH590 - Bar 500  
 B50xH75xD40

**Materials**  
 aluminium 1 | 2 | 11 | 14

**built-up**  
 60VA - cable 1,5m - curved rod  
 Kabel 1,5m - gekrümmte Stange



**3007.STEP.25/.. - DISPLAY**



~230V   IP20    0,5 m  05.20.02 



display lighting - clip 25mm - with transformer  
 Beleuchtung für Schaufenster - clip 25mm - mit Trafo

Ref	
3007.STEP.25.1	white
3007.STEP.25.2	black
3007.STEP.25.11	alu grey
3007.STEP.25.14	alu satin

**Lamp type**  
 1x QR-CB 51 GU5,3/GX5,3 max. 50W  -  12V

**Dimensions**  
 Ø51xH590 - Bar 500  
 B50xH75xD40

**Materials**  
 aluminium 1 | 2 | 11 | 14

**built-up**  
 60VA - cable 1,5m - curved rod  
 Kabel 1,5m - gekrümmte Stange





3008.DISCUS.45/.. - DISPLAY

~230V   IP20    1,5150  0,5 m  05.20.02 



display lighting - clip 45mm - with transformer  
Beleuchtung für Schaufenster - clip 45mm - mit Trafo

**Lamp type**  
1x QR-CB 51 GU5,3/GX5,3 max. 50W  -  12V

**Dimensions**  
D550 - Bar 500  
B50xH75xD40

**Materials**  
aluminium 1 | 2 | 11 | 14

Ref	
3008.DISCUS.45.1	white
3008.DISCUS.45.2	black
3008.DISCUS.45.11	alu grey
3008.DISCUS.45.14	alu satin



**built-up**  
60VA - cable 1,5m - curved rod  
Kabel 1,5m - gekrümmte Stange

3008.JUPITER.45/.. - DISPLAY

~230V   IP20    0,6250  0,5 m  05.20.02 



display lighting - clip 45mm - with transformer  
Beleuchtung für Schaufenster - clip 45mm - mit Trafo

**Lamp type**  
1x QR-CB 51 GU5,3/GX5,3 max. 50W  -  12V

**Dimensions**  
D550 - Bar 500  
B50xH75xD40

**Materials**  
aluminium 1 | 2 | 11 | 14

Ref	
3008.JUPITER.45.1	white
3008.JUPITER.45.2	black
3008.JUPITER.45.11	alu grey
3008.JUPITER.45.14	alu satin



**built-up**  
60VA - cable 1,5m - curved rod  
Kabel 1,5m - gekrümmte Stange

3008.STEP.45/.. - DISPLAY

~230V   IP20    0,6250  0,5 m  05.20.02 



display lighting - clip 45mm - with transformer  
Beleuchtung für Schaufenster - clip 45mm - mit Trafo

**Lamp type**  
1x QR-CB 51 GU5,3/GX5,3 max. 50W  -  12V

**Dimensions**  
D550 - Bar 500  
B50xH75xD40

**Materials**  
aluminium 1 | 2 | 11 | 14

Ref	
3008.STEP.45.1	white
3008.STEP.45.2	black
3008.STEP.45.11	alu grey
3008.STEP.45.14	alu satin

**built-up**  
60VA - cable 1,5m - curved rod  
Kabel 1,5m - gekrümmte Stange



# INDOOR FLOOR UP

# Index

## A

ALFRED 668

## B

BETAPLUS 696

BOOSTER 690

## C

CLEO 673

CUBIC 696

## G

GOTA 699

## H

HANGOVER 690

## J

JACOB 667

JAMES 664-665

## M

MANON 678-681

MAESTRO 674

MOBY 670-672

MONA 674

MONTE CRISTO 698

## O

OPERA 698

ORKA TABLE 696

## P

POLINA 689

POLO 692-695

## S

SHAKE 675-676

SPAZIO 667

## V

VOGUE 683-688

VOGUE XL 688

VOLTA 697





**1106R/.. - JAMES**

~230V IP20 5,2000 0,5 m 05.20.50



table lamp - directional - with cable and plug right - with LED driver  
Tischleuchte - schwenkbar - mit Kabel und Stecker Rechts - mit Driver LED

**Lamp type**

2x led 467lm CRI80 max. 3,8W - 350mA

**Dimensions**

↔ L100xB330xH480 48° reflector  
Base - L100xB150xH10

**Ref**

1106R.1M	NW   WW
1106R.2M	NW   WW
1106R.4	NW   WW
1106R.16	NW   WW

built-up

**1106L/.. - JAMES**

~230V IP20 0,5 m 05.20.50



table lamp - directional - with cable and plug left - with LED driver  
Tischleuchte - schwenkbar - mit Kabel und Stecker Links - mit Driver LED

**Lamp type**

2x led 467lm CRI80 max. 3,8W - 350mA

**Dimensions**

↔ L100xB330xH480 48° reflector  
Base - L100xB150xH10

**Ref**

1106L.1M	NW   WW
1106L.2M	NW   WW
1106L.4	NW   WW
1106L.16	NW   WW

built-up

1107R/.. - JAMES



~230V    IP20    8,5600  0,5 m  05.20.50 





built-up

floorlamp - directional - with cable and plug right - with LED driver  
 Stehleuchte - schwenkbar - mit Kabel und Stecker Rechts - mit Driver LED

Lamptype

 2x led 467lm CRI80 max. 3,8W  -  350mA

Dimensions

 L160xB400xH1330  48° reflector  
 Base - L160xB225xH10

Ref

1107R.1M	NW   WW
1107R.2M	NW   WW
1107R.4	NW   WW
1107R.16	NW   WW

1107L/.. - JAMES



~230V    IP20    5,6500  0,5 m  05.20.50 





built-up

floorlamp - directional - with cable and plug left - with LED driver  
 Stehleuchte - schwenkbar - mit Kabel und Stecker Links - mit Driver LED

Lamptype

 2x led 467lm CRI80 max. 3,8W  -  350mA

Dimensions

 L160xB400xH1330  48° reflector  
 Base - L160xB225xH10

Ref

1107L.1M	NW   WW
1107L.2M	NW   WW
1107L.4	NW   WW
1107L.16	NW   WW











3961/.. - JACOB

=350mA IP20 2,1000 0,5 m 05.20.50



table lamp - fixed - with cable and plug - with LED driver  
Tischleuchte - fest - mit Kabel und Stecker - mit Driver LED

Lamp type

1x led 467lm CRI80 max. 3,8W - 350mA

Dimensions

Ø160xH400

Ref

3961.1M	NW   WW
3961.2M	NW   WW
3961.29	NW   WW
3961.47	NW   WW

built-up

3049/.. - SPAZIO

~230V IP20 0,5 m 05.20.50



table lamp - with switch - cable and plug  
Tischleuchte - mit Schalter - Kabel und Stecker

Lamp type

1x LED 1300lm CRI80 max. 12W 230V

Dimensions

Ø200xH470

Base - Ø160

Materials

aluminium 29 | 2M | 47

Ref

3049.2M.WW	black tex
3049.29.WW	black - gold in
3049.47.WW	black - white in

built-up

1132/.. - ALFRED

~230V

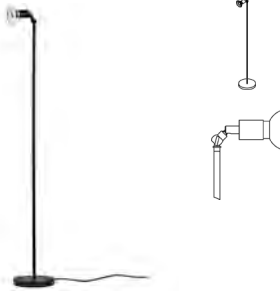

floorlamp - directional - with cable and plug  
Stehleuchte - schwenkbar - mit Kabel und Stecker

Lamp type

1x QPAR 51 GU10 max. 20W **A+** - **E** 230V  
or 1x QPAR70 GU10 max. 7W **A+** 230V

Dimensions

Ø170xH1000 - Bar 1000

Materials

aluminium 1M | 2M  
brass 16

Ref

1132.1M white tex  
1132.2M black tex  
1132.16 satin gold

built-up

1329/.. - ALFRED

~230V



floorlamp - directional - with cable and plug  
Stehleuchte - schwenkbar - mit Kabel und Stecker

Lamp type

1x QPAR 51 GU10 max. 20W **A+** - **E** 230V  
or 1x QPAR70 GU10 max. 8W **A+** 230V

Dimensions

Ø170xH1000 - Bar 1000

Materials

aluminium 1M | 2M  
brass 16

Ref

1329.1M white tex  
1329.2M black tex  
1329.16 satin gold

built-up

1338/.. - ALFRED

~230V

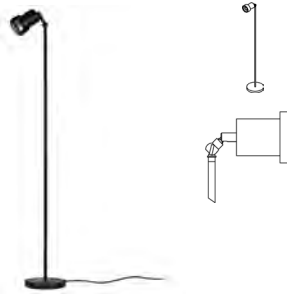

floorlamp - directional - with cable and plug  
Stehleuchte - schwenkbar - mit Kabel und Stecker

Lamp type

1x QPAR 51 GU10 max. 9W **A+** - **E** 230V  
or 1x QPAR70 GU10 max. 8W **A+** 230V

Dimensions

Ø170xH1000 - Bar 1000

Materials

aluminium 1M | 2M

Ref

1338.1M white tex  
1338.2M black tex

built-up

1349/.. - ALFRED

~230V



floorlamp - directional - with cable and plug  
Stehleuchte - schwenkbar - mit Kabel und Stecker

Lamp type

1x LED AC 700lm CRI92 max. 9,5W **A+** 230V

Dimensions

Ø170xH1000 - Bar 1000

Materials

aluminium 1M | 2M  
brass 16

Ref

1349.1M.NW white tex  
1349.2M.NW black tex  
1349.16.NW satin gold

built-up





991.A.E27.D140/.. - MOBY GLAS Ø140

~230V        



built-up



table lamp - fixed - with switch + cable  
Tischleuchte - fest - mit Schalter + Kabel

Lamp type

1x A60 E27 max. 10,5W  -  230V  
1x G95 E27 max. 10,5W  -  230V

Dimensions

Ø145xH160  
Glass - Ø140  
Base - Ø145xH10

Materials

aluminium 1M | 2M | 53

Ref

991.A.E27.D140.1M.BZ white tex  
991.A.E27.D140.1M.TR white tex  
991.A.E27.D140.1M.SG white tex  
991.A.E27.D140.2M.BZ black tex  
991.A.E27.D140.2M.TR black tex  
991.A.E27.D140.2M.SG black tex  
991.A.E27.D140.53.BZ bronze-brown

991.B.E27.D180/.. - MOBY GLAS Ø180

~230V        





built-up



table lamp - fixed - with switch + cable  
Tischleuchte - fest - mit Schalter + Kabel

Lamp type

1x A60 E27 max. 10,5W  -  230V  
1x G95 E27 max. 10,5W  -  230V

Dimensions

Ø180xH200  
Glass - Ø180  
Base - Ø145xH10

Materials

aluminium 1M | 2M | 53

Ref

991.B.E27.D180.1M.BZ white tex  
991.B.E27.D180.1M.TR white tex  
991.B.E27.D180.1M.SG white tex  
991.B.E27.D180.2M.BZ black tex  
991.B.E27.D180.2M.TR black tex  
991.B.E27.D180.2M.SG black tex  
991.B.E27.D180.53.BZ bronze-brown

991.C.E27.D250/.. - MOBY GLAS Ø250

~230V        



built-up



table lamp - fixed - with switch + cable  
Tischleuchte - fest - mit Schalter + Kabel

Lamp type

1x A60 E27 max. 10,5W  -  230V  
1x G95 E27 max. 10,5W  -  230V

Dimensions

Ø250xH262  
Glass - Ø250  
Base - Ø145xH10

Materials

aluminium 1M | 2M | 53

Ref

991.C.E27.D250.1M.BZ white tex  
991.C.E27.D250.1M.TR white tex  
991.C.E27.D250.1M.SG white tex  
991.C.E27.D250.2M.BZ black tex  
991.C.E27.D250.2M.TR black tex  
991.C.E27.D250.2M.SG black tex  
991.C.E27.D250.53.BZ bronze-brown



1467.C.E27.300/.. - MOBY - VOGUE

~230V  IP20      0,5 m  05.20.02  CE



table lamp - fixed - with switch + cable  
Tischleuchte - fest - mit Schalter + Kabel

Lamp type

-  1x A60 E27 max. 12W A - E 230V
- or  1x G95 E27 max. 10,5W A - E 230V

Dimensions

 Ø250xH560 - Bar 300

Glass - Ø250

Base - Ø160xH20

Materials

aluminium 1M | 2M | 53

Ref

- 1467.C.E27.300.1M.BZ white tex
- 1467.C.E27.300.1M.TR white tex
- 1467.C.E27.300.1M.SG white tex
- 1467.C.E27.300.2M.BZ black tex
- 1467.C.E27.300.2M.TR black tex
- 1467.C.E27.300.2M.SG black tex
- 1467.C.E27.300.53.BZ bronze-brown

built-up

1536.C.E27/.. - MOBY Ø250

~230V  IP20      0,5 m  05.20.02  CE



floorlamp - fixed - with switch + cable  
Stehleuchte - fest - mit Schalter + Kabel

Lamp type

-  1x A60 E27 max. 12W A - E 230V
-  1x G95 E27 max. 10,5W A - E 230V

Dimensions

 Ø260xH1480 - Bar 1200

Glass - Ø250

Base - Ø260xH30

Materials

aluminium 1M | 2M | 53

Ref

- 1536.C.E27.1M.BZ white tex
- 1536.C.E27.1M.TR white tex
- 1536.C.E27.1M.SG white tex
- 1536.C.E27.2M.BZ black tex
- 1536.C.E27.2M.TR black tex
- 1536.C.E27.2M.SG black tex
- 1536.C.E27.53.BZ bronze-brown

built-up

1538.B.E27/.. - MOBY Ø180

~230V  IP20      0,5 m  05.20.02  CE



floorlamp - fixed - with switch + cable  
Stehleuchte - fest - mit Schalter + Kabel

Lamp type

-  1x A60 E27 max. 12W A - E 230V
-  1x G95 E27 max. 10,5W A - E 230V

Dimensions

 Ø260xH1415 - Bar 1200

Glass - Ø180

Base - Ø260xH30

Materials

aluminium 1M | 2M | 53

Ref

- 1538.B.E27.1M.BZ white tex
- 1538.B.E27.1M.TR white tex
- 1538.B.E27.1M.SG white tex
- 1538.B.E27.2M.BZ black tex
- 1538.B.E27.2M.TR black tex
- 1538.B.E27.2M.SG black tex
- 1538.B.E27.53.BZ bronze-brown

built-up

1539.A.E27/.. - MOBY Ø140

~230V  IP20      0,5 m  05.20.02  CE



floorlamp - fixed - with switch + cable  
Stehleuchte - fest - mit Schalter + Kabel

Lamp type

-  1x A60 E27 max. 12W A - E 230V
-  1x G95 E27 max. 10,5W A - E 230V

Dimensions

 Ø260xH1380 - Bar 1200

Glass - Ø140

Base - Ø260xH30

Materials

aluminium 1M | 2M | 53

Ref

- 1539.A.E27.1M.BZ white tex
- 1539.A.E27.1M.TR white tex
- 1539.A.E27.1M.SG white tex
- 1539.A.E27.2M.BZ black tex
- 1539.A.E27.2M.TR black tex
- 1539.A.E27.2M.SG black tex
- 1539.A.E27.53.BZ bronze-brown

built-up



1555.B.E27/.. - MOBY Ø180

~230V  IP20      0,5 m  



built-up

floorlamp - fixed - with switch + cable  
Stehleuchte - fest - mit Schalter + Kabel

Lamp type

-  1x A60 E27 max. 12W  230V
-  1x G95 E27 max. 10,5W  230V

Dimensions

→ Ø4000xH1300 - Bar 1400  
Glass - Ø180  
Base - Ø260xH30

Materials

aluminium 1M | 2M | 53

Ref

- 1555.B.E27.1M.BZ white tex
- 1555.B.E27.1M.TR white tex
- 1555.B.E27.1M.SG white tex
- 1555.B.E27.2M.BZ black tex
- 1555.B.E27.2M.TR black tex
- 1555.B.E27.2M.SG black tex
- 1555.B.E27.53.BZ bronze-brown

1556.A.E27/.. - MOBY Ø140

~230V  IP20      0,5 m  



built-up

floorlamp - fixed - with switch + cable  
Stehleuchte - fest - mit Schalter + Kabel

Lamp type

-  1x A60 E27 max. 12W  230V
-  1x G95 E27 max. 10,5W  230V

Dimensions

→ Ø365xH1260 - Bar 1000  
Glass - Ø250  
Base - Ø260xH30

Materials

aluminium 1M | 2M | 53

Ref

- 1556.A.E27.1M.BZ white tex
- 1556.A.E27.1M.TR white tex
- 1556.A.E27.1M.SG white tex
- 1556.A.E27.2M.BZ black tex
- 1556.A.E27.2M.TR black tex
- 1556.A.E27.2M.SG black tex
- 1556.A.E27.53.BZ bronze-brown

FLOOR UP



1516/.. - CLEO - M12

~230V  IP20   0,5 m  05.20.02 



floorlamp - fixed - with cable and plug  
Stehleuchte - fest - mit Kabel und Stecker

**Lamp type**

3x G95 E27 max. 10,5W  -  230V

**Dimensions**

Ø297xH1400

Base - Ø260

**Materials**

aluminium 1M | 2M

**Ref**

1516.1M	white tex
1516.1M.16	white tex
1516.2M	black tex
1516.2M.16	black tex

built-up

1517.B.E27/.. - CLEO - MOBY - M12

~230V  IP20    0,5 m  05.20.02 

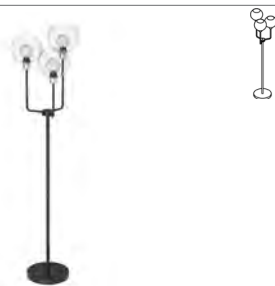

floorlamp - fixed - with cable and plug  
Stehleuchte - fest - mit Kabel und Stecker

**Lamp type**

3x G95 E27 max. 10,5W  -  230V

**Dimensions**

Ø430xH1560

Base - Ø260

Glass - Ø180

**Materials**

aluminium 1M | 2M

**Ref**

1517.B.E27.1M.16.TR	white tex
1517.B.E27.1M.TR	white tex
1517.B.E27.2M.16.BZ	black tex
1517.B.E27.2M.16.SG	black tex
1517.B.E27.2M.16.TR	black tex
1517.B.E27.2M.BZ	black tex
1517.B.E27.2M.TR	black tex
1517.B.E27.2M.SG	black tex

built-up  
other colours of glass on request  
andere glasfarben auf anfrage





4058/.. - MONA

~230V



table lamp - fixed - with cable and plug  
Tischleuchte - fest - mit Kabel und Stecker

Lamp type

1x A60 E27 max. 52W A - E 230V

Dimensions

Ø150xH240

Base - Ø150xH10

Materials

aluminium 14 | 1M | 2M

Ref

4058.1M

4058.2M

4058.14

white tex

black tex

alu satin

built-up

4965/.. - MAESTRO

~230V



floorlamp - fixed  
Stehleuchte - fest

Lamp type

3x A60 E27 max. 10,5W A - E 230V

Dimensions

L250xB250xH1400

Materials

aluminium 1M | 2M

Ref

4965.1M

4965.2M

white tex

black tex

built-up

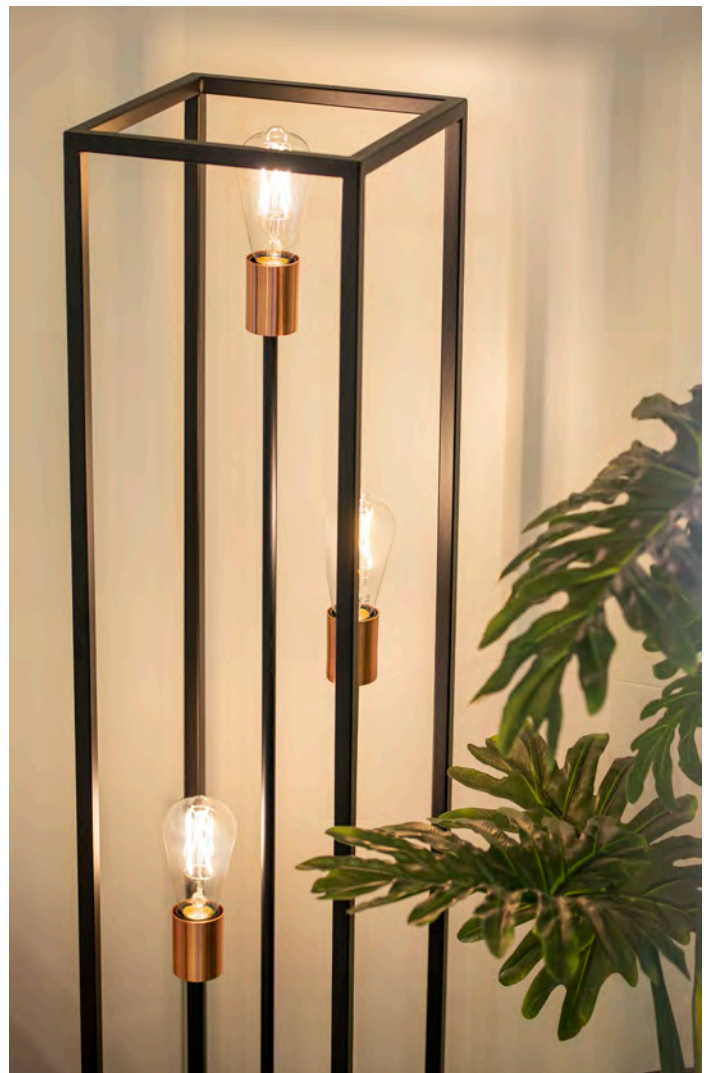

5560.E27/.. - SHAKE GLASS

~230V



table lamp - fixed - with cable and plug  
Tischleuchte - fest - mit Kabel und Stecker

Lamp type

1x A60 E27 max. 12W A - E 230V

Dimensions

Ø150xH182,5

Materials

aluminium 1M | 2M

Ref

5560.E27.1M.TR	white tex
5560.E27.1M.ST	white tex
5560.E27.2M.TR	black tex
5560.E27.2M.ST	black tex

built-up

5561.E27/.. - SHAKE GLASS

~230V



table lamp - fixed - with cable and plug  
Tischleuchte - fest - mit Kabel und Stecker

Lamp type

1x A60 E27 max. 12W A - E 230V

Dimensions

Ø180xH300

Materials

aluminium 1M | 2M

Ref

5561.E27.1M.TR	white tex
5561.E27.1M.ST	white tex
5561.E27.2M.TR	black tex
5561.E27.2M.ST	black tex

built-up



5562.LED/.. - SHAKE METAL

~230V



built-up

floorlamp - directional - with cable and plug  
Stehleuchte - schwenkbar - mit Kabel und Stecker

Lamp type

1x LED 630lm CRI90 max. 6W 230V

Dimensions

Ø330xH1227 - Bar 1000

Base - Ø260xH30

Materials

aluminium 1M | 2M  
aluminium / red copper 228  
brass 16

Ref

5562.LED.1M white tex  
5562.LED.2M black tex  
5562.LED.16 satin gold  
5562.LED.216 black - gold  
5562.LED.228 black - RC

5563.E27/.. - SHAKE GLASS

~230V



built-up

floorlamp - directional - with cable and plug  
Stehleuchte - schwenkbar - mit Kabel und Stecker

Lamp type

1x A60 E27 max. 12W A - E 230V

Dimensions

Ø362xH1262 - Bar 1000

Base - Ø260xH30

Materials

aluminium 1M | 2M

Ref

5563.E27.1M.TR white tex  
5563.E27.1M.ST white tex  
5563.E27.2M.TR black tex  
5563.E27.2M.ST black tex

5564.LED/.. - SHAKE METAL

~230V



built-up

floorlamp - fixed - with cable and plug  
Stehleuchte - fest - mit Kabel und Stecker

Lamp type

1x LED 630lm CRI90 max. 6W 230V

Dimensions

Ø260xH1417 - Bar 1200

Base - Ø260xH30

Ref

5564.LED.1M  
5564.LED.2M  
5564.LED.216  
5564.LED.228

5565.E27/.. - SHAKE GLASS

~230V



built-up

floorlamp - fixed - with cable and plug  
Stehleuchte - fest - mit Kabel und Stecker

Lamp type

1x A60 E27 max. 12W A - E 230V

Dimensions

Ø260xH1452 - Bar 1200

Base - Ø260xH30

Materials

aluminium 1M | 2M

Ref

5565.E27.1M.TR white tex  
5565.E27.1M.ST white tex  
5565.E27.2M.TR black tex  
5565.E27.2M.ST black tex





1557.N.E27/.. - MANON

~230V  IP20       



table lamp - fixed - with cable and plug  
Tischleuchte - fest - mit Kabel und Stecker

Lamp type

1x A60 E27 max. 12W  -  230V

Dimensions

Ø180xH226  
Glass - Ø180xH180  
Base - Ø145xH10

Materials

aluminium 1M | 2M | 53

Ref

1557.N.E27.1M.BZ	white tex
1557.N.E27.1M.TR	white tex
1557.N.E27.1M.ST	white tex
1557.N.E27.2M.BZ	black tex
1557.N.E27.2M.TR	black tex
1557.N.E27.2M.ST	black tex
1557.N.E27.53.BZ	bronze-brown

built-up

1558.P.E27/.. - MANON

~230V  IP20       



table lamp - fixed - with cable and plug  
Tischleuchte - fest - mit Kabel und Stecker

Lamp type

1x IT-32 E27 max. 8W  230V

Dimensions

Ø145xH366,5  
Glass - Ø130xH320  
Base - Ø145xH10

Materials

aluminium 1M | 2M | 53

Ref

1558.P.E27.1M.BZ	white tex
1558.P.E27.1M.TR	white tex
1558.P.E27.1M.ST	white tex
1558.P.E27.2M.BZ	black tex
1558.P.E27.2M.TR	black tex
1558.P.E27.2M.ST	black tex
1558.P.E27.53.BZ	bronze-brown

built-up

FLOOR UP





1562.N.E27/.. - MANON

~230V  IP20      05.20.02 



table lamp - fixed - with cable and plug  
Tischleuchte - fest - mit Kabel und Stecker

Lamp type

1x A60 E27 max. 12W  230V

Dimensions

Ø180xH536,5 - Bar 300

Glass - Ø180xH180

Base - Ø160xH20

Materials

aluminium 1M | 2M | 53

Ref

1562.N.E27.1M.BZ	white tex
1562.N.E27.1M.TR	white tex
1562.N.E27.1M.ST	white tex
1562.N.E27.2M.BZ	black tex
1562.N.E27.2M.TR	black tex
1562.N.E27.2M.ST	black tex
1562.N.E27.53.BZ	bronze-brown

built-up

1563.P.E27/.. - MANON

~230V  IP20      05.20.02 



table lamp - fixed - with cable and plug  
Tischleuchte - fest - mit Kabel und Stecker

Lamp type

1x IT-32 E27 max. 8W  230V

Dimensions

Ø160xH676,5 - Bar 300

Glass - Ø130xH320

Base - Ø160xH20

Materials

aluminium 1M | 2M | 53

Ref

1563.P.E27.1M.BZ	white tex
1563.P.E27.1M.TR	white tex
1563.P.E27.1M.ST	white tex
1563.P.E27.2M.BZ	black tex
1563.P.E27.2M.TR	black tex
1563.P.E27.2M.ST	black tex
1563.P.E27.53.BZ	bronze-brown

built-up

1564.Q.E27/.. - MANON

~230V  IP20      05.20.02 



table lamp - fixed - with cable and plug  
Tischleuchte - fest - mit Kabel und Stecker

Lamp type

1x A60 E27 max. 12W  230V

Dimensions

Ø320xH486,5 - Bar 300

Glass - Ø320xH130

Base - Ø160xH20

Materials

aluminium 1M | 2M | 53

Ref

1564.Q.E27.1M.BZ	white tex
1564.Q.E27.1M.TR	white tex
1564.Q.E27.1M.ST	white tex
1564.Q.E27.2M.BZ	black tex
1564.Q.E27.2M.TR	black tex
1564.Q.E27.2M.ST	black tex
1564.Q.E27.53.BZ	bronze-brown

built-up



1590.N.E27/.. - MANON

~230V  IP20     0,5 m   



floorlamp - fixed - with cable and plug  
Stehleuchte - fest - mit Kabel und Stecker

Lamp type

1x A60 E27 max. 12W  -  230V

Glass - Ø180xH180

Base - Ø260xH30

Materials

aluminium 1M | 2M | 53

Ref

1590.N.E27.1M.BZ	white tex
1590.N.E27.1M.TR	white tex
1590.N.E27.1M.ST	white tex
1590.N.E27.2M.BZ	black tex
1590.N.E27.2M.TR	black tex
1590.N.E27.2M.ST	black tex
1590.N.E27.53.BZ	bronze-brown

built-up

1591.P.E27/.. - MANON

~230V  IP20     8,5000  0,5 m   



floorlamp - fixed - with cable and plug  
Stehleuchte - fest - mit Kabel und Stecker

Lamp type

1x IT-32 E27 max. 8W  230V

Dimensions

Ø260xH1586,5 - Bar 1200

Glass - Ø130xH320

Base - Ø260xH30

Materials

aluminium 1M | 2M | 53

Ref

1591.P.E27.1M.BZ	white tex
1591.P.E27.1M.TR	white tex
1591.P.E27.1M.ST	white tex
1591.P.E27.2M.BZ	black tex
1591.P.E27.2M.TR	black tex
1591.P.E27.2M.ST	black tex
1591.P.E27.53.BZ	bronze-brown

built-up

1592.Q.E27/.. - MANON

~230V  IP20     0,5 m   



floorlamp - fixed - with cable and plug  
Stehleuchte - fest - mit Kabel und Stecker

Lamp type

1x A60 E27 max. 12W  -  230V

Dimensions

Ø320xH1396,5 - Bar 1200

Glass - Ø320xH130

Base - Ø260xH30

Materials

aluminium 1M | 2M | 53

Ref

1592.Q.E27.1M.BZ	white tex
1592.Q.E27.1M.TR	white tex
1592.Q.E27.1M.ST	white tex
1592.Q.E27.2M.BZ	black tex
1592.Q.E27.2M.TR	black tex
1592.Q.E27.2M.ST	black tex
1592.Q.E27.53.BZ	bronze-brown

built-up





990XA/.. - VOGUE

~230V



table lamp - with switch + cable  
Tischleuchte - mit Schalter + Kabel

Lamp type

1x D45 E27 max. 28W A - E 230V

Dimensions

Ø150xH80

Materials

aluminium 14 | 1M | 2M | 46

Ref

990XA.1M	white tex
990XA.2M	black tex
990XA.14	alu satin
990XA.46	grey-brown

built-up

other lengths on demand - lamps not included  
MAX.40W - andere Längen auf Anfrage - Lampe nicht  
einbegriffen

990X/.. - VOGUE

~230V

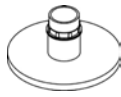

table lamp - fixed - for lampshade - with switch + cable  
Tischleuchte - fest - für Lampenschirm - mit Schalter + Kabel

Lamp type

1x D45 E27 max. 28W A - E 230V

Dimensions

Ø150xH70

Materials

aluminium 14 | 1M | 2M | 46

Ref

990X.1M	white tex
990X.2M	black tex
990X.14	alu satin
990X.46	grey-brown

built-up

lampshade not included  
Lampenschirm nicht einbegriffen

999X/.. - VOGUE

~230V

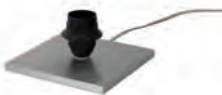

table lamp - without lampshade - with switch + cable  
Tischleuchte - ohne Lampenschirm - mit Schalter + Kabel

Lamp type

1x D45 E27 max. 28W A - E 230V

Dimensions

L150xB150xH50

Materials

aluminium 14 | 1M | 2M | 46

Ref

999X.1M	white tex
999X.2M	black tex
999X.14	alu satin
999X.46	grey-brown

built-up





990/./.. - VOGUE

~230V  IP20    0,5 m  05.20.02 



table lamp - without lampshade - with switch + cable  
Tischleuchte - ohne Lampenschirm - mit Schalter + Kabel

**Materials**  
aluminium

14 | 1M | 2M

**Lamp type**

◀ 1x D45 E27 max. 28W  230V  
Base - Ø145xH10

Colour	990.250/..	990.300/..	990.400/..
	H 250	H 300	H 400
1M			
2M			
14			

*built-up*  
other lengths on demand  
MAX.40W - andere Längen auf Anfrage

990A/./.. - VOGUE

~230V  IP20    0,5 m  05.20.02 



table lamp - without lampshade - with switch + cable  
Tischleuchte - ohne Lampenschirm - mit Schalter + Kabel

**Materials**  
aluminium  
brass

14 | 2M  
13 | 23

**Lamp type**

◀ 1x D45 E27 max. 28W  230V  
Base - Ø170xH12

Colour	990A.250/..	990A.300/..	990A.400/..
	H 250	H 300	H 400
2M			
13.2			
14.11			
23.2			

*built-up*  
socle black or grey - other lengths on demand  
MAX.40W - Sockel Schwarz oder Grau - andere Längen auf Anfrage

FLOOR UP



999/./.. - VOGUE

~230V  IP20     

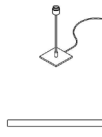
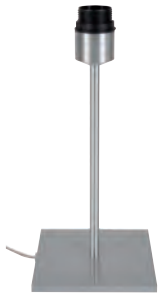

table lamp - without lampshade - with switch + cable  
Tischleuchte - ohne Lampenschirm - mit Schalter + Kabel

Materials  
aluminium

14

Lamp type

◀ 1x D45 E27 max. 28W  230V  
Base - L150xB150xH10

Colour	999.250/..	999.300/..	999.400/..
	H 250	H 300	H 400
	14		

built-up  
other lengths on demand  
MAX.40W - andere Längen auf Anfrage

999A/./.. - VOGUE

~230V  IP20     

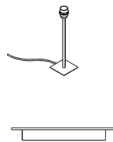

table lamp - without lampshade - with switch + cable  
Tischleuchte - ohne Lampenschirm - mit Schalter + Kabel

Materials  
aluminium  
brass

14 | 2M

13 | 23

Lamp type

◀ 1x D45 E27 max. 28W  230V  
Base - L100xB100xH12

Colour	999A.250/..	999A.300/..	999A.400/..
	H 250	H 300	H 400
	2M.2		
	13.2		
	14.11		
	23.2		

built-up  
socle black or grey - other lengths on demand  
MAX.40W - Sockel Schwarz oder Grau - andere Längen auf Anfrage



FLOOR UP

999C/./.. - VOGUE

~230V  IP20    0,5 m  

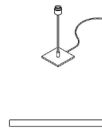

table lamp - without lampshade - with switch + cable  
Tischleuchte - ohne Lampenschirm - mit Schalter + Kabel

Materials  
aluminium

14

Lamp type

◀ 1x D45 E27 max. 28W  -  230V

Dimensions

↔ L80xB80xH10

Colour	999C.250/..	999C.300/..	999C.400/..
	H 250	H 300	H 400
14			

built-up  
other lengths on demand  
MAX.40W - andere Längen auf Anfrage

999B/./.. - VOGUE

~230V  IP20    0,5 m  

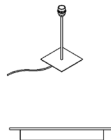

table lamp - without lampshade - with switch + cable  
Tischleuchte - ohne Lampenschirm - mit Schalter + Kabel

Materials  
aluminium  
brass

14  
13 | 23

Lamp type

◀ 1x D45 E27 max. 28W  -  230V

Base - L170xB170xH12

Colour	999B.250/..	999B.300/..	999B.400/..
	H 1000	H 250	H 300
13.2			
14.11			
23			
23.2			

built-up  
socle black or grey - other lengths on demand  
MAX.40W - Sockel Schwarz oder Grau - andere Längen auf Anfrage

990B/./.. - VOGUE

~230V  IP20    0,5 m  



table lamp - without lampshade - with switch + cable  
Tischleuchte - ohne Lampenschirm - mit Schalter + Kabel

Materials  
aluminium

14

Lamp type

◀ 1x D45 E27 max. 28W  -  230V

Base - L300xB110xH10

Colour	990B.250/..	990B.300/..	990B.400/..	990X/..
	H 250	H 300	H 400	H 0
14				

built-up  
other lengths on demand  
MAX.40W - andere Längen auf Anfrage







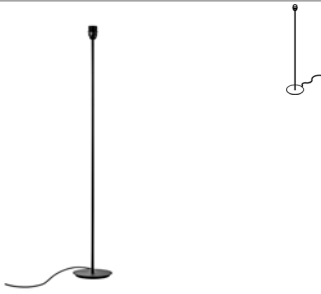

1482.1000/.. - VOGUE

~230V  IP20    0.5 m  05.20.02 



built-up

floorlamp - without lampshade - with switch + cable  
Stehleuchte - ohne Lampenschirm - mit Schalter + Kabel

<b>Lamp type</b>	1x D45 E27 max. 15W 	230V
<b>Dimensions</b>	Ø170xH12 - Bar 1000	
<b>Materials</b>	aluminium	1M   2M
	brass	23

<b>Ref</b>	1482.1000.1M	white tex
	1482.1000.2M	black tex
	1482.1000.23	dark bronze

5060/.. - VOGUE XL

~230V  IP20    0.5 m  05.20.02 

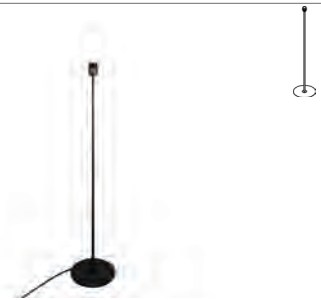

built-up

floorlamp - fixed - without lampshade - with switch + cable  
Stehleuchte - fest - ohne Lampenschirm - mit Schalter + Kabel

<b>Lamp type</b>	1x A60 E27 max. 40W 	230V
<b>Dimensions</b>	Ø320xH1200 - Bar 1200	
<b>Materials</b>	aluminium	1M   2M   46

<b>Ref</b>	5060.1M	white tex
	5060.2M	black tex
	5060.46	grey-brown



5062/.. - VOGUE XL

~230V  IP20    7.3500  0.5 m  05.20.02 



built-up

floorlamp - fixed - with switch + cable - with E27 socket  
Stehleuchte - fest - mit Schalter + Kabel - mit E27 Fassung

<b>Lamp type</b>	1x A60 E27 max. 40W 	230V
	or 1x G125 E27 max. 60W 	240V
<b>Dimensions</b>	Ø320xH1450 - Bar 1350	
<b>Materials</b>	aluminium	1M   2M   46

<b>Ref</b>	5062.1M	white tex
	5062.2M	black tex
	5062.46	grey-brown

5028/.. - VOGUE XL

~230V  IP20    0.5 m  05.20.02 

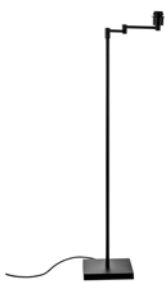

built-up

floorlamp - fixed - adjustable arm - without lampshade - with switch + cord  
Stehleuchte - fest - verstellbarer Arm - ohne Lampenschirm - mit Schalter + Schnur

<b>Lamp type</b>	1x A60 E27 max. 40W 	230V
<b>Dimensions</b>	Ø320xH1120 - Bar 1000	
<b>Materials</b>	aluminium	1M   2M   46
	brass	86

<b>Ref</b>	5028.1M	white tex
	5028.2M	black tex
	5028.86	flame bronze
	5028.46	grey-brown

5076/.. - POLINA

~230V



table lamp - fixed - with cable and plug  
Tischleuchte - fest - mit Kabel und Stecker

Lamp type

1x A60 E27 max. 60W A - E 230V

1x ST64 E27 max. 60W A - E 230V

Dimensions

Ø145xH265

Glass - Ø125xH250

Materials

INOX 32X | 46X | 53X | 63X | 64X | 31MX | 33MX

Ref

5076.31MX	white texture
5076.32X	black texture
5076.33MX	brown texture
5076.46X	grey-brown
5076.53X	bronze-brown
5076.63X	umbra grey
5076.64X	black grey

built-up

5077/.. - POLINA

~230V



table lamp - fixed - with cable and plug  
Tischleuchte - fest - mit Kabel und Stecker

Lamp type

1x A60 E27 max. 60W A - E 230V

1x ST64 E27 max. 60W A - E 230V

Dimensions

Ø160xH570 - Bar 300

Glass - Ø125xH250

Materials

INOX 32X | 46X | 53X | 63X | 64X | 31MX | 33MX

Ref

5077.31MX	white texture
5077.32X	black texture
5077.33MX	brown texture
5077.46X	grey-brown
5077.53X	bronze-brown
5077.63X	umbra grey
5077.64X	black grey

built-up





1485/.. - BOOSTER

~230V    IP20    0,5 m  05.20.50 



floorlamp - round - fixed - up - with cable and plug - with LED driver  
 Stehleuchte - rund - fest - up - mit Kabel und Stecker - mit Driver LED

Lamp type

 1x Led 3000lm CRI80 max. 25,6W  -  1050mA

Dimensions

 Ø165xH385

Materials







aluminium 1M | 2M

Ref

1485.1M.NW	white tex
1485.1M.WW	white tex
1485.2M.NW	black tex
1485.2M.WW	black tex

built-up



1486/.. - BOOSTER

~230V    IP20    0,5 m  05.20.50 



floorlamp - square - fixed - up - with cable and plug - with LED driver  
 Stehleuchte - viereckig - fest - up - mit Kabel und Stecker - mit Driver LED

Lamp type

 1x Led 3000lm CRI80 max. 25,6W  -  1050mA

Dimensions

 L150xB150xH385

Materials

aluminium 1M | 2M

Ref

1486.1M.NW	white tex
1486.1M.WW	white tex
1486.2M.NW	black tex
1486.2M.WW	black tex

built-up



1226/.. - HANGOVER

~230V  IP20    0,5 m  05.20.02 



floorlamp - fixed - with cable and plug  
 Stehleuchte - fest - mit Kabel und Stecker

Lamp type

 1x A60 E27 max. 15W  -  230V

Dimensions

 L2250xB500xH2300

Base - Ø300

Dome - Ø500xH250

Materials

aluminium 1M | 29 | 2M

Ref cat (LONG)

1226.1M	white tex
1226.2M	black tex
1226.1M.DK90	white tex
1226.2M.DK90	black tex
1226.29	black - gold in

built-up







W792/.. - POLO

~230V IP44 0,5 m 05.20.02



table lamp - with cable and plug  
Tischleuchte - mit Kabel und Stecker

**Lamp type**  
1x A60 E27 max. 40W **A** - **E** 230V

**Dimensions**  
L136xB136xH210  
Housing - L136xB136xH180  
Base - L120xB120xH30

**Materials**  
INOX 32X | 46X | 53X | 63X | 64X | 31MX | 33MX  
INOX 316 5 | 5BB

**Ref**  
W792.5 inox 316  
W792.5BB inox 316 2x coated  
W792.31MX white texture  
W792.32X black texture  
W792.33MX brown texture  
W792.46X grey-brown  
W792.53X bronze-brown  
W792.63X umbra grey  
W792.64X black grey

built-up  
designed for terraces  
speziell für Terrassen

W797/.. - POLO

~230V IP44 2,3900 0,5 m 05.20.02



floorlamp  
Stehleuchte

**Lamp type**  
1x A60 E27 max. 40W **A** - **E** 230V

**Dimensions**  
L136xB136xH210  
Housing - L136xB136xH180  
Base - L120xB120xH30

**Materials**  
INOX 32X | 46X | 53X | 63X | 64X | 31MX | 33MX  
INOX 316 5 | 5BB

**Ref**  
W797.5 inox 316  
W797.5BB inox 316 2x coated  
W797.31MX white texture  
W797.32X black texture  
W797.33MX brown texture  
W797.46X grey-brown  
W797.53X bronze-brown  
W797.63X umbra grey  
W797.64X black grey

built-up  
to be mounted on a pole or wall  
für Befestigung an Pfahl oder Wand

W792B/.. - POLO

~230V IP44 2,8700 0,5 m 05.20.02



table lamp - with cable and plug  
Tischleuchte - mit Kabel und Stecker

**Lamp type**  
1x A60 E27 max. 40W **A** - **E** 230V

**Dimensions**  
L136xB136xH280  
Housing - L136xB136xH250  
Base - L120xB120xH30

**Materials**  
INOX 32X | 46X | 53X | 63X | 64X | 31MX | 33MX  
INOX 316 5 | 5BB

**Ref**  
W792B.5 inox 316  
W792B.5BB inox 316 2x coated  
W792B.31MX white texture  
W792B.32X black texture  
W792B.33MX brown texture  
W792B.46X grey-brown  
W792B.53X bronze-brown  
W792B.63X umbra grey  
W792B.64X black grey

built-up  
designed for terraces  
speziell für Terrassen

W797B/.. - POLO

~230V IP44 2,9600 0,5 m 05.20.02



floorlamp  
Stehleuchte

**Lamp type**  
1x A60 E27 max. 40W **A** - **E** 230V

**Dimensions**  
L136xB136xH280  
Housing - L136xB136xH250  
Base - L120xB120xH30

**Materials**  
INOX 32X | 46X | 53X | 63X | 64X | 31MX | 33MX  
INOX 316 5 | 5BB

**Ref**  
W797B.5 inox 316  
W797B.5BB inox 316 2x coated  
W797B.31MX white texture  
W797B.32X black texture  
W797B.33MX brown texture  
W797B.46X grey-brown  
W797B.53X bronze-brown  
W797B.63X umbra grey  
W797B.64X black grey

built-up  
to be mounted on a pole or wall  
für Befestigung an Pfahl oder Wand



**W761/.. - POLO**

~230V  IP44    4,9300 0,5 m 05.20.02 



table lamp - with cable and plug  
Tischleuchte - mit Kabel und Stecker

**Lamp type**

◀ 1x A60 E27 max. 40W  230V

**Dimensions**

↔ L200xB200xH230

Housing - L200xB200xH200

Base - L145xB145xH30

**Materials**

INOX 32X | 46X | 53X | 63X | 64X | 31MX | 33MX  
INOX 316 5 | 5BB

**Ref**

W761.5	inox 316
W761.5BB	inox 316 2x coated
W761.31MX	white texture
W761.32X	black texture
W761.33MX	brown texture
W761.46X	grey-brown
W761.53X	bronze-brown
W761.63X	umbra grey
W761.64X	black grey



built-up  
designed for terraces  
speziell für Terrassen

**W764/.. - POLO**

~230V  IP44    4,1450 0,5 m 05.20.02 



floorlamp  
Stehleuchte

**Lamp type**

◀ 1x A60 E27 max. 40W  230V

**Dimensions**

↔ L200xB200xH230

Base - L145xB145xH30

Housing - L200xB200xH200

**Materials**

INOX 32X | 46X | 53X | 63X | 64X | 31MX | 33MX  
INOX 316 5 | 5BB

**Ref**

W764.5	inox 316
W764.5BB	inox 316 2x coated
W764.31MX	white texture
W764.32X	black texture
W764.33MX	brown texture
W764.46X	grey-brown
W764.53X	bronze-brown
W764.63X	umbra grey
W764.64X	black grey



built-up  
to be mounted on a pole or wall  
für Befestigung an Pfahl oder Wand  
especially for driveways  
speziell für Auffahrten

**W762/.. - POLO**





~230V  IP44    0,5 m 05.20.02 



table lamp - with cable and plug  
Tischleuchte - mit Kabel und Stecker

**Lamp type**

◀ 1x A60 E27 max. 60W  230V

**Dimensions**

↔ L200xB200xH280

Housing - L200xB200xH250

Base - L145xB145xH30

**Materials**

INOX 32X | 46X | 53X | 63X | 64X | 31MX | 33MX  
INOX 316 5 | 5BB

**Ref**

W762.5	inox 316
W762.5BB	inox 316 2x coated
W762.31MX	white texture
W762.32X	black texture
W762.33MX	brown texture
W762.46X	grey-brown
W762.53X	bronze-brown
W762.63X	umbra grey
W762.64X	black grey



built-up  
designed for terraces  
speziell für Terrassen

**W765/.. - POLO**

~230V  IP44    4,7050 0,5 m 05.20.02 



floorlamp  
Stehleuchte

**Lamp type**

◀ 1x A60 E27 max. 60W  230V

**Dimensions**

↔ L200xB200xH280

Base - L145xB145xH30

Housing - L200xB200xH250

**Materials**

INOX 32X | 46X | 53X | 63X | 64X | 31MX | 33MX  
INOX 316 5 | 5BB

**Ref**

W765.5	inox 316
W765.5BB	inox 316 2x coated
W765.31MX	white texture
W765.32X	black texture
W765.33MX	brown texture
W765.46X	grey-brown
W765.53X	bronze-brown
W765.63X	umbra grey
W765.64X	black grey



built-up  
to be mounted on a pole or wall  
für Befestigung an Pfahl oder Wand  
designed for driveways  
speziell für Auffahrten



W793/.. - POLO

~230V IP44 4,5400 0,5 m 05.20.02 CE



table lamp - with cable and plug  
Tischleuchte - mit Kabel und Stecker

Lamp type

1x A60 E27 max. 40W **A** - **E** 230V

Dimensions

L136xB136xH510

Housing - L136xB136xH480

Base - L120xB120xH30

Materials

INOX 32X | 46X | 53X | 63X | 64X | 31MX | 33MX  
INOX 316 5 | 5BB

Ref

W793.5	inox 316
W793.5BB	inox 316 2x coated
W793.31MX	white texture
W793.32X	black texture
W793.33MX	brown texture
W793.46X	grey-brown
W793.53X	bronze-brown
W793.63X	umbra grey
W793.64X	black grey

built-up  
designed for terraces  
speziell für Terrassen

W798/.. - POLO

~230V IP44 11,9500 0,5 m 05.20.02 CE



floorlamp  
Stehleuchte

Lamp type

1x A60 E27 max. 40W **A** - **E** 230V

Dimensions

L136xB136xH510

Housing - L136xB136xH480

Base - L120xB120xH30

Materials

INOX 32X | 46X | 53X | 63X | 64X | 31MX | 33MX  
INOX 316 5 | 5BB

Ref

W798.5	inox 316
W798.5BB	inox 316 2x coated
W798.31MX	white texture
W798.32X	black texture
W798.33MX	brown texture
W798.46X	grey-brown
W798.53X	bronze-brown
W798.63X	umbra grey
W798.64X	black grey

built-up  
to be mounted on a pole or wall  
für Befestigung an Pfahl oder Wand

W763/.. - POLO

~230V IP44 11,9500 0,5 m 05.20.02 CE



table lamp - with cable and plug  
Tischleuchte - mit Kabel und Stecker

Lamp type

1x A60 E27 max. 60W **A** - **E** 230V

Dimensions

L300xB300xH480

Housing - L300xB300xH450

Base - L245xB245xH30

Materials

INOX 32X | 46X | 53X | 63X | 64X | 31MX | 33MX  
INOX 316 5 | 5BB

Ref

W763.5	inox 316
W763.5BB	inox 316 2x coated
W763.31MX	white texture
W763.32X	black texture
W763.33MX	brown texture
W763.46X	grey-brown
W763.53X	bronze-brown
W763.63X	umbra grey
W763.64X	black grey

built-up  
designed for terraces  
speziell für Terrassen



978T/.. - CUBIC



~230V   IP20    0,7600 0,5 m 05.20.02 



table lamp - directional - with switch - cable and plug - with transformer  
Tischleuchte - schwenkbar - mit Schalter - Kabel und Stecker  
- mit Trafo

**Ref**  
978T.14 alu satin

**Lamp type**

 1x QR-CB 51 GU5,3/GX5,3 max. 50W  12V

**Dimensions**

 L60xB60xH180

**Materials**

aluminium 14

built-up

60VA

1741/.. - BETAPLUS



~230V   IP20    1,4450 0,5 m 05.20.02 



table lamp - directional - with switch - cable and plug - with transformer  
Tischleuchte - schwenkbar - mit Schalter - Kabel und Stecker  
- mit Trafo

**Ref**  
1741.1M white tex  
1741.2M black tex  
1741.11M grey tex

**Lamp type**

 1x QR-CB 51 GU5,3/GX5,3 max. 50W  12V

**Dimensions**

 L90xB90xH145

**Materials**

aluminium 1M | 2M | 11M

built-up

60VA

3020/.. - ORKA TABLE



~230V   IP20    1,1370 0,5 m 05.20.50 





table lamp - directional - with switch - cable and plug - with LED driver  
Tischleuchte - schwenkbar - mit Schalter - Kabel und Stecker  
- mit Driver LED

**Ref**  
3020.10.CW alu grey  
3020.10.WW alu grey  
3020.14.CW alu satin  
3020.14.WW alu satin  
3020.23.CW dark bronze  
3020.23.WW dark bronze

**Lamp type**

 1x powered 700mA max. 3W  700mA

**Dimensions**

 L110xB80xH40  40° reflector

Base - L90xB65

**Materials**

aluminium 10 | 14  
brass 23

built-up

other °angle reflector on demand  
andere °Winkel Reflektor auf Anfrage

1958.ES50/.. - VOLTA

~230V



table lamp - directional - with switch - cable and plug  
Tischleuchte - schwenkbar - mit Schalter - Kabel und Stecker

**Lamp type**

1x QPAR70 GU10 max. 7W A+ 230V

**Dimensions**

L100xB80xH150  
Base - L100xB80xH42

**Materials**

aluminium 14 | 1M | 2M  
brass 13 | 23

**Ref**

1958.ES50.1M	white tex
1958.ES50.2M	black tex
1958.ES50.13	bronze
1958.ES50.14	alu satin
1958.ES50.23	dark bronze

built-up

60VA

1958/.. - VOLTA

~230V



table lamp - directional - with switch - cable and plug - with transformer  
Tischleuchte - schwenkbar - mit Schalter - Kabel und Stecker - mit Trafo

**Lamp type**

1x QR-LP70 BA15d max. 50W A+ - E 12V

**Dimensions**

L100xB80xH150  
Base - L100xB80xH42

**Materials**

aluminium 14 | 1M | 2M  
brass 13 | 23

**Ref**

1958.1M	white tex
1958.2M	black tex
1958.13	bronze
1958.14	alu satin
1958.23	dark bronze

built-up

60VA

4030/.. - MONTE CRISTO

~230V   IP20    6,9600  0,5 m  05.20.02 





floorlamp - directional - with switch - cable and plug - with transformer  
Stehleuchte - schwenkbar - mit Schalter - Kabel und Stecker  
- mit Trafo

Ref cat (LONG)

4030.14 alu satin

Lamp type

 6x QR-CB 51 GU5,3/GX5,3 max. 35W  12V

Dimensions

 L320xB270xH1800

Base - L350xB350

Materials

aluminium 14

built-up

3X105VA

4031/.. - MONTE CRISTO

~230V   IP20    7,2400  0,5 m  05.20.02 





floorlamp - directional - with switch - cable and plug - with transformer  
Stehleuchte - schwenkbar - mit Schalter - Kabel und Stecker  
- mit Trafo

Ref cat (LONG)

4031.14 alu satin

Lamp type

 6x QR-CB 51 GU5,3/GX5,3 max. 35W  12V

Dimensions

 L320xB270xH2100

Base - L350xB350

Materials

aluminium 14

built-up

3X105VA

4011/.. - OPERA

~230V   IP20    5,4000  1 m  05.20.02 



floorlamp - with switch - cable and plug - with transformer  
Stehleuchte - mit Schalter - Kabel und Stecker - mit Trafo

Ref

4011.1M white tex  
4011.2M black tex  
4011.14 alu satin

Lamp type

 4x QR-LP111 G53 max. 12W  12V  
or  4x PAR 36 screw max. 50W  12V

Dimensions

 L410xB364xH1010

Materials

aluminium 14 | 1M | 2M

built-up

4012/.. - OPERA

~230V   IP20    5,8500  1 m  05.20.02 



floorlamp - directional - with switch - cable and plug - with transformer  
Stehleuchte - schwenkbar - mit Schalter - Kabel und Stecker  
- mit Trafo

Ref

4012.1M white tex  
4012.2M black tex  
4012.14 alu satin

Lamp type

 4x QR-LP111 G53 max. 12W  12V  
or  4x PAR 36 screw max. 50W  12V

Dimensions

 L410xB364xH1310

Materials

aluminium 14 | 1M | 2M

built-up

1830/.. - GOTA

~230V



floorlamp - with switch - cable and plug - with electronic gear  
Stehleuchte - mit Schalter - Kabel und Stecker - mit elektronischem Vorschaltgerät

Ref

1830.14

alu satin

Lamp type

2x T16FH T5 G5 max. 21W **A+** - **D** 230V

Dimensions

Ø320xH1300

Materials

aluminium

14

built-up  
with alu base Ø250mm  
mit Alu Fuß Ø250mm

1831/.. - GOTA

~230V



floorlamp - with switch - cable and plug - with electronic gear  
Stehleuchte - mit Schalter - Kabel und Stecker - mit elektronischem Vorschaltgerät

Ref cat (LONG)

1831.14

alu satin

Lamp type

2x T16FH T5 G5 max. 21W **A+** - **D** 230V

Dimensions

Ø320xH1900

Materials

aluminium

14

built-up  
with alu base Ø350mm  
mit Alu Fuß

1832/.. - GOTA

~230V



floorlamp - with switch - cable and plug - with electronic gear  
Stehleuchte - mit Schalter - Kabel und Stecker - mit elektronischem Vorschaltgerät

Ref

1832.14

alu satin

Lamp type

2x T16FH T5 G5 max. 21W **A+** - **D** 230V

Dimensions

Ø320xH1460

Materials

aluminium

14

built-up  
with alu base Ø320mm  
mit Alu Fuß



# INDOOR DRIVERS

# Index

12V-AC	711
12V-DC	712
24V-DC	713-714
48V-DC	715
.....	
250mA	702
350mA	703-704
500mA	705-706
700mA	707-708
1050mA	709
1400mA	710
.....	
CASAMBI	716-719
TRANSFOKAST	720-721
KABELGOOT	722-726

## 250mA



<b>LED DRIVER</b>	250mA	250mA	250mA	250mA	250mA
<b>CODE</b>	TR127048/..	TR28002402/..	TR123403/..	TR127556/..	TR123424/..
<b>DIMENSIONS (LxWxH (mm))</b>	L102xB38xH21	Ø42xH20	L111xB52xH22	L110xB52xH22	L103xB67xH21
<b>INPUT</b>	230V 50Hz	230V 50Hz	230V 50Hz	230V 50Hz	230V 50Hz
<b>OUTPUT VOLTAGE</b>	18-28V	21-40V	15-43V	15-48V	10-48V
<b>OUTPUT POWER</b>	7.00W	10.00W	10.00W	12.00W	12.00W
<b>MAX POWER FACTOR</b>	0,96	0,90	0,92	0,85	0,95
<b>DIMMING</b>					
<b>PRICE</b>	€27,95	€18,48	€50,35	€44,52	€49,70

## 250mA



<b>LED DRIVER</b>	250mA
<b>CODE</b>	TR123680/..
<b>DIMENSIONS (LxWxH (mm))</b>	L124xB79xH22
<b>INPUT</b>	230V 50Hz
<b>OUTPUT VOLTAGE</b>	2-53V
<b>OUTPUT POWER</b>	13.00W
<b>MAX POWER FACTOR</b>	0,96
<b>DIMMING</b>	
<b>PRICE</b>	€59,15

## 350mA



LED DRIVER	350mA	350mA	350mA	350mA	350mA
CODE	VLMPTDCC3.350MA/..	RSD35005E/..	LTLED6CC.350mA/..	OT9D.350MA/..	TR127040/..
	IP20	IP20	IP20	IP20	IP20
DIMENSIONS (LxWxH (mm))	L40xB42xH21	Ø53xH22	L45xB45xH25	L108xB53xH33	L102xB38xH21,2
INPUT	230V 50Hz	230V 50Hz	230V 50Hz	230V 50Hz	230V 50Hz
OUTPUT VOLTAGE	8,5V	8-14V	2-17V	10-26V	8,5-28V
OUTPUT POWER	3.00W	5.00W	6.00W	9.00W	10.00W
MAX POWER FACTOR	0,86	0,95	0,90	0,90	0,96
DIMMING					
PRICE	€23,28	€25,00	€35,26	€43,74	€27,95

## 350mA



LED DRIVER	350mA	350mA	350mA	350mA	350mA
CODE	TR122790/..	TR28002403/..	TR87500386/..	TR123400/..	TR123403/..
	IP20	IP20	IP20	IP20	IP20
DIMENSIONS (LxWxH (mm))	L66xB50xH22	Ø42xH20	L102xB51xH30	L111xB52xH22	L111xB52xH22
INPUT	230V 50Hz	230V 50Hz	230V 50Hz	230V 50Hz	230V 50Hz
OUTPUT VOLTAGE	2-31V	21-40V	21-42V	2-43V	2-43V
OUTPUT POWER	12.00W	14.00W	15.00W	15.00W	15.00W
MAX POWER FACTOR	0,54	0,90	0,97	0,95	0,92
DIMMING					
PRICE	€32,24	€18,90	€24,75	€40,57	€50,35

## 350mA



LED DRIVER	350mA	350mA	350mA	350mA	350mA
CODE	TR89800255/..	TR122246/..	TR122200/..	TR122260/..	VLMPTDCC15.350MA/..
	IP20	IP20	IP20	IP20	IP20
DIMENSIONS (LxWxH (mm))	L139xB30xH21	L122xB38xH28	L103xB67xH21	L166xB46xH34	L124xB40xH20
INPUT	230V 50Hz	230V 50Hz	230V 50Hz	230V 50Hz	230V 50Hz
OUTPUT VOLTAGE	21-46V	3-47V	2-47V	2-47V	48V
OUTPUT POWER	15.00W	17.00W	17.00W	17.00W	17.00W
MAX POWER FACTOR	0,97	0,55	0,98	0,97	0,60
DIMMING					
PRICE	€25,50	€31,15	€48,90	€64,84	€32,40



## 350mA



<b>LED DRIVER</b>	350mA	350mA	350mA	350mA	350mA
<b>CODE</b>	TR123424/..	TR127556/..	TR123680/..	TRLCM25/..	TR127630/..
<b>DIMENSIONS (LxWxH (mm))</b>	L103xB67xH21	L110xB52xH22	L124xB79xH22	L105xB68xH23	L124xB79xH22
<b>INPUT</b>	230V 50Hz	230V 50Hz	230V 50Hz	230V 50Hz	230V 50Hz
<b>OUTPUT VOLTAGE</b>	5-48V	10-48V	2-53V	6-54V	10-54V
<b>OUTPUT POWER</b>	17.00W	17.00W	18.00W	18.00W	18.50W
<b>MAX POWER FACTOR</b>	0,95	0,85	0,96	0,94	0,95
<b>DIMMING</b>					
<b>PRICE</b>	€49,70	€44,52	€59,15	€62,99	€97,65

## 350mA



<b>LED DRIVER</b>	350mA	350mA	350mA	350mA	350mA
<b>CODE</b>	LPC20-350/..	TR122204/..	TR127411/..	TR127413/..	TRLCM40/..
<b>DIMENSIONS (LxWxH (mm))</b>	L118xB35xH26	L124xB79xH22	L124xB79xH22	L124xB79xH22	L123,5xB81,5xH23
<b>INPUT</b>	230V 50Hz	230V 50Hz	230V 50Hz	230V 50Hz	230V 50Hz
<b>OUTPUT VOLTAGE</b>	9-48V	2-72V	2-74V	2-74V	2-100V
<b>OUTPUT POWER</b>	20.00W	25.00W	25.00W	25.00W	40.00W
<b>MAX POWER FACTOR</b>	0,83	0,95	0,95	0,95	0,91
<b>DIMMING</b>					
<b>PRICE</b>	€20,19	€64,84	€93,82	€91,08	€60,20

## 500mA



LED DRIVER	500mA	500mA	500mA	500mA	500mA
CODE	RSD50007E/..	TR127042/..	TR122794/..	TR87500320/..	TR89800256/..
DIMENSIONS (LxWxH (mm))	Ø53xH22	L102xB38xH21	L66xB50xH22	L102xB51xH30	L139xB30xH21
INPUT	230V 50Hz	230V 50Hz	230V 50Hz	230V 50Hz	230V 50Hz
OUTPUT VOLTAGE	8-14V	6-20V	2-24V	13,5-30V	13,5-30V
OUTPUT POWER	7.00W	10.00W	12.00W	15.00W	15.00W
MAX POWER FACTOR	0,90	0,96	0,54	0,97	0,97
DIMMING					
PRICE	€27,00	€27,95	€32,24	€24,75	€25,50

## 500mA



LED DRIVER	500mA	500mA	500mA	500mA	500mA
CODE	TR122248/..	TR123403/..	TR123400/..	TR127556/..	TR122200/..
DIMENSIONS (LxWxH (mm))	L122xB38xH28	L111xB52xH22	L111xB52xH22	L110xB52xH22	L103xB67xH21
INPUT	230V 50Hz	230V 50Hz	230V 50Hz	230V 50Hz	230V 50Hz
OUTPUT VOLTAGE	3-40V	2-40V	2-43V	5-40V	2-47V
OUTPUT POWER	20.00W	20.00W	20.00W	20.00W	24.00W
MAX POWER FACTOR	0,57	0,92	0,95	0,85	0,98
DIMMING					
PRICE	€36,95	€50,35	€40,57	€44,52	€48,90

## 500mA



LED DRIVER	500mA	500mA	500mA	500mA	500mA
CODE	TR122260/..	TR123424/..	TRLCM25/..	TR123680/..	TR127630/..
DIMENSIONS (LxWxH (mm))	L166xB46xH34	L103xB67xH21	L105xB68xH23	L124xB79xH22	L124xB79xH22
INPUT	230V 50Hz	230V 50Hz	230V 50Hz	230V 50Hz	230V 50Hz
OUTPUT VOLTAGE	2-47V	5-48V	6-50V	2-46V	10-54V
OUTPUT POWER	24.00W	24.00W	25.00W	26.00W	27.00W
MAX POWER FACTOR	0,97	0,95	0,94	0,96	0,95
DIMMING					
PRICE	€64,84	€49,70	€62,99	€59,15	€97,65

# 500mA



<b>LED DRIVER</b>	500mA	500mA	500mA	500mA
<b>CODE</b>	TR122204/..	TR127411/..	TR127413/..	TRLCM40/..
<b>DIMENSIONS (LxWxH (mm))</b>	L124x879xH22	L124x879xH22	L124x879xH22	L123,5x881,5xH23
<b>INPUT</b>	230V 50Hz	230V 50Hz	230V 50Hz	230V 50Hz
<b>OUTPUT VOLTAGE</b>	2-72V	2,72V	2-72V	2-80V
<b>OUTPUT POWER</b>	35.00W	35.00W	35.00W	40.00W
<b>MAX POWER FACTOR</b>	0,95	0,95	0,95	0,91
<b>DIMMING</b>				
<b>PRICE</b>	€64,84	€93,82	€91,08	€60,20

## 700mA



LED DRIVER	700mA	700mA	700mA	700mA	700mA
CODE	LTLED6CC.700MA/..	TR127046/..	TR122792/..	TR87500387/..	TR89800257/..
DIMENSIONS (LxWxH (mm))	L45xB45xH25	L102xB38xH21	L66xB50xH22	L102xB51xH30	L139xB30xH21
INPUT	230V 50Hz	230V 50Hz	230V 50Hz	230V 50Hz	230V 50Hz
OUTPUT VOLTAGE	2-9V	3-14V	2-16V	10-20V	10-21,5V
OUTPUT POWER	6.00W	10.00W	12.00W	14.00W	15.00W
MAX POWER FACTOR	0,90	0,96	0,54	0,97	0,97
DIMMING					
PRICE	€37,50	€27,95	€32,24	€24,75	€25,50

## 700mA



LED DRIVER	700mA	700mA	700mA	700mA	700mA
CODE	TR122234/..	VLMPTDCC15.700B/..	OT18D.700MA/..	RN1408/..	TR123403/..
DIMENSIONS (LxWxH (mm))	L122xB38xH28	L124xB38xH20	L108xB53xH33	L133xB44xH28	L111xB52xH22
INPUT	230V 50Hz	230V 50Hz	230V 50Hz	230V 50Hz	230V 50Hz
OUTPUT VOLTAGE	2-24V	24V	2-25V	6-26V	2-28V
OUTPUT POWER	17.00W	17.00W	18.00W	18.00W	20.00W
MAX POWER FACTOR	0,60	0,90	0,52	0,90	0,92
DIMMING					
PRICE	€36,95	€32,40	€70,37	€43,83	€50,35

## 700mA



LED DRIVER	700mA	700mA	700mA	700mA	700mA
CODE	TR123400/..	TR127556/..	LPC20-700/..	TRLCM25/..	TR122200/..
DIMENSIONS (LxWxH (mm))	L111xB52xH22	L110xB52xH22	L118xB35xH26	L105xB68xH23	L103xB67xH21
INPUT	230V 50Hz	230V 50Hz	230V 50Hz	230V 50Hz	230V 50Hz
OUTPUT VOLTAGE	2-29V	5-29V	9-30V	6-36V	2-46V
OUTPUT POWER	20.00W	20.00W	20.00W	25.00W	32.00W
MAX POWER FACTOR	0,95	0,85	0,83	0,94	0,98
DIMMING					
PRICE	€40,57	€44,52	€20,19	€62,99	€48,90



## 700mA



<b>LED DRIVER</b>	700mA	700mA	700mA	700mA	700mA
<b>CODE</b>	TR122260/..	TR123424/..	TR123680/..	OT35.700MA/..	LPC35-700/..
<b>DIMENSIONS (LxWxH (mm))</b>	L166xB46xH34	L103xB67xH21	L124xB79xH22	L123xB79xH33	L148xB40xH30
<b>INPUT</b>	230V 50Hz	230V 50Hz	230V 50Hz	230V 50Hz	230V 50Hz
<b>OUTPUT VOLTAGE</b>	2-46V	3-46V	2-46V	24-50V	9-48V
<b>OUTPUT POWER</b>	32.00W	32.00W	32.00W	35.00W	35.00W
<b>MAX POWER FACTOR</b>	0,97	0,95	0,96	0,95	0,85
<b>DIMMING</b>					
<b>PRICE</b>	€64,84	€49,70	€59,15	€157,09	€29,05

## 700mA



<b>LED DRIVER</b>	700mA	700mA	700mA	700mA	700mA
<b>CODE</b>	TR127630/..	TRLCM40/..	TR122204/..	TR127411/..	TR127413/..
<b>DIMENSIONS (LxWxH (mm))</b>	L124xB79xH22	L123,5xB81,5xH23	L124xB79xH22	L124xB79xH22	L124xB79xH22
<b>INPUT</b>	230V 50Hz	230V 50Hz	230V 50Hz	230V 50Hz	230V 50Hz
<b>OUTPUT VOLTAGE</b>	10-20V	2-57V	2-71V	2,72V	2-72V
<b>OUTPUT POWER</b>	36.00W	40.00W	50.00W	50.00W	50.00W
<b>MAX POWER FACTOR</b>	0,95	0,91	0,95	0,95	0,95
<b>DIMMING</b>					
<b>PRICE</b>	€97,65	€60,20	€64,84	€93,82	€91,08

## 1050mA



<b>LED DRIVER</b>	1050mA	1050mA	1050mA	1050mA	1050mA
<b>CODE</b>	CLK20.1050P/..	TRLCM25/..	TR122236/..	TRLCM40/..	TR127630/..
<b>DIMENSIONS (LxWxH (mm))</b>	L141xB43xH30	L105xB68xH23	L122xB38xH28	L123,5xB81,5xH23	L124xB79xH22
<b>INPUT</b>	230V 50Hz	230V 50Hz	230V 50Hz	230V 50Hz	230V 50Hz
<b>OUTPUT VOLTAGE</b>	10-19V	6-24V	2-21V	2-40V	10-36V
<b>OUTPUT POWER</b>	20.00W	25.00W	22.00W	40.00W	38.00W
<b>MAX POWER FACTOR</b>	0,95	0,94	0,60	0,91	0,95
<b>DIMMING</b>					
<b>PRICE</b>	€64,45	€62,99	€40,57	€60,20	€97,65

## 1050mA



<b>LED DRIVER</b>	1050mA	1050mA	1050mA	1050mA	1050mA
<b>CODE</b>	TR122204/..	TR127413/..	TR127310/..	TR127552/..	TR127411/..
<b>DIMENSIONS (LxWxH (mm))</b>	L124xB79xH22	L124xB79xH22	L130xB76xH30	L110xB76xH30	L124xB79xH22
<b>INPUT</b>	230V 50Hz	230V 50Hz	230V 50Hz	230V 50Hz	230V 50Hz
<b>OUTPUT VOLTAGE</b>	2-48V	2-57V	2-44V	2-43V	
<b>OUTPUT POWER</b>	50.00W	60.00W	45.00W	45.00W	60.00W
<b>MAX POWER FACTOR</b>	0,95	0,95	0,98	0,95	0,95
<b>DIMMING</b>					
<b>PRICE</b>	€64,84	€91,08	€70,64	€76,00	€93,82





# 1400mA



<b>LED DRIVER</b>	1400mA	1400mA	1400mA
<b>CODE</b>	TRPLM40-1400/..	TR127552/..	TR127310/..
<b>DIMENSIONS (LxWxH (mm))</b>	L175xB42xH24	L110xB76xH30	L130xB76xH30
<b>INPUT</b>	230V 50Hz	230V 50Hz	230V 50Hz
<b>OUTPUT VOLTAGE</b>	15-29V	2-36V	2-39V
<b>OUTPUT POWER</b>	40.60W	50.00W	55.00W
<b>MAX POWER FACTOR</b>	0,97	0,95	0,98
<b>DIMMING</b>			
<b>PRICE</b>	€42,09	€76,00	€70,64

## 12V-AC



<b>LED DRIVER</b>	12V-AC
<b>CODE</b>	TR119772/..
	   IP20
<b>DIMENSIONS (LxWxH (mm))</b>	L107xB32xH20
<b>INPUT</b>	230V 50Hz
<b>OUTPUT CURRENT</b>	
<b>OUTPUT POWER</b>	50.00W
<b>MAX POWER FACTOR</b>	0,98
<b>DIMMING</b>	
<b>PRICE</b>	€25,00



# 12V-DC



<b>LED DRIVER</b>	12V-DC	12V-DC	12V-DC	12V-DC	12V-DC
<b>CODE</b>	TR123400/..	TR123424/..	TR122260/..	TR127556/..	TR122200/..
<b>DIMENSIONS (LxWxH (mm))</b>	L111xB52xH22	L103xB67xH21	L166xB46xH34	L110xB52xH22	L103xB67xH21
<b>INPUT</b>	230V 50Hz	230V 50Hz	230V 50Hz	230V 50Hz	230V 50Hz
<b>OUTPUT CURRENT</b>	0,9A	0,9A	0,9A	0,9A	1,05A
<b>OUTPUT POWER</b>	10.00W	10.00W	10.00W	11.00W	13.00W
<b>MAX POWER FACTOR</b>	0,95	0,95	0,97	0,85	0,98
<b>DIMMING</b>					
<b>PRICE</b>	€40,57	€49,70	€64,84	€44,52	€48,90

## 24V-DC



LED DRIVER	24V-DC	24V-DC	24V-DC	24V-DC	24V-DC
CODE	GEARER14PU06/..	TR122434/..	TR122442/..	TR123403/..	TR123680/..
DIMENSIONS (LxWxH (mm))	L100xB48xH39	L194xB20xH20	L158xB22xH19	L111xB52xH22	L124xB79xH22
INPUT	230V 50Hz	230V 50Hz	230V 50Hz	230V 50Hz	230V 50Hz
OUTPUT CURRENT	12A	0,54A	0,54A	0,62A	0,7A
OUTPUT POWER	12.00W	13.00W	13.00W	15.00W	17.00W
MAX POWER FACTOR	0,90	0,60	0,60	0,92	0,96
DIMMING					
PRICE	€60,86	€35,14	€30,43	€50,35	€59,15

## 24V-DC



LED DRIVER	24V-DC	24V-DC	24V-DC	24V-DC	24V-DC
CODE	LPV2024/..	TR122200/..	TR123400/..	TR123424/..	TR122260/..
DIMENSIONS (LxWxH (mm))	L118xB35xH26	L103xB67xH21	L111xB52xH22	L103xB67xH21	L166xB46xH34
INPUT	230V 50Hz	230V 50Hz	230V 50Hz	230V 50Hz	230V 50Hz
OUTPUT CURRENT	0,83A	1,05A	0,9A	0,83A	0,9A
OUTPUT POWER	20.00W	20.00W	20.00W	20.00W	20.00W
MAX POWER FACTOR	0,90	0,98	0,95	0,95	0,97
DIMMING					
PRICE	€21,98	€48,90	€40,57	€49,70	€64,84

## 24V-DC



LED DRIVER	24V-DC	24V-DC	24V-DC	24V-DC	24V-DC
CODE	TR127556/..	LPV3524/..	TR127552/..	LPV6024/..	HDR60-24/..
DIMENSIONS (LxWxH (mm))	L110xB52xH22	L148xB40xH30	L110xB76xH30	L162xB42,5xH32	L52,5xB90xH54,5
INPUT	230V 50Hz	230V 50Hz	230V 50Hz	230V 50Hz	230V 50Hz
OUTPUT CURRENT	0,83A	1,45A	2,08A	2,5A	2,5A
OUTPUT POWER	20.00W	35.00W	50.00W	60.00W	60.00W
MAX POWER FACTOR	0,85	0,90	0,95	0,90	0,90
DIMMING					
PRICE	€44,52	€31,66	€76,00	€35,65	€43,75

## 24V-DC



<b>LED DRIVER</b>	24V-DC	24V-DC	24V-DC	24V-DC	24V-DC
<b>CODE</b>	LPV10024/..	HDR100-24N/..	LPV15024/..	HDR150-24/..	NDR240-24/..
	IP20	IP20	IP20	IP20	IP20
<b>DIMENSIONS (LxWxH (mm))</b>	L190xB52xH37	L70xB90xH54,5	L191xB63xH37,5	L105xB90xH54,5	L63xB125,2xH113,5
<b>INPUT</b>	230V 50Hz	230V 50Hz	230V 50Hz	230V 50Hz	230V 50Hz
<b>OUTPUT CURRENT</b>	4,2A	4,2A	6,25A	6,25A	10A
<b>OUTPUT POWER</b>	100.00W	100.00W	150.00W	150.00W	240.00W
<b>MAX POWER FACTOR</b>	0,90	0,90	0,90	0,90	0,98
<b>DIMMING</b>					
<b>PRICE</b>	€58,50	€61,25	€81,36	€78,05	€123,20







## 24V-DC



<b>LED DRIVER</b>	24V-DC
<b>CODE</b>	NDR480-24/..
	IP20
<b>DIMENSIONS (LxWxH (mm))</b>	L85,5xB125,2xH128,5
<b>INPUT</b>	230V 50Hz
<b>OUTPUT CURRENT</b>	20A
<b>OUTPUT POWER</b>	480.00W
<b>MAX POWER FACTOR</b>	0,98
<b>DIMMING</b>	
<b>PRICE</b>	€240,45

## 48V-DC



LED DRIVER	48V-DC	48V-DC	48V-DC	48V-DC	48V-DC
CODE	RSLP035-48/..	TR122204/..	TR127413/..	TR127310/..	LPV6048/..
	 	 	 	 	 
DIMENSIONS (LxWxH (mm))	L70xB52xH27	L124xB79xH22	L124xB79xH22	L130xB76xH30	L162xB42,5xH32
INPUT	230V 50Hz	230V 50Hz	230V 50Hz	230V 50Hz	230V 50Hz
OUTPUT CURRENT	0,72A	1,05A	10,5A	2,29A	1,25A
OUTPUT POWER	35,00W	50,00W	50,00W	55,00W	60,00W
MAX POWER FACTOR	0,90	0,95	0,95	0,98	0,86
DIMMING					
PRICE	€98,55	€64,84	€91,08	€70,64	€38,53



## 48V-DC



LED DRIVER	48V-DC	48V-DC	48V-DC	48V-DC	48V-DC
CODE	DRP12048/..	HDR150-48/..	DRP24048/..	NDR240-48/..	DRP48048/..
	 	 	 	 	 
DIMENSIONS (LxWxH (mm))	L125,2xB65,5xH100	L105xB90xH54,5	L125,5xB125xH100	L63xB125,2xH113,5	L227xB125,2xH100
INPUT	230V 50Hz	230V 50Hz	230V 50Hz	230V 50Hz	230V 50Hz
OUTPUT CURRENT	2,5A	3,2A	5A	5A	10A
OUTPUT POWER	120,00W	150,00W	240,00W	240,00W	480,00W
MAX POWER FACTOR	0,90	0,90	0,85	0,98	0,90
DIMMING					
PRICE	€97,55	€78,05	€161,13	€123,20	€231,48

## 48V-DC



LED DRIVER	48V-DC
CODE	NDR480-48/..
	 
DIMENSIONS (LxWxH (mm))	L85,5xB125,2xH128,5
INPUT	230V 50Hz
OUTPUT CURRENT	10A
OUTPUT POWER	480,00W
MAX POWER FACTOR	0,98
DIMMING	
PRICE	€240,45



# INDOOR CASAMBI

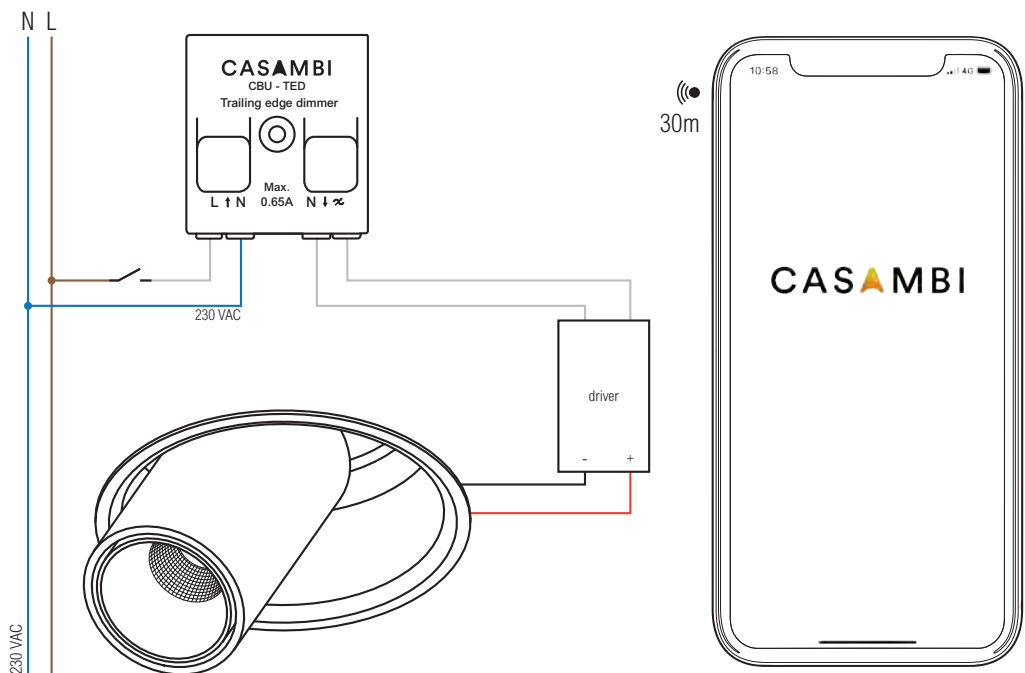

## CBU-TED/.. - CASAMBI

IP20  

Dimmer fase afsnijding geschikt voor gloeilampen en dimbare LED lampen  
Trailing edge dimmer for incandescent lamps or dimmable LED lamps

Ref  
CBU-TED

Price €  
88,00

**Dimensions**

↔ L40,4xB36,3xH14

## CBU-ASD/.. - CASAMBI

IP20  

Bluetooth controller voor 0-10V, 1-10V, Dali, Dali Tunable White, Dali RGB en RGBW  
Bluetooth controller for 0-10V, 1-10V, Dali, Dali Tunable White, Dali RGB and RGBW

Ref  
CBU-ASD

Price €  
100,00

**Dimensions**

↔ L56,5xB35,8xH22,3

## CBU-A2D/.. - CASAMBI

IP20  

Aansturing voor een of twee 0-10V bestuurbare LEDs of een tunable white LED met twee 0-10V-interfaces. Ook configureerbaar in een DALI-modus.  
Controller for one or two 0-10V LEDs or one tunable white LED with two 0-10V-interfaces. Also configurable in a DALI-modus.

Ref  
CBU-A2D

Price €  
153,00

**Dimensions**

↔ L76xB26xH23

**X-PRESS/.. - CASAMBI**

IP20   



Draadloze bluetooth schakelaar - naar wens programmeerbaar  
Wireless bluetooth interface - programmable at will

Ref	Price €
X-PRESS.1	221,00
X-PRESS.2	221,00

**Dimensions**

↔ L90xB90xH12

**Materials**

aluminium 1 | 2

**BLE-EWSSB/.. - CASAMBI**

IP20    09.20.07 



Kinetische schakelaar - programmeerbaar naar wens  
Kinetic switch - programmable at will

Ref	Price €
BLE-EWSSB	100,00

**Dimensions**

↔ L81xB81xH14

**BLE-EWSDB/.. - CASAMBI**

IP20  



Kinetische schakelaar - programmeerbaar naar wens  
Kinetic switch - programmable at will

Ref	Price €
BLE-EWSDB	100,00

**Dimensions**

↔ L81xB81xH14

SC-TI-CAS/.. - CASAMBI

IP20  



4 kanaals taster interface - draadloos  
Input module for up to 4 potential-free buttons - wireless

Ref  
SC-TI-CAS

Price €  
176,00

Dimensions  
↔ Ø53xH21

LD220WCM/.. - CASAMBI

 IP20  





Bluetooth dimmer met drukknop - geschikt voor LED lampen  
en LED dimmers  
Bluetooth dimmer with push button - appropriate for LED  
lamps en LED dimmers

Ref  
LD220WCM

Price €  
135,00

Dimensions  
↔ Ø56xH22

TR127630/.. - MULTI DRIVER push-CASAMBI

 IP20  

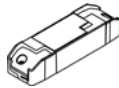

multi driver - DC JOLLY SLIM  
multi driver

Ref  
TR127630

Price €  
97,65

Dimensions  
↔ L124xB79xH22



# TRANSFOKAST PERFORÉ

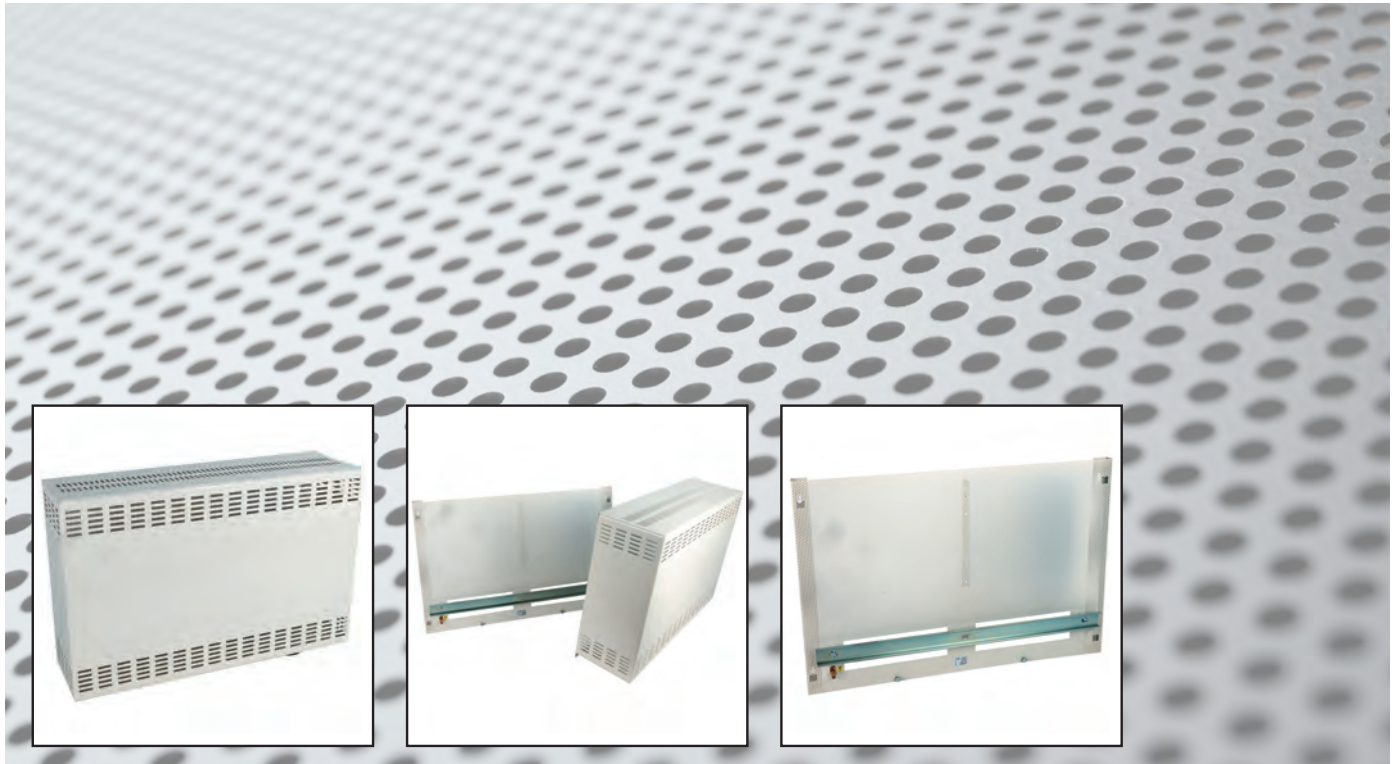

## TR20X/.. - NEW TRANSFOKAST PERFO

IP20 0,5000



transfokast - voor transfos of led drivers  
multiple transformer box - for transformers or led drivers

Ref cat (STD)  
TR20X

Price €  
101,43

**Dimensions**

L300xB200xD200

ral 9001 - bodem in perforé  
ral 9001 - punched fixation plate

## TR30X/.. - NEW TRANSFOKAST PERFO

IP20 6,2000



transfokast - voor transfos of led drivers  
multiple transformer box - for transformers or led drivers

Ref cat (STD)  
TR30X

Price €  
132,48

**Dimensions**

L400xB300xD200

ral 9001 - bodem in perforé  
ral 9001 - punched fixation plate

**TR40X/.. - NEW TRANSFOKAST PERFO**

IP20    9,5000 



transfokast - voor transfos of led drivers  
multiple transformer box - for transformers or led drivers

Ref cat (STD)  
TR40X

Price €  
173,88

**Dimensions**  
↔ L600xB400xD200

ral 9001 - bodem in perforé  
ral 9001 - punched fixation plate

**TR60X/.. - NEW TRANSFOKAST PERFO**

IP20   



transfokast - voor transfos of led drivers  
multiple transformer box - for transformers or led drivers

Ref cat (STD)  
TR60X

Price €  
267,03

**Dimensions**  
↔ L600xB600xD200

ral 9001 - bodem in perforé  
ral 9001 - punched fixation plate

**TR80X/.. - NEW TRANSFOKAST PERFO**

IP20    16,0000 



transfokast - voor transfos of led drivers  
multiple transformer box - for transformers or led drivers

Ref cat (STD)  
TR80X

Price €  
327,06

**Dimensions**  
↔ L800xB600xD200

in ral 9001 - bodem in perforé  
ral 9001 - punched fixation plate

psm.channel

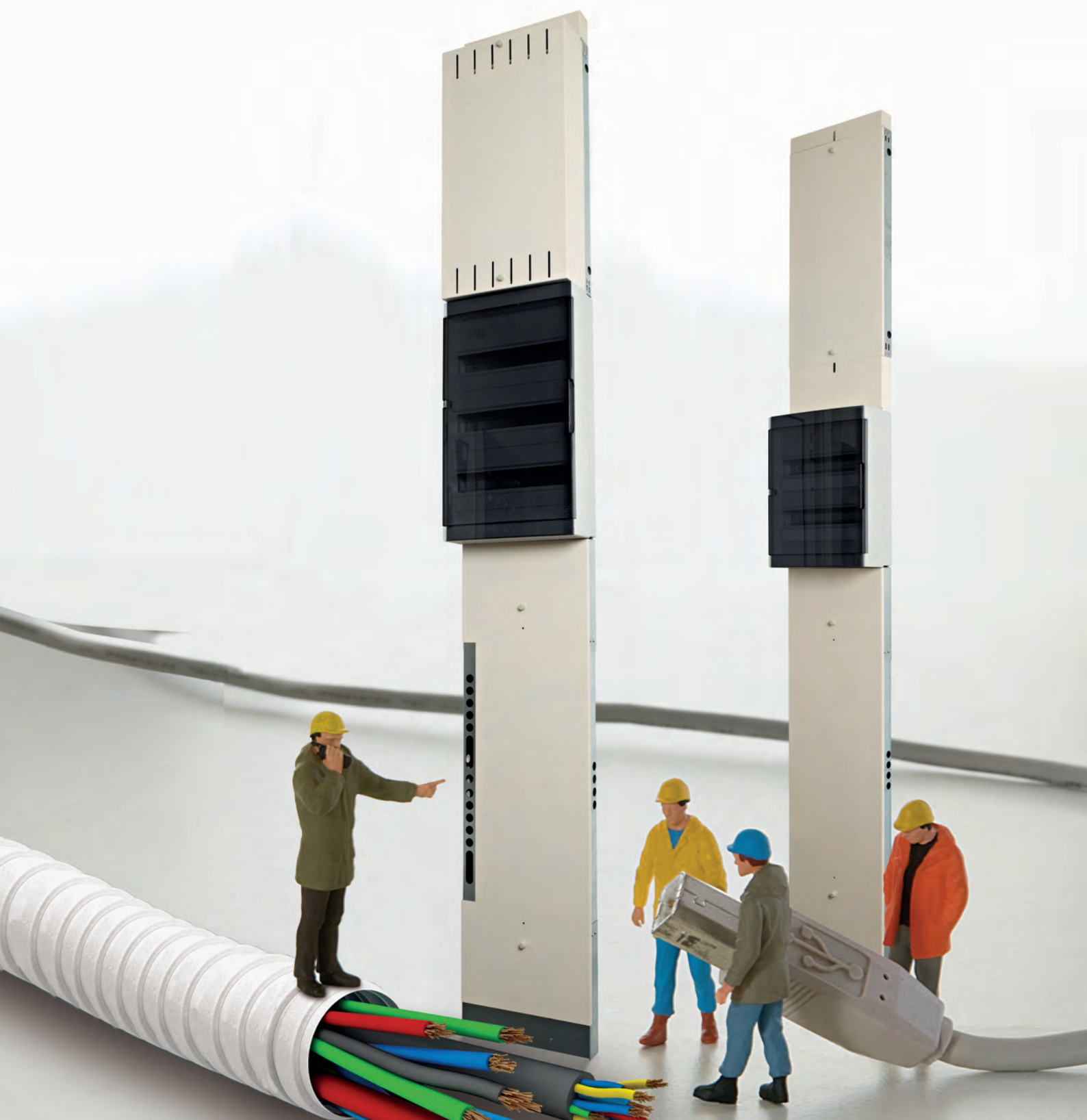

**KG01/.. - KABELGOOT TYPE I D54**

IP20    3,0000 



kabelgoot galvanisé - onder verdeelkast met ingangen zijkant  
 cable duct galvanised - under distribution box with cable entries on the side

Ref		Price €
KG01.11MG	grey tex	115,69
KG01.RAL 9001	Cream	128,34

**Dimensions**  
 L1200xB340xD54

**Materials**  
 aluminium RAL 9001  
 galvanized 11MG

*built-up*  
 frontplaat galvanisé of gelakt RAL9001  
 cover plate galvanised or varnished RAL9001

**KG02/.. - KABELGOOT TYPE II D54**

IP20   



kabelgoot galvanisé - onder verdeelkast met ingangen op frontplaat  
 cable duct galvanised - under distribution box with entries on cover plate

Ref		Price €
KG02.11MG	grey tex	115,92
KG02.RAL 9001	Cream	132,48

**Dimensions**  
 L1200xB340xD54

**Materials**  
 aluminium RAL 9001  
 galvanized 11MG

*built-up*  
 frontplaat galvanisé of gelakt RAL9001  
 cover plate galvanised or varnished RAL9001

**KG03/.. - KABELGOOT TYPE III D84**

IP20    3,3220 



kabelgoot galvanisé - onder verdeelkast met ingangen zijkant  
 cable duct galvanised - under distribution box with cable entries on the side

Ref		Price €
KG03.11MG	grey tex	128,34
KG03.RAL 9001	Cream	144,90

**Dimensions**  
 L1200xB340xD84

**Materials**  
 aluminium RAL 9001  
 galvanized 11MG

*built-up*  
 frontplaat galvanisé of gelakt RAL9001  
 cover plate galvanised or varnished RAL9001

**KG04/.. - KABELGOOT TYPE IV D84**

IP20   



kabelgoot galvanisé - onder verdeelkast met ingangen op frontplaat  
 cable duct galvanised - under distribution box with entries on cover plate

Ref		Price €
KG04.11MG	grey tex	132,48
KG04.RAL 9001	Cream	149,04

**Dimensions**  
 L1200xB340xD84

**Materials**  
 aluminium RAL 9001  
 galvanized 11MG

*built-up*  
 frontplaat galvanisé of gelakt RAL9001  
 cover plate galvanised or varnished RAL9001



## INDOOR | Accessories | KABELGOOT

Kabelgoot voor toepassing onder en boven verdeelkast - onderstel steeds in galvanisé - frontplaat verkrijgbaar in galvanisé of gelakt RAL 9001  
 Cable duct for application under and above distribution box - base always galvanized - cover plate available in galvanized or painted finish RAL 9001

### KG05/.. - KABELGOOT TYPE V

IP20    3,2250 



kabelgoot galvanisé - boven verdeelkast 66cm  
 cable duct galvanized - above distribution box 66cm

#### Dimensions

↔ L660xB340xD54

#### Options

KG11 - OPTIE VOOR KABELGOOT	€ 10,14
KG12 - OPTIE VOOR KABELGOOT	€ 11,39
KG13 - OPTIE VOOR KABELGOOT	€ 11,39

#### Materials

aluminium	RAL 9001
galvanized	11MG

#### Ref

KG05.11MG	grey tex	57,96
KG05.RAL 9001	Cream	72,45

#### Price €

**built-up**  
 frontplaat galvanisé of gelakt RAL9001  
 cover plate galvanized or varnished RAL9001

### KG06/.. - KABELGOOT TYPE VI

IP20    3,0000 



kabelgoot galvanisé - boven verdeelkast 76cm  
 cable duct galvanized - above distribution box 76cm

#### Dimensions

↔ L760xB340xD54

#### Options

KG11 - OPTIE VOOR KABELGOOT	€ 10,14
KG12 - OPTIE VOOR KABELGOOT	€ 11,39
KG13 - OPTIE VOOR KABELGOOT	€ 11,39

#### Materials

aluminium	RAL 9001
galvanized	11MG

#### Ref

KG06.11MG	grey tex	62,10
KG06.RAL 9001	Cream	78,66

#### Price €

**built-up**  
 frontplaat galvanisé of gelakt RAL9001  
 cover plate galvanized or varnished RAL9001

Kabelgoot voor toepassing onder en boven verdeelkast - onderstel steeds in galvanisé - frontplaat verkrijgbaar in galvanisé of gelakt RAL 9001  
 Cable duct for application under and above distribution box - base always galvanized - cover plate available in galvanized or painted finish RAL 9001

**KG07/.. - KABELGOOT TYPE VII**

IP20   



kabelgoot galvanisé - met opbouwdoos voor transfo's + DIN rail  
 cable duct galvanised - with built-up box for transformers + DIN rail

Ref		Price €
KG07.RAL 9001	Cream	126,27

**Dimensions**  
 L660xB340xD154

**Options**  
 KG11 - OPTIE VOOR KABELGOOT € 10,14  
 KG12 - OPTIE VOOR KABELGOOT € 11,39  
 KG13 - OPTIE VOOR KABELGOOT € 11,39

**Materials**  
 aluminium RAL 9001

**built-up**  
 compleet 66cm met chassisplaat en opbouwdoos in RAL 9001  
 complete 66cm with chassis and build-up box in RAL 9001

**KG08/.. - KABELGOOT TYPE VIII**

IP20   



kabelgoot galvanisé - met opbouwdoos voor transfo's + DIN rail  
 cable duct galvanised - with built-up box for transformers + DIN rail

Ref		Price €
KG08.RAL 9001	Cream	142,83

**Dimensions**  
 L760xB340xD154

**Options**  
 KG11 - OPTIE VOOR KABELGOOT € 10,14  
 KG12 - OPTIE VOOR KABELGOOT € 11,39  
 KG13 - OPTIE VOOR KABELGOOT € 11,39

**Materials**  
 aluminium RAL 9001

**built-up**  
 compleet 76cm met chassisplaat en opbouwdoos in RAL 9001  
 complete 76cm with chassis and build-up box in RAL 9001

**KG09/.. - OPTIE VOOR KABELGOOT**

IP20   

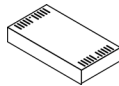

supplement - opbouwdoos voor transfo's + chassisplaat + DIN rail  
 supplement - built-up box for transformers + chassis + DIN rail

Ref		Price €
KG09.RAL 9001	Cream	80,73

**Dimensions**  
 L660xB340xD110

**Materials**  
 aluminium RAL 9001

**built-up**  
 voor type III 66cm - zonder onderstel goot  
 for type III 66cm - without base cable duct

**KG10/.. - OPTIE VOOR KABELGOOT**

IP20   

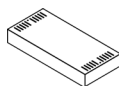

supplement - opbouwdoos voor transfo's + chassisplaat + DIN rail  
 supplement - built-up box for transformers + chassis + DIN rail

Ref		Price €
KG10.RAL 9001	Cream	93,15

**Dimensions**  
 L760xB340xD110

**Materials**  
 aluminium RAL 9001

**built-up**  
 voor type IV 76cm - zonder onderstel goot  
 for type IV 76cm - without base cable duct

## INDOOR | Accessories | KABELGOOT

Kabelgoot voor toepassing onder en boven verdeelkast - onderstel steeds in galvanisé - frontplaat verkrijgbaar in galvanisé of gelakt RAL 9001  
 Cable duct for application under and above distribution box - base always galvanized - cover plate available in galvanized or painted finish RAL 9001

### KG11/.. - OPTIE VOOR KABELGOOT

IP20   

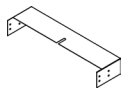

supplement - aanpassingsstuk voor hoogteregeling  
 supplement - adaptation piece for height control

**Dimensions**  
 L338xB50xD50

**Materials**  
 aluminium RAL 9001  
 galvanized 11MG

Ref		Price €
KG11.11MG	grey tex	9,11
KG11.RAL 9001	Cream	12,01

**built-up**

uitschuifbaar stuk voor kabelgoot 66cm of 76cm  
 extending piece for cable duct 66cm or 76cm  
 min. verpakking 10 stuks  
 min. packaging 10 pieces

### KG12/.. - OPTIE VOOR KABELGOOT

IP20   

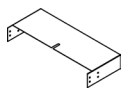

supplement - aanpassingsstuk voor hoogteregeling  
 supplement - adaptation piece for height control

**Dimensions**  
 L338xB100xD50

**Materials**  
 aluminium RAL 9001  
 galvanized 11MG

Ref		Price €
KG12.11MG	grey tex	10,14
KG12.RAL 9001	Cream	14,08

**built-up**

uitschuifbaar stuk voor kabelgoot 66cm of 76cm  
 extension for cable duct 66cm or 76cm  
 min. verpakking 10 stuks  
 min. packaging 10 pieces

### KG13/.. - OPTIE VOOR KABELGOOT

IP20   

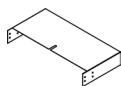

supplement - aanpassingsstuk voor hoogteregeling  
 supplement - adaptation piece for height control

**Dimensions**  
 L338xB150xD50

**Materials**  
 aluminium RAL 9001  
 galvanized 11MG

Ref		Price €
KG13.11MG	grey tex	11,39
KG13.RAL 9001	Cream	16,15

**built-up**

uitschuifbaar stuk voor kabelgoot 66cm of 76cm  
 extension for cable duct 66cm or 76cm  
 min. verpakking 10 stuks  
 min. packaging 10 pieces





## ALGEMENE VERKOOPSVOORWAARDEN

### TOEPASSING VAN DE VOORWAARDEN

Deze algemene voorwaarden zijn van toepassing op alle bestellingen en verkopen gesloten door psmlighting bv, behoudens afwijkende overeenkomst die echter uitdrukkelijk moeten worden bedongen op de bestelbon of op een ander geschrift. Algemene of inkoopvoorwaarden van de kopers worden nooit in aanmerking genomen. Door een bestelling te plaatsen, verklaart de koper zich akkoord met deze algemene voorwaarden.

De in de catalogus opgenomen prijslijst vervangt alle voorgaande en de erin opgenomen prijzen (in Euro) en voorwaarden zijn onmiddellijk geldig vanaf de dag van publicatie.

Psmlighting is niet verantwoordelijk voor eventuele drukfouten.

Psmlighting behoudt zich het recht voor om te allen tijde en zonder voorafgaande verwittiging de prijzen, ontwerpen en technische gegevens van elk product opgenomen in de catalogus of prijslijst te wijzigen. Voormelde wijzigingen kunnen geen aanleiding geven tot het verschuldigd zijn van een schadevergoeding. Prijzen zijn steeds onderhevig aan de eventuele schommelingen van de prijzen van grondstoffen, lonen of valuta. De aangegeven prijzen zijn exclusief belastingen, taksen en heffingen (Recupel).

De koper zal zich onthouden van enige verspreiding of mededeling aan het publiek of aan derden van de netto-prijzen en/of kortingen die hij van psmlighting ontvangt. De koper zal de door psmlighting gehanteerde prijslijst evenmin via het internet openbaar maken. Bij miskenning van deze vertrouwelijkheidsverplichting zal de koper psmlighting een forfaitaire schadevergoeding betalen ten bedrage van 5000 euro per betrokken product, onverminderd het recht van psmlighting bij hogere schade een hogere schadevergoeding te vorderen.

### BESTELLINGEN & OFFERTES

#### Bestellingen

Bestellingen dienen steeds schriftelijk overgemaakt te worden, gebruik makend van de in de prijslijst vermelde referenties. Indien bestellingen vooraf telefonisch worden doorgegeven, moeten deze hoe dan ook nog schriftelijk aan psmlighting worden bevestigd met de vermelding: "reeds telefonisch doorgegeven". Bestellingen zijn pas geldig wanneer ze door psmlighting schriftelijk bevestigd worden.

Vermijd onduidelijkheid: kleurnaam en kleurcode, artikelnaam en artikelcode moeten overeenstemmen. Bij de bestelling van een niet-standaardartikel zoals een profiel, vergroting of ander artikel op maat, moet de koper ter verduidelijking een tekening bij de bestelling voegen. Bij de bestelling van plafondbasissen moet vermeld worden hoeveel gaten er moeten worden voorzien en waar die moeten komen. Ook daarvoor dient de koper zelf een tekening te voorzien bij de bestelling. Prijs voor 003.Ralkost is een nettoprijs.

Elke annulering of wijziging van bestelling moet schriftelijk aangevraagd worden én aanvaard worden door psmlighting.

Ingeval van annulering van de gedane bestelling van goederen is door de koper een schadevergoeding verschuldigd forfaitair vastgesteld op 35% van het bestelde bedrag, dit uit hoofde van kosten en winstderving. Inbouwspots en maatwerk (samengestelde stukken, gemonteerde vergrotingen, speciale profielen, enz.) worden onder geen enkel beding teruggenomen noch gecrediteerd. Voor gewijzigde bestellingen of foutieve bestellingen van standaard producten wordt een administratieve kost van 15% op het nettobedrag met een minimum van €25 (excl. BTW) aangerekend.

Iedere opgegeven termijn, zelfs in geval van vervaldatum, is slechts benaderend; vertraging kan nooit aanleiding geven tot vernietiging van de bestelling, weigering van de goederen noch schadevergoeding. Aangekochte goederen kunnen noch teruggegeven, noch geruild worden.

#### Offertes

Offertes moeten steeds schriftelijk aangevraagd worden. Telefonisch doorgegeven prijzen zijn informatief, NIET bindend. Alle prijzen op offerte zijn steeds brutoprijzen, tenzij anders aangegeven. Prijzen voor niet-standaard artikelen worden nooit telefonisch doorgegeven. In geval van bestellingen volgens offerte, dient het offertenummer op de bestelbon te worden vermeld en als bijlage bij de bestelling te worden toegevoegd (ondertekend voor akkoord). Indien deze voorwaarden niet gerespecteerd worden, is psmlighting niet verantwoordelijk voor misverstanden. Behoudens andersluidende bepalingen, zijn de offertes steeds vrijblijvend en hebben een geldigheidsduur van 1 maand na offertedatum.

#### TRANSPORT EN LEVERING

De goederen worden EX WORKS verzonden op risico en voor rekening van de koper ongeacht de wijze van verzending. Tenzij anders bepaald, betaalt de koper het laden, de kosten van douane, verzending en de verzekering dienstig voor de verzending. Voor verzending van goederen die binnen de standaardmaten van onze transporteur vallen, wordt een standaardtarief per colli aangerekend. Voor verzending van buitenmaatse afmetingen (bv. lengtes van meer dan 1,60m) wordt een meerprijs gefactureerd afhankelijk van gewicht, afmeting en bestemming.

De bewaring van de goederen in afwachting van de levering of de afhaling geschiedt op risico en op kosten van de koper. Psmlighting, noch haar personeel kunnen enige verantwoordelijkheid ten laste gelegd worden voor de wijze van vervoer door de koper, zelfs wanneer geholpen wordt bij het laden. Vanaf de ontvangst van de goederen draagt de koper alle verantwoordelijkheid voor verlies, vernietiging of verdwijning ervan.

Indien de koper de goederen niet afhaalt, of indien de levering niet kan gebeuren wegens omstandigheden te wijten aan de koper, wordt het recht voorbehouden om, na het verstrijken van een termijn van 15 dagen de overeenkomst als ontbonden te beschouwen en dit zonder voorafgaande ingebrekestelling in welk geval de hierboven bepaalde forfaitaire schadevergoeding vastgesteld op 35% eveneens van toepassing is.

Psmlighting behoudt zich het recht voor gedeeltelijke leveringen te doen, op basis van de

beschikbare hoeveelheden. Psmlighting draagt in geen geval het risico voor overmacht. Onder overmacht wordt verstaan iedere gebeurtenis waar psmlighting redelijkerwijze geen controle over heeft, inbegrepen maar niet beperkt tot grondstoftekorten, onregelmatigheden bij toeleveranciers, stakingen, onderbrekingen in het vervoer, oorlogsdaden, brand, verordeningen of voorschriften van de regering of de administratie.

#### INSTALLATIE

De armaturen worden geleverd zonder lampen. Het installeren, aansluiten en testen van de verlichtingsarmaturen dient altijd te gebeuren door een erkend elektro-installateur en dit volgens de plaatselijk geldende reglementering en officiële instructies. De installateur is ervoor verantwoordelijk dat de gebruikte voorschakelapparatuur voldoet aan de geldende CE-norm. Kosten voor installatie zijn nooit ten laste van psmlighting. Kosten voor reparatie door foutieve installatie, installatie niet-conform aan de opgegeven installatierichtlijnen of verkeerd gebruik kunnen niet op psmlighting verhaald worden.

De technische gegevens vermeld op de geleverde producten na datum editie catalogus hebben voorrang op technische gegevens vermeld in de catalogus. Gelieve steeds onze website te raadplegen waar de meest recente informatie op weergegeven wordt en waar u de errata-lijst kunt raadplegen. Deze is steeds up to date en geeft alle technische en mechanische wijzigingen weer van de producten. Ons B2B portaal staat steeds tot uw beschikking waarop u de laatste trends en wijzigingen omtrent onze producten kunt opvolgen.

Hierbij verklaart psmlighting dat:

- Grondspots (LAVA-ETNA) met ALU behuizing niet geschikt zijn voor buiten;
- Armaturen in kleur 14, alu satiné enkel voor gebruik binnenshuis zijn;
- 5BB, dubbel behandelde inox, aangeraden wordt voor installatie aan de kust.

#### KLACHTEN & GARANTIE

##### Klachten

De koper is gebonden de inhoud van de levering en leveringsbon na te zien bij ontvangst. Om geldig te zijn moeten alle klachten nopens de geleverde goederen en hun aantallen binnen de 24 uur na levering bij wijze van opmerkingen op het borderel van de transporteur, en per aangetekend schrijven aan psmlighting zijn overgemaakt. Het aantal colli's moet bij aanlevering steeds onmiddellijk nageteld worden. Manco colli's moeten onverwijld, en binnen de 24 uur na levering, onmiddellijk gemeld worden aan psmlighting per email en moeten vermeld worden op het borderel van de transporteur. De klachten die betrekking hebben op verborgen gebreken moeten per aangetekend schrijven ter kennis gebracht worden binnen de acht dagen na ontdekking. De poststempel is determinerend voor het bepalen van een al dan niet tijdig protest. Alle klachten moeten worden gestaafd met digitale foto's die per e-mail aan psmlighting worden doorgestuurd. Klachten inzake foutieve installatie, installatie niet-conform aan onze installatierichtlijnen of verkeerd gebruik kunnen niet op psmlighting verhaald worden. Klachten schorten de betalingsplicht niet op.

## Garantie

Psmlighting garandeert dat de geleverde goederen correct werden geproduceerd, met als voorwaarde dat de aansprakelijkheid enkel de verplichting tot vervanging omvat - zonder kosten voor de koper - van de goederen of vervangstukken waarvan psmlighting erkent dat ze foutief werden geproduceerd, dit alles exclusief enige andere mogelijkheid tot vergoeding en op voorwaarde dat de koper aan al zijn verplichtingen tegenover psmlighting heeft voldaan en psmlighting binnen de 8 dagen na het defect zicht heeft voorgedaan, hiervan op de hoogte werd gesteld.

De koper erkent dat deze garantie geldt voor een periode van 2 jaar te rekenen vanaf de datum van aankoop. Psmlighting is overeenkomstig deze garantie niet aansprakelijk indien zich enig defect voordoet als gevolg van slijtage van de onderdelen, als gevolg van opzettelijke beschadiging door of nalatigheid vanwege de koper of als gevolg van schade te wijten aan ongepast gebruik door de operator, indien de koper de instructies in de technische documentatie, die werd meegeleverd door psmlighting niet heeft gevolgd, indien de koper materiële wijzigingen heeft aangebracht zonder toestemming van psmlighting. Om de garantie te kunnen genieten moet de koper eventuele defecten binnen de hierboven vastgestelde termijn aan psmlighting meedelen, daarbij dient hij de aard van het defect te vermelden, alsook alle verdere relevante informatie.

## BETALING

De geleverde goederen blijven in ieder geval eigendom van psmlighting tot de volledige vereffening van de koopprijs en alle verdere vorderingen voor alle leveringen uit tegenwoordige en toekomstige overeenkomsten. Het eigendomsvoorbehoud geldt eveneens wanneer de goederen geïnstalleerd of verwerkt werden. Ingeval van verwerking van de goederen, verkoop aan derden of op krediet wordt het ontstane vorderingsrecht onze eigendom tot volledige vereffening zoals hiervoor bepaald. Tijdens deze periode neemt de koper de plichten en de verantwoordelijkheid van bewaarder op zich voor de geleverde producten en hij verbindt er zich bijgevolg toe deze te bewaken en te verzekeren tegen alle oorzaken van beschadiging, vernietiging, diefstal, brand, verlies, enz.

Behoudens andersluidend beding, gebeurt de betaling met voorafbetaling door overschrijving. Bankkosten zijn ten laste van de koper.

Wanneer op schriftelijk verzoek van de koper de factuur wordt uitgeschreven op naam van een derde, blijft de koper te allen tijde en in alle omstandigheden persoonlijk gehouden t.o.v. psmlighting tot naleving van alle verbintenissen die uit de overeenkomst en huidige algemene voorwaarden voortvloeien.

Elk bedrag dat onbetaald blijft op de vervaldag maakt alle verschuldigde sommen opeisbaar, ook deze van niet-vervallen facturen. Welke betalingsovereenkomst er ook moge gemaakt zijn. Psmlighting heeft het recht de onbetaalde goederen terug te eisen, waar zij zich ook mogen bevinden, zonder enig verhaal of verzet van de koper.

In geval van niet-betaling van de factuur op de vervaldag is er van rechtswege en zonder voorafgaande ingebrekestelling

verwijnterest verschuldigd, berekend tegen de intrestvoet bepaald in de wet van 2 augustus 2002 betreffende de bestrijding van de betalingsachterstand bij handelstransactie. De interesten zijn verschuldigd voor elke begonnen maand. De niet-betaalde sommen worden bovendien vermeerderd met een overeengekomen forfaitaire schadevergoeding van 10% van het verschuldigde bedrag met een minimum van €65, onverminderd het recht van psmlighting om vergoeding van aanmanings- en eventuele gedingskosten te vragen, zelfs indien termijnen van respijt zijn toegekend.

In geval van aanhoudend betalingsachterstal heeft psmlighting het recht de levering te annuleren, zelfs als deze leveringen vooraf al waren afgesproken.

Het protest tegen de factuur dient bij aangetekend schrijven te gebeuren binnen de acht dagen na factuurdatum. De poststempel is determinerend voor het bepalen van een al dan niet tijdig protest.

## WETGEVING

Op al onze overeenkomsten vinden de bepalingen van het Belgisch intern verbintenissenrecht en handelsrecht toepassing, met uitsluiting van het Weens Koopverdrag. In geval van betwisting zijn uitsluitend de rechtbanken van de zetel van de vennootschap territoriaal bevoegd.

## CONDITIONS GENERALES

### APPLICATION DES CONDITIONS

Ces conditions de vente s'appliquent à toutes les commandes, ventes ou prestations par psmlighting bv, sauf disposition contraire écrite stipulée sur les bons de commandes ou sur un autre document écrit. En passant une commande, l'acheteur se déclare d'accord avec les conditions présentes. Les conditions d'achat des acheteurs ne sont jamais prises en considération.

Cette liste de prix remplace toutes les précédentes. Ces prix (en Euro) et conditions seront valables à partir du jour de publication. Psmlighting n'est pas responsable de fautes d'impressions éventuelles.

Psmlighting se réserve le droit de modifier à tout moment et sans avis préalable, les prix, designs et données techniques (eg. dimensions) de tout produit figurant dans le catalogue et la liste des prix. Les modifications précitées ne peuvent pas donner lieu à des demandes d'indemnité. Les prix sont toujours susceptibles d'éventuelles fluctuations des prix des matières premières, des salaires ou la devise. Les prix indiqués sont toujours hors TVA et hors taxes (Recupel).

Psmlighting interdit la publication des prix bruts et/ou prix nets sur internet. L'acheteur ne peut dans aucun cas déclarer les prix ou la remise au grand public ou aux tiers. Chaque infraction sera pénalisée à €5000 par prix qui est publié, sans préjudice du droit de psmlighting de demander une indemnisation plus élevée en cas de dommage plus important.

### COMMANDES ET OFFRES

#### Commandes

Les commandes doivent être transmises par écrit en utilisant les références mentionnées dans la liste des prix. Si les commandes sont passées

par téléphone, elles doivent en tout cas être confirmées par écrit, en précisant : « commande déjà passée par téléphone ». Les commandes sont valables après confirmation par écrit de la part de psmlighting.

Evitez toute confusion : le nom et le code du coloris, le nom et le code d'article doivent correspondre. Un dessin doit être ajouté aux commandes d'articles non-standards, comme des profils, des anneaux d'adaptation ou d'autres produits sur mesure, afin de préciser votre commande. En commandant des bases pour le plafond, veuillez mentionner le nombre des trous et leurs positions. Une commande de tel produit doit aussi être confirmée par écrit avec un dessin technique ajouté. La production de produits sur mesure ne commencera qu'après l'accord par écrit de notre client. L'accord verbal ne sera pas accepté. Le prix pour 003.Ral est un prix net.

Toute annulation ou modification d'une commande doit être faite par écrit et acceptée par psmlighting. En cas d'acceptation, psmlighting a droit de demander une indemnité forfaitaire de 35% du montant de la facture pour cause de frais et perte de bénéfices. Les articles non-standards (ex. armatures sur mesure) ou des spots encastrés ne sont repris ou crédités à aucune condition. Des frais administratifs de 15% sur la valeur nette, avec un minimum de €25 (hors TVA) seront facturés pour les commandes modifiées ou fautives des articles standards.

Tout délai de livraison, même en cas de date d'échéance, n'est donné qu'à titre indicatif et n'engage pas psmlighting. Le retard dans la livraison convenue ne peut en aucun cas donner lieu à des indemnités ou à la résolution du contrat. Les articles achetés ne peuvent ni être retournés, ni échangés.

#### Offres

Les demandes d'offres doivent toujours se passer par écrit. Les prix qui sont passés par téléphone, ne sont qu'informatifs, PAS contraignants. Tous les prix qui sont sur offre, sont toujours des prix bruts, sauf indiqué autrement. Les prix des articles non-standards ne seront jamais passés par téléphone au client, mais toujours par écrit. En cas de commande suivant une offre, le numéro de l'offre doit être mentionné et une copie de l'offre doit être ajoutée à la commande (signée pour accord). Si ces conditions ne sont pas respectées, psmlighting n'est pas responsable pour des malentendus. Sauf stipulations contraires, les offres n'engagent en rien et restent valables jusqu'à 1 mois après la date de l'offre.

### TRANSPORT ET LIVRAISON

Le transport des marchandises s'effectue EX WORKS aux risques et périls de l'acheteur, quel que soit le mode de transport et les conditions. Sauf stipulation contraire, l'acheteur paie le chargement, le frais de douane, l'envoi et l'assurance de l'envoi. L'envoi des colis qui ont des dimensions standards pour notre transporteur, seront facturés à un prix standard par colli. L'envoi des colis avec dimensions non-standards (ex. de longueurs de plus de 1,60m) est facturé à un prix supplémentaire dépendant du poids, des dimensions et de la destination. Les devoirs et la responsabilité d'un consignataire des produits attendant l'enlèvement ou la livraison doivent être assumés par l'acheteur.

Ni psmlighting, ni son personnel ne sera responsable du mode de transport de l'acheteur,

même en cas d'assistance lors du chargement. Dès la réception des marchandises, l'acheteur supporte toute responsabilité en ce qui concerne la perte, la destruction ou la disparition des marchandises.

Si l'acheteur refuse d'accepter la livraison ou rend impossible la livraison des marchandises, psmlighting a le droit de résilier de plein droit le contrat au détriment de l'acheteur au bout de 15 jours calendrier, sans constitution en demeure précédente. En ce cas, l'indemnité de 35% comme indiqué ci-dessus s'applique.

Des livraisons partielles sont toujours admises. L'acheteur endosse en tout cas le risque de force majeure. Par force majeure il faut entendre tout événement sur lequel psmlighting n'a raisonnablement aucun contrôle, en ce compris, mais de façon non limitative, des ruptures de stock de matières premières, des irrégularités chez les fournisseurs, des grèves, arrêts de transport, actes de guerre, incendies, règlements ou dispositions du gouvernement ou de l'administration.

#### INSTALLATION

Les armatures sont toujours livrées sans les sources lumineuses. Le placement, le raccordement et l'essai des armatures doivent toujours être effectués par un installateur électricien agréé, suivant le règlement sur les installations électriques en vigueur. L'installateur est responsable de l'utilisation des ballasts, transfo et d'autre matériel de commutation conformes aux normes CE (compatibilité électromagnétique) en vigueur. Les frais d'installation ne sont jamais à la charge de psmlighting. Les frais de réparation dus à une installation fautive, non-conforme aux directives d'installation ou à un usage inapproprié ne seront pas supportés par psmlighting.

Les données techniques mentionnées sur les produits livrés après la date d'édition du catalogue ont priorité sur les données techniques mentionnées dans le catalogue. Veuillez toujours consulter notre site où les informations les plus récentes sont disponibles et où vous pouvez consulter la liste des errata. Elle est toujours à jour et reflète toutes les modifications techniques et mécaniques des produits. Notre portail B2B est toujours à votre disposition où vous pouvez suivre les dernières tendances et les changements concernant nos produits.

A cet égard, psmlighting déclare que :

- Les spots à encastrer dans le sol (LAVA-ETNA) avec boîtier en ALU ne peuvent pas être installés à l'extérieur.
- Les armatures en couleur 14, alu brossé ne peuvent être utilisées qu'à l'intérieur.
- Les articles en 5BB, inox double traité, est conseillé pour installation à la côte.

#### PLAINTES ET GARANTIE

##### Plaintes

L'acheteur est tenu de contrôler immédiatement la livraison et de vérifier le contenu de la livraison et les termes du bon de livraison dès réception. Les réclamations des articles livrés doivent être transmises à psmlighting bvba dans les 24 heures après réception des marchandises, soit par une note sur le bordereau du chauffeur, soit par lettre recommandée. Le nombre de colis doit être compté et vérifié au moment de la

livraison. En cas de colis manquants, psmlighting doit être informé par écrit immédiatement et une remarque doit être notée sur le bordereau du chauffeur. Réclamations par rapport aux vices cachés doivent être transmis par lettre recommandée dans les 8 jours après la découverte. Le cachet de la poste détermine si la plainte a été introduite à temps. Toute plainte doit s'accompagner de photos digitales, à envoyer à psmlighting par e-mail. Des plaintes concernant des installations fautives, des installations non-conformes à les directives officielles ne peuvent pas se faire rembourser par psmlighting. Les plaintes ne suspendent pas l'obligation de paiement.

##### Garantie

Psmlighting garantit que les marchandises livrées sont fabriquées correctement. Notre responsabilité se limite donc uniquement à l'obligation de remplacer, sans frais pour l'acheteur, les marchandises ou pièces détachées auxquelles nous reconnaissons un défaut de fabrication, à l'exception de toute autre possibilité de compensation, et à condition que l'acheteur ait rempli toutes ses obligations à notre attention et que nous ayons été informés du défaut dans les 8 jours après la découverte. L'acheteur convient que la présente garantie est valable pour une période de 2 ans. Cette garantie n'engage pas la responsabilité de psmlighting lorsque le défaut, quel qu'il soit, concerne les pièces soumises à l'usure, résulte des négligences délibérées de la part de l'acheteur, survient lorsque l'acheteur n'a pas respecté les instructions mentionnées dans la documentation technique fournie par psmlighting, survient lorsque l'acheteur a apporté une modification physique à l'équipement sans l'autorisation de psmlighting.

Afin de bénéficier de cette garantie, l'acheteur tient à informer psmlighting de tout défaut dans les délais précisés ci-dessus et de spécifier la nature du défaut ainsi que toutes autres informations valables.

##### PAIEMENT

Les marchandises restent la propriété de psmlighting jusqu'au paiement complet des montants des factures, en ce compris les frais, intérêts, indemnités et taxes éventuelles, même si les marchandises ont déjà été revendues ou installés. Psmlighting se réserve le droit de reprendre les marchandises non payées où qu'elles se trouvent, sans que l'acheteur ne puisse exercer aucun recours ni aucune opposition. Pendant cette période, l'acheteur est réputé assumer les devoirs et la responsabilité d'un consignataire des produits livrés et il s'engage par conséquent à en exercer la garde et de les assurer contre tous risques de dommage, destruction, vol, incendie, perte, etc.

Sauf stipulation contraire, le paiement se fait à l'avance, par virement. Les frais bancaires sont toujours à la charge de l'acheteur.

Si, sur demande par écrit de la personne qui passe la commande, la facture est émise au nom d'un tiers, la personne qui commande reste toujours et en toutes circonstances personnellement responsable vis-à-vis psmlighting concernant le respect de tout engagement et des présentes conditions générales.

Le défaut de paiement à l'échéance donnera lieu à l'exigibilité de toutes les sommes non encore échues. Psmlighting se réserve le droit

de reprendre les marchandises non payées où qu'elles se trouvent, sans que l'acheteur ne puisse exercer aucun recours ni aucune opposition.

En cas de non-paiement de la facture à l'échéance, des intérêts de retard sont dus de plein droit et sans mise en demeure préalable, calculés au taux prévu par la loi du 2 août 2002 concernant la lutte contre le retard de paiement dans les transactions commerciales. L'intérêt est dû pour chaque mois entamé. Les montants impayés seront en outre augmentés d'une indemnité forfaitaire convenue de 10 % du montant dû, avec un minimum de 65 €, sans préjudice du droit de psmlighting de réclamer une indemnisation pour les frais de rappel et les éventuels frais de justice, même si des délais de grâce ont été accordés.

En cas de factures impayées continues, psmlighting a le droit d'annuler les livraisons, même s'ils ont été déjà convenus. La protestation contre la facture doit être faite par lettre recommandée pendant les 8 jours après date de facturation. Le cachet de la poste détermine si la plainte a été introduite à temps.

#### LEGISLATION

Tout contrat est régi par le droit Belge à l'exception de la Convention de Vienne sur la vente internationale de marchandises. En cas de litige, seuls les tribunaux du siège social de la société sont compétents.

## GENERAL TERMS AND CONDITIONS

#### APPLICATION OF THE GENERAL TERMS AND CONDITIONS

Unless explicitly provided otherwise on the order form or on any other document, all orders, sales or performances by psmlighting bv are subject to the present general terms and conditions. Every sale is subject to the buyer's assent to the terms and conditions stated herein. Any additional, different or conflicting terms and conditions on any document issued by the buyer at any time are hereby objected to by psmlighting and any such document shall be fully inapplicable to any sale made hereunder and shall not in any way be binding to psmlighting.

This pricelist replaces all previous ones and the prices (in Euro) and terms stated are valid as from the date of publication. Psmlighting cannot be held liable for any printing errors.

Psmlighting reserves the right to change the price, design and technical data (ex. dimensions) of any product mentioned in the catalogue or pricelist at any time without prior notice. These changes cannot give cause for compensation. All prices quoted are subject to alteration due to raw material price fluctuations, wage or currency fluctuations. All prices quoted are excluding customs, duties, local or other taxes.

Psmlighting forbids the publication of gross and/or net prices on the internet. No buyer may declare prices or discounts to third parties. There will be a penalty of €5000 per price that is issued, without prejudice to the right of psmlighting to claim higher compensation in the case of higher damage.



## ORDERS AND OFFERS

### Orders

Orders must always be transmitted in writing using the references stated in the pricelist. Orders transmitted by telephone must always be confirmed in writing to psmighting, stating: "confirmation of an order already transmitted by telephone". All orders are subject to written acceptance and confirmation by psmighting. Avoid any lack of clarity: colour name and colour code, article name and article code must correspond. When ordering non-standard articles like profiles, custom-made rings or other customised products, the buyer must always include a drawing to the order. When ordering a ceiling base, the number of holes and the position of the holes must be clearly mentioned on the order form. An order for this kind of customised products is confirmed by psmighting by sending the customer a drawing of the base for approval. The production of custom-made products will only start after receipt of the written approval. Verbal approval will not be accepted. The price quoted for 003.Ral is a net price.

All order cancellations or modifications must be notified in writing and are subject to psmighting's written acceptance and confirmation. In case of cancellation, psmighting shall be entitled to compensation amounting to 35% of the invoice value for reason of costs and loss of profits. Non-standard items (ex. made-to-measure goods) or built-in spots are under no condition neither taken back nor credited. An administration fee of 15% of the net value, with a minimum of €25 (excl. VAT) will be charged for modified or incorrect orders of standard products.

Any indicated delivery term, even in case of an expiry date, is indicative and non-binding on the seller. A delay, for whatever reason, shall never entitle the buyer to cancel the order, to refuse the goods or to claim compensation. Purchased goods cannot be returned, nor exchanged.

### Offers

Enquiries must always be made in writing. Verbally communicated prices are informative, NOT binding. All prices on offers are always gross prices, unless stated otherwise. Prices for non-standard items are never communicated by telephone. In case of orders following an offer, the offer number must be mentioned on the order and a copy of the offer must be attached to the order form, signed as approved. Unless stated otherwise, offers are not binding and are valid until 1 month after the date of issue of the offer.

### TRANSPORT AND DELIVERY

All goods are always shipped EX WORKS at the buyer's risk and at his expense, regardless of the mode of shipment and the terms and conditions. Unless otherwise agreed, the buyer shall pay the loading, clearing the goods for export, custom duties, shipment and insurance needed. Shipment of boxes that are considered to be standard dimensions for our forwarder, are invoiced per box. A surcharge is invoiced for shipment of boxes with non-standard dimensions (ex. Lengths over 1,60m) depending on the weight, the dimensions and the destination. All duties and responsibilities as keeper of the goods, awaiting the delivery or the pick-up of the goods, are at the risk and for the account of the buyer.

Psmighting nor its staff can be held liable for the buyer's manner of transport, even if psmighting's staff assists in loading. As from the moment he receives the goods, the buyer shall bear full responsibility for any loss, destruction or disappearance of the goods.

If the buyer refuses to accept delivery or explicitly states his unwillingness or inability to take receipt of the goods, psmighting has the right to withdraw from the contract to the buyer's disadvantage after a period of 15 calendar days, without prior proof of default. In this case, the above mentioned compensation of 35% is also applicable.

Psmighting is entitled to carry out partial deliveries based on the available quantities. In no event shall psmighting be liable for cases of force majeure. Force majeure is understood to be any event beyond psmighting's control, including but not restricted to shortage in raw materials, irregularities at our suppliers, strikes, transport interruptions, acts of war, fire and government or administration measures.

### INSTALLATION

All goods are delivered without bulbs. The connection and testing of the devices should always be performed by an acknowledged electrician following the official instruction guidelines for electrical installations. The electrician is responsible for using ballasts, transformers and other switch gear meeting the valid CE regulations. Psmighting shall in no case compensate any installation costs. In no event shall psmighting be liable for any direct or indirect, special, incidental or consequential damages resulting from incorrect installation, unsuitable use or non-observance of the present terms and conditions.

The technical data mentioned on the delivered products after date of publication of the catalogue take precedence over the technical data mentioned in the catalogue. Please always consult our website where the most recent information is displayed and where you can consult the errata list. This list is always up to date and reflects all technical and mechanical changes to the products. Our B2B portal is always at your disposal where you can follow the latest trends and changes concerning our products.

The seller hereby declares that:

- The well lights (LAVA-ETNA) with ALU housing are not suitable for outdoor use.
- The lighting fixtures in brushed ALU, colour code 14, are only suitable for indoor use.
- Article 5BB, double coated stainless steel, is recommended for use at the seaside.

### COMPLAINTS & WARRANTY

#### Complaints

The buyer must check the content of the delivery and the terms on the delivery note upon receipt. To be valid, all complaints about the delivered goods must have reached psmighting within 24 hours after delivery, either by statement on the carrier's document or by registered mail. The number of parcels delivered must be counted upon receipt. In case of missing parcels, a note must be made on the carrier's document and psmighting must be advised immediately. Complaints in connection to hidden faults, must be notified by registered mail within 8 days after

the discovery. The postmark will indicate if the complaint was made in due time. All complaints must be supported by means of digital pictures sent by e-mail.

In no event shall psmighting accept complaints regarding goods that have been installed incorrectly, without observance of our instruction guidelines or used in an unsuitable manner. Complaints do not relieve the buyer of the obligation to settle the invoice.

#### Warranty

Psmighting guarantees that the delivered goods are properly manufactured, under the condition that our liability will only consist of the obligation to replace the goods or spare parts of which we have acknowledged their improper manufacture at no cost to the buyer, excluding any other compensation possibility and on condition that the buyer will have performed all his obligations to us and that we have been notified of the defect within 8 days after occurrence of the defect. The buyer agrees that the present warranty is effective for a period of 2 years. Psmighting shall have no liability under this warranty so far as any defects arise with respect to wearing parts, as a result of willful damage or negligence of the buyer or damages due to inappropriate use by the operator, in case the buyer has not followed the instructions reported in the technical documentation supplied by the seller, in case the buyer has performed any physical modification to the equipment that was not authorized by psmighting).

In order to benefit from this warranty, the buyer must notify any defect to psmighting within the fixed time-frame of 8 days after identifying the problem and specify the nature of the defect together with all relevant information.

#### PAYMENT

Delivered goods remain property of psmighting until all invoices are completely settled, even if the goods have already been installed, used or sold to a third party or on credit. During this period, the buyer shall assume all duties and responsibilities as keeper of the goods. He thus undertakes to guard, protect and insure them against all forms of damage, destruction, theft, fire, loss, etc.

Unless otherwise agreed to in writing, all invoices must be paid in advance by bank transfer. Bank charges are for the account of the buyer.

In the event that, at the written request of the person placing the order, the invoice must be made out to the name of a third person, the person placing the order is always and under all circumstances personally responsible for the observance of all commitments in accordance with the present general terms and conditions.

Non-payment of a single invoice on the due date shall make all outstanding balances immediately payable, even if they have not yet fallen due for payment. Psmighting has the right to reclaim any unpaid goods, regardless were they are, without any redress or protest from the buyer.

In case of non-payment of invoices on due date, demur interest should be paid – legally fixed and without prior proof of default, and this calculated at a rate determined by law 2 august 2002 concerning the control of arrears in commercial relations.



The interests are due as from each first day of the month. Not paid sums are increased with the agreed compensation of 10% of the due amount with a minimum of €65 as compensation, with prejudice to psmighting right of reminder – and legal cost, even when terms of delay are granted.

In case of persistent payment arrears, psmighting has the right to cancel the delivery, even if these deliveries had already been agreed in advance. Protest against the invoice must be made by registered mail within 8 days after date of invoice. The postmark will indicate if the protest was made in due time.

#### APPLICABLE LAW

The agreement shall be governed and construed in accordance with the Belgian law, with the exception of the Vienna Convention on the International Sale of Goods. Any dispute shall be brought exclusively before the courts of the company's registered office.

## ALGEMEINE GESCHÄFTSBEDINGUNGEN

### ALLGEMEINER GELTUNGSBEREICH

Diese Geschäftsbedingungen gelten für alle Bestellungen, Verkäufe oder Leistungen von psmighting, es sei denn, dass die abweichende Vereinbarungen ausdrücklich auf der Bestellung oder einem anderen Dokument zugestimmt werden. Bedingungen der Käufer kommen nie in Betracht. Indem er eine Bestellung aufgibt, erklärt sich der Käufer mit den vorliegenden Verkaufsbedingungen einverstanden.

Diese Preisliste ersetzt alle vorherigen. Die Preise (in Euro) und Bedingungen sind gültig ab dem Tag der Veröffentlichung. Psmighting ist nicht für Druckfehler verantwortlich.

Psmighting behält sich das Recht vor, jederzeit und ohne vorangehende Benachrichtigung Preise, Entwürfe, und technische Daten der im Katalog oder in der Preisliste aufgeführten Produkte zu ändern. Oben erwähnte Änderungen berechtigen nicht zu Schadenersatzansprüchen. Jeder angegebener Preis unterliegt immer den eventuellen Preisschwankungen von Rohstoffen, Löhnen und Devisen. Alle in der Preisliste angegebenen Preise verstehen sich exklusive der Mehrwertsteuer und anderer Abgaben.

Der Käufer verpflichtet sich die von psmighting eingesetzten bruto und/oder netto Preisen nicht im Internet zu veröffentlichen. Bei Nichtbeachtung dieser Pflicht, wird der Käufer eine Pauschalentschädigung von 5000 Euro bezahlen per Produkt, von dem den bruto und/oder netto Preis bekanntgemacht ist, unbeschadet des Rechts von psmighting im Falle höheres Schadens einen höheren Schadenersatz zu fordern.

### BESTELLUNGEN UND ANGEBOTE

#### Bestellungen

Bestellungen müssen schriftlich übermittelt werden, unter Verwendung der in der Preisliste erwähnten Referenzen. Falls Bestellungen schon vorab telefonisch durchgegeben worden sind, müssen sie trotzdem noch schriftlich psmighting bestätigt werden mit dem Vermerk: „schon telefonisch durchgegeben“. Bestellungen sind nur dann verbindlich, wenn sie vom Verkäufer schriftlich bestätigt wurden.

Vermeiden Sie Undeutlichkeit: Name und Referenz der Farbe, Name und Referenz des Artikels müssen übereinstimmen. Bei Bestellung eines Nichtstandardartikels, wie etwa ein Profil, maßgeschneiderte Ausbauringe oder andere maßgeschneiderte Produkte, muss eine deutliche Skizze bei der Bestellung beigelegt werden. Bei Bestellung eines Deckenbasis muss die Zahl und Position der Löcher angegeben werden. Falls Profile bestellt werden, soll der Kunde auch eine Skizze hinzufügen. Die Bestellung von maßgeschneiderte Produkte wird erst produziert nach schriftliche Genehmigung der Kunde. Telefonische Genehmigung wird nicht akzeptiert. Der Preis für 003.Ral gilt als Nettopreis.

Jede Anfrage nach Stornierung oder Änderung der Bestellung muss schriftlich erfolgen und von psmighting schriftlich akzeptiert werden. Falls eine Bestellung storniert wird, hat psmighting Anspruch auf Schadenersatz von Pauschal 35% der Bestellwert, aufgrund Gebühren und Gewinnausfall. Sonderartikel (z.B. maßgeschneiderte Produkte) und Einbaustrahler werden unter keiner Bedingung zurückgenommen oder gutgeschrieben. Verwaltungsgebühren über 15% mit einem Mindestbetrag von €25 (excl. Mehrwertsteuer) werden berechnet für geänderte oder falsche Bestellungen.

Jeder erwähnte Liefertermin, sogar mit einem Verfalldatum gilt nur als Annäherungswert und ist unverbindlich. Eine Verzögerung, aus welchem Grund auch, berechtigt nie zur Stornierung der Bestellung, zur Verweigerung der Annahme der Materialien oder zu einem Schadenersatzanspruch. Angekaufte Waren werden unter keiner Bedingung zurückgenommen oder gutgeschrieben.

#### Angebote

Preisfragen müssen immer schriftlich passieren. Telefonisch übermittelte Preise sind nur informativ, NICHT verbindlich. Alle Preise auf einem Angebot sind immer Bruttopreise, wenn nicht anders angegeben. Preise für Sonderartikel werden nie telefonisch übermittelt. Bei Bestellungen aufgrund eines Angebots, muss die Angebotsnummer auf dem Bestellschein erwähnt werden, und eine Kopie des Angebots muss als Anlage bei der Bestellung gefügt werden (als einverstanden unterzeichnet). Wenn diese Bedingungen nicht respektiert werden, ist psmighting nicht für Missverständnisse verantwortlich. Vorbehaltlich anders lautender Bestimmungen sind die Angebote unverbindlich und bleiben bis 1 Monat nach dem Datum des Angebots gültig.

### VERSAND UND LIEFERUNG

Der Versand der bestellten Waren erfolgt immer EX WORKS auf Risiko und zu Lasten des Käufers, ungeachtet der Versandart und der Konditionen. Vorbehaltlich anderslautender Bestimmungen, zahlt der Käufer das Laden, die Zollkosten, Versand und Versicherung für das Versand. Für Versand von Waren die für unseren Spediteur standard sind, wird einen Standardpreis per Paket berechnet. Für Versand von Waren mit Nichtstandardabmessungen (z.B. Längen über 1,60m) wird einen Zusatzpreis abhängig von Gewicht, Abmessungen und Abstimmungsort berechnet. Die Lieferung oder Abholung entgegensehend, ist der Käufer gehalten, die Pflichten und Verantwortlichkeiten des Verwahrers der Ware zu übernehmen und diese in diesem Sinne zu überwachen, versichern gegen

Beschädigung, Vernichtung, Diebstahl, Feuer, Verlust, usw.

Weder psmighting, noch ihr Personal trägt die Verantwortung für die Versandart der Ware, sogar nicht, wenn beim Laden geholfen wird. Ab der Abnahmen der Waren trägt der Käufer die vollständige Verantwortung für Verlust, Vernichtung oder Verschwinden der Ware.

Falls der Käufer die Wareannahme verweigert, die Ware nicht abholt oder das Liefern unmöglich macht, ist psmighting dazu berechtigt, zu Lasten des Käufers von dem Vertrag zurückzutreten und zwar nach 15 Kalendertagen ohne vorabgehende Inverzugsetzung. In diesem Fall ist die obenerwähnte Pauschalentschädigung von 35% auch gültig.

Psmighting behält sich das Recht vor, je nach verfügbarer Menge Teillieferungen vorzunehmen. Auf keinen Fall trägt der Verkäufer das Risiko höherer Gewalt. Höhere Gewalt bedeutet: jedes Ereignis, das psmighting keineswegs beeinflussen kann, einschließlich aber nicht beschränkt auf Rohstoffmangel, Unregelmäßigkeiten bei den Lieferanten, Streiks, Verkehrsstörungen, Kriegshandlungen, Brand, Verordnungen oder Vorschriften der Regierung oder der Verwaltung.

### INSTALLATION

Alle Leuchten werden ohne Leuchtmittel geliefert. Die Montage, der Anschluss und die Prüfung der Leuchten muss nur durch autorisierte Elektro-Fachleute und nach der allgemeinen Reglementierung über die elektrischen Installationen vorgenommen werden. Der Installateur ist dafür verantwortlich, dass das verwendete Vorschaltgerät der geltenden CE-Norm entspricht, einschließlich der elektromagnetischen Kompatibilität. Installationsgebühren werden nie von psmighting übernommen. Schadenersatzansprüche infolge mangelhafter Installation, Nichteinhaltung der Montageanleitungen oder nicht fachgerechter Behandlung der Ware werden von psmighting nicht übernommen.

Die technischen Daten, die auf den gelieferten Produkten nach dem Datum des Ausgabekatalogs angegeben sind, haben Vorrang vor den im Katalog angegebenen technischen Daten. Bitte informieren Sie sich immer auf unserer Website, wo die neuesten Informationen angezeigt werden und wo Sie die Errata-Liste einsehen können. Diese ist immer auf dem neuesten Stand und berücksichtigt alle technischen und mechanischen Änderungen an den Produkten. Unser B2B-Portal steht Ihnen jederzeit zur Verfügung, wo Sie die neuesten Trends und Änderungen bezüglich unserer Produkte verfolgen können.

Hiermit erklärt der Verkäufer, dass:

- Bodenleuchten (LAVA-ETNA) mit ALUgehäuse nicht zur Verwendung im Freien geeignet sind.
- Leuchten in Farbe 14, Alu satiniert, nur zur Verwendung im Haus geeignet sind.
- 5BB, doppelt behandelter Edelstahl, bei Einsatz am Meer empfohlen ist.

## BESCHWERDE UND GEWÄHRLEISTUNG

### Beschwerde

Der Käufer ist verpflichtet die Lieferung unmittelbar nach Wareneingang zu kontrollieren und den Inhalt des Lieferscheines zu überprüfen. Beschwerden sind nur gültig, falls diese innerhalb von 24 Stunden nach Lieferung entweder mit einer Bemerkung auf das Lieferschein oder mit Einschreiben an psmlighting übergebracht werden. Bei Anlieferung der Ware, muss die Zahl der Frachtstücke immer gezählt werden. Falls Frachtstücke fehlen, muss der Verkäufer unmittelbar informiert werden und muss hierüber eine Bemerkung auf den Frachtbrief des Fahrers notiert werden.

Beschwerden mit Bezug auf versteckte Mängel müssen per Einschreiben innerhalb von acht Tagen nach der Entdeckung an psmlighting übergebracht werden. Der Poststempel bestimmt, ob die Beschwerde rechtzeitig erfolgt ist. Die Zahlungsverpflichtung wird durch Beschwerden nicht ausgesetzt. Alle Beschwerden müssen mit digitalen Fotos belegt sein, die per E-Mail an den Verkäufer geschickt werden. Beschwerden oder Schadensansprüche infolge mangelhafter Installation, Nichtbeachtung der Montageanleitungen oder nicht fachgerechter Behandlung der Ware werden von psmlighting nicht akzeptiert. Beschwerden setzen die Zahlungsverpflichtung nicht aus.

### Gewährleistung

Psmlighting garantiert, dass die gelieferten Waren einwandfrei hergestellt werden. Dabei gelten folgende Bedingungen: Erstens beschränkt sich die Haftung von psmlighting auf die Verpflichtung, diejenigen Waren oder Ersatzteile ohne Kosten für den Käufer zu ersetzen, deren fehlerhafte Produktion vom Verkäufer anerkannt wird. Dabei ist jede andere Vergütungsweise ausgeschlossen. Darüber hinaus soll der Käufer seine Verpflichtungen gegenüber psmlighting erfüllt haben und psmlighting vom Defekt innerhalb 8 Tagen nach dem Vorfall informiert haben. Der Käufer ist einverstanden, dass vorliegende Garantie für eine Dauer von 2 Jahren gültig ist. Der Verkäufer haftet im Rahmen dieser Garantie nicht für Defekte, sofern sie Verschleißteile betreffen, sie das Ergebnis vorsätzlicher Beschädigung oder Fahrlässigkeit seitens des Käufers sind oder Schäden darstellen, die aufgrund von unsachgemäßer Bedienung durch den Benutzer entstanden sind, der Käufer physische Veränderungen am Gerät vorgenommen hat, die der Verkäufer nicht erlaubt hat.

Damit der Käufer in den Genuss der Garantieleistungen kommen kann, muss er psmlighting jeden Defekt innerhalb des oben festgelegten Zeitrahmens melden – unter Angabe der Art des Defektes und aller relevanten Informationen.

### ZAHLUNG

Bis zur vollständigen Bezahlung aller Rechnungen, einschließlich Gebühren, Zinsen, Schadenverfahren und eventuellen Steuern, behalten wir uns das alleinige Eigentumsrecht der gelieferten Ware vor, sogar falls diese Ware schon weiterverkauft oder installiert worden ist. Psmlighting wird das Recht eingeräumt, die unbezahlte Ware zurückzufordern, egal wo die sich befindet, ohne Regress des Käufers. Während dieses Zeitraums ist der Käufer gehalten, die Pflichten und Verantwortlichkeiten des

Verwahrers der Ware zu übernehmen und diese in diesem Sinne zu überwachen, versichern gegen Beschädigung, Vernichtung, Diebstahl, Feuer, Verlust, usw.

Vorbehaltlich anderslautender Bestimmung, passiert die Zahlung mit Vorkasse durch Überweisung. Bankgebühren sind zu Lasten des Käufers.

Falls, auf schriftliche Anfrage des Bestellers, die Rechnung auf Namen eines Dritten erstellt wird, bleibt der Besteller jederzeit und unter allen Umständen dem Verkäufer gegenüber persönlich zur Einhaltung der Verpflichtungen verantwortlich, die aus der Vereinbarung und den allgemeinen Bedingungen hervorgehen.

Im Fall der Nichtzahlung am Fälligkeitstag, ist das geschuldete Saldo aller anderen, selbst nicht fälligen Rechnungen von Rechts wegen unverzüglich einklagbar. Psmlighting wird das Recht eingeräumt, die unbezahlte Ware zurückzufordern, egal wo die sich befindet, ohne Regress des Käufers. Im Fall der Nichtzahlung einen Wechsel wird die vollständige Summe aufs neue einklagbar.

Im Falle der Nichtbezahlung der Rechnung am Fälligkeitstag ist der Käufer von Rechtswegen und ohne vorherige Aufforderung zur Zahlung von Verzugszinsen verpflichtet, zum gesetzlichen Zinssatz vom 2. August 2002 zur Bekämpfung von Zahlungsverzug im Geschäftsverkehr berechnet. Die Zinsen sind für jeden ersten Tag des Monats geschuldet. Darüber hinaus werden die nicht gezahlten Beträge mit einer vereinbarten Pauschalentschädigung von 10% des geschuldeten Betrags erhöht, mit einem Mindestbetrag von 65 Euro als Schadenersatz, unbeschadet des Rechts des psmlighting Zahlung der Kosten vom gerichtlichen Mahnverfahren zu fordern, selbst wenn eine Aufschubfrist gewährt wird.

Ständige Nichteinhaltung der vereinbarten Zahlungsbedingungen berechtigt uns, von der Lieferungsverpflichtung zurückzutreten, sogar falls die Lieferung vorher schon verabredet war. Protest gegen die Rechnung muss innerhalb von 8 Tagen nach Rechnungsdatum angemeldet sein. Der Poststempel bestimmt, ob das Protest rechtzeitig erfolgt ist.

### GERRICHTSSTAND

Für alle Vereinbarungen gilt das Belgische Recht, unter Ausschluss des Wiener Kaufvertrages. Im Falle von Streitigkeiten sind ausschließlich die Gerichte des Sitzes der Gesellschaft zuständig.

# Standard

## colours indoor

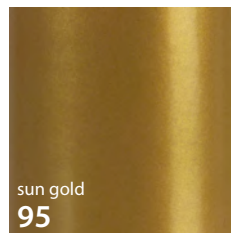
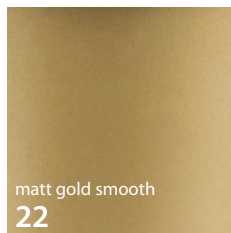
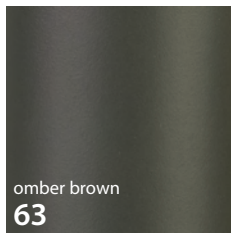
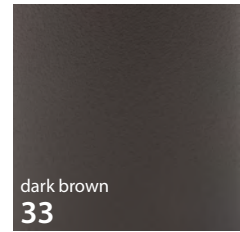
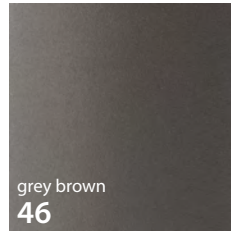
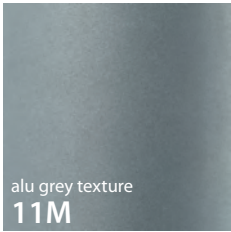
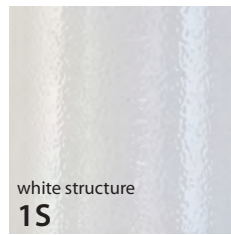

# Natural

## colours indoor

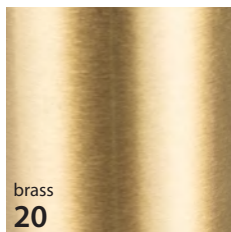

# Matt colours indoor

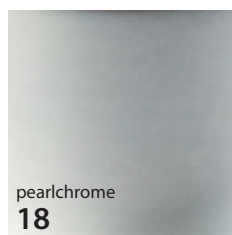
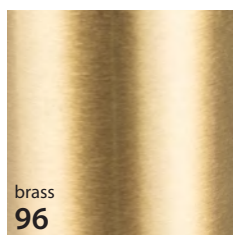

# Satin colours indoor

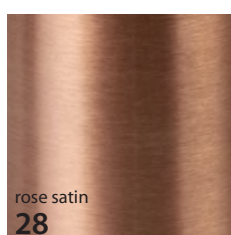
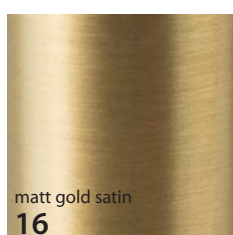

# Gloss colours indoor

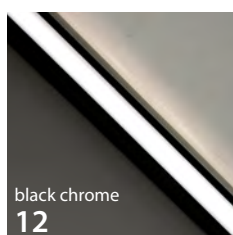
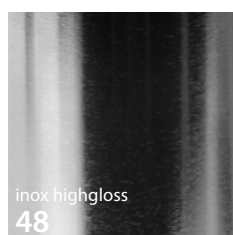
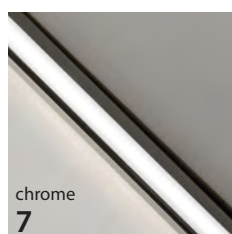
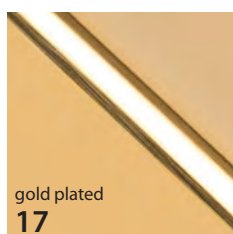
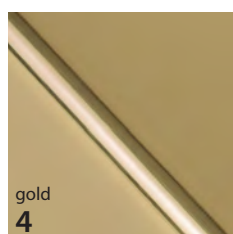



# Wetlack colours indoor

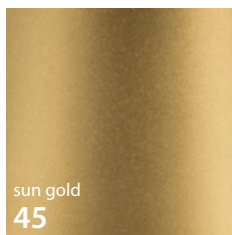

# Pastel colours indoor

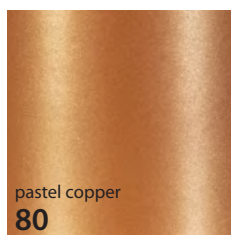
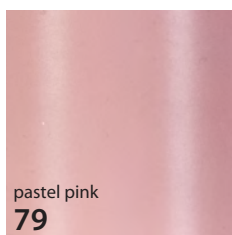

# Combi colours indoor

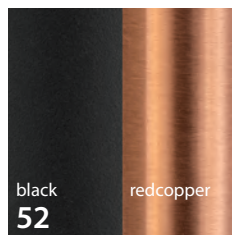
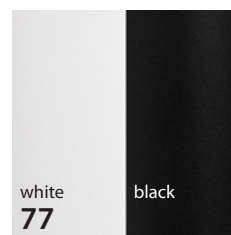
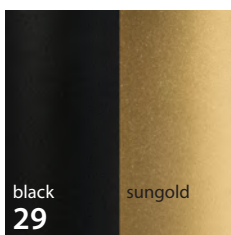

# Anodised colours indoor

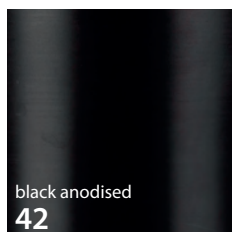
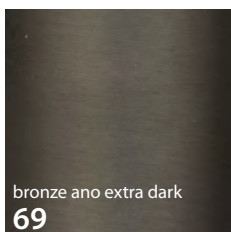
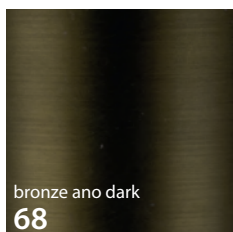
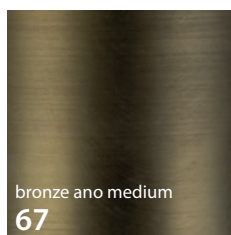
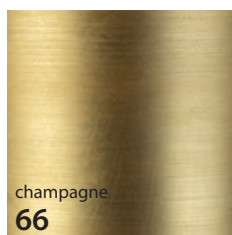
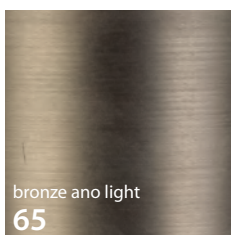

# Bronze colours indoor

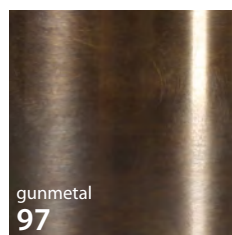
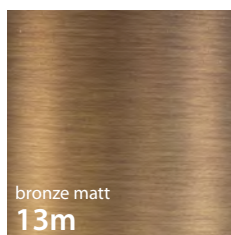
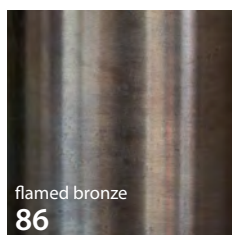
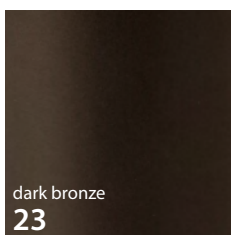
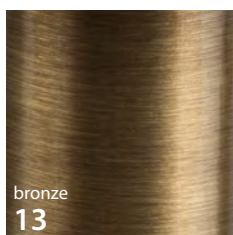

# Glass colours indoor



# Shake Combi

colours indoor



# Cameleon Combi

colours indoor

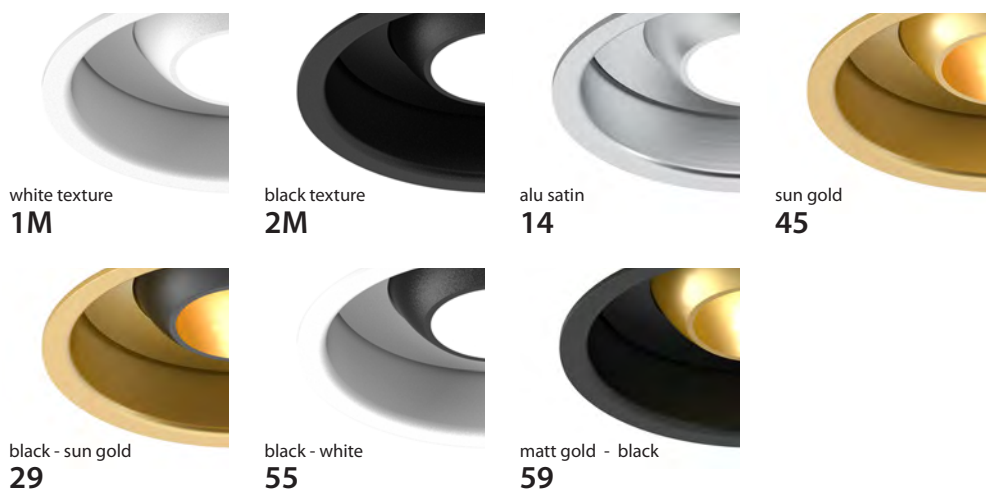

# Jacob colours indoor

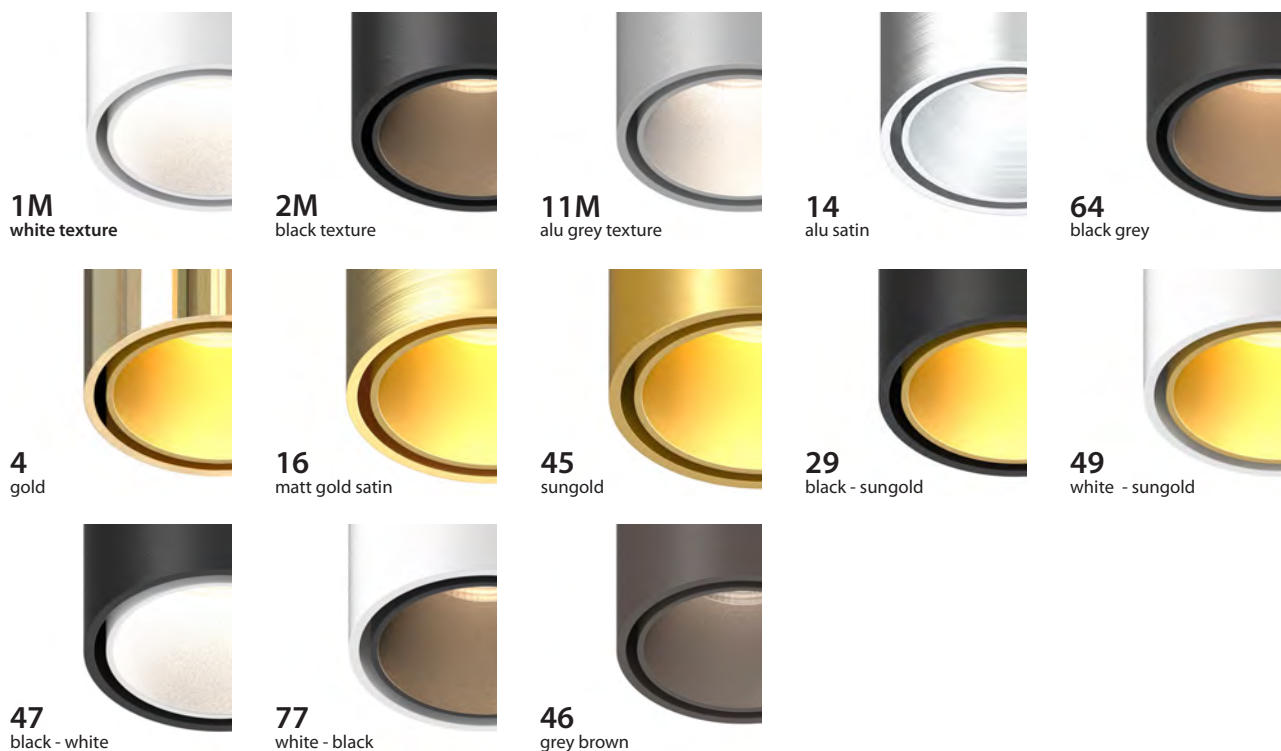

Psmighting offers you a big range of different colours.

In our own paintshop, we paint the products carefully and with high quality powder coatings. The big advantage of our own paintshop is the shorter delivery time for our standard colours and products.

**Please note: the colours in this folder can differ from the real colours.**



CODE	KLEUR	COLEUR	COLOUR	FABRE	MATERIAL	RAL COLOUR CODE
1	wit	blanc	white	Weiß	aluminium	
1M	wit textuur	blanc mat texture	white tex	matt Weiß textur	aluminium	RAL 9016
1MA	wit textuur ano	blanc mat texture ano	white tex ano	matt Weiß textur ano	ALU ANODISE	
1S	wit structuur ano	blanc structure IP44	white structure IP44	Struktur Weiß IP44	aluminium	RAL 9003
2	zwart	noir	black	Schwarz	aluminium	
2M	zwart textuur	noir texture	black tex	Schwarz textur	aluminium	RAL 9005
2MA	zwart textuur ano	noir texture ano	black tex ano	Schwarz textur ano	ALU ANODISE	RAL 9005
4	blinkend goud	or brillant	shiny gold	glänzend Gold	messing	
5	INOX 316	inox 316	inox 316	Edelstahl 316	INOX 316	
5B	inox 316 1x beh.	inox 316 traité	inox 316 1x coated	Edelstahl 316 behandelt	INOX 316	
5BB	inox 316 2x beh.	inox 316 double traité	inox 316 2x coated	Edelstahl 316 doppelt behandelt	INOX 316	
7	chrom	chrome	chrome	Chrom	messing	
10	alu grijs NL	alu gris (laqué)	alu grey	Alu Grau (lackiert)	aluminium	RAL 9006 bij benadering
11	metaalgrijs	gris métal	alu grey	Metallgrau	aluminium	RAL 9007
11M	grijs textuur	gris texture	grey tex	Grau textur	aluminium	
11MA	grijs textuur ano	gris texture ano	grey tex ano	Grau textur ano	ALU ANODISE	
12	zwart chrom	chrome noire	black chrome	Schwarz Chrom	messing	
13	brons	bronze	bronze	Bronze	messing	
14	alu satijn	alu satiné	alu satin	Alu satiniert	aluminium	Niet geschikt voor badkamers of vochtige ruimtes
16	goud satijn	laiton satin	satin gold	Satin Gold	messing	
20	bruut messing	laiton brut	raw brass	rohes Messing	messing	
21	donker roest	rouille	rust	Rost	aluminium	
22	mat goud	laiton brossé (laqué)	matt gold	matt Gold (Lackiert)	aluminium	
23	donker brons	bronze foncé (antique)	dark bronze	dunkelbronze (antik)	messing	
24	gezandstraald alu	alu sablé	alu sandblasted	gesandstrahltes Alu	aluminium	
28	rosé	rosé	rosé	rosé	rood koper	
30	rood koper	cuivre rouge	red copper	rotes Kupfer	rood koper	
31MA	wit textuur	blanc mat texture	white texture	mat weiß textur	ALU / INOX / BRASS	
32	zwart textuur	noir texture	black texture	Schwarz textur	inox	
33M	bruin textuur	brun texture	brown texture	braun struktur	inox	RAL 8019
35A	donkergrijs structuur	gris foncé structure	dark grey structured	dunkel Grau struktur	ALU ANODISE	RAL 7021 = bruiner van tint
36	alu grijs natlak	alu gris	alu grey	Alu Grau	ALU ANODISE	
37	grijs textuur	gris texture	grey texture	Grau textur	inox	
38	blauwsteen	pierre bleu	blue stone	Blaustein	arduin	
40	alu geanodiseerd	aluminium anodisé	anodised alu	anodisiertes Alu	ALU ANODISE	WIT SAT 15 MICRON
44	antraciet grijs	gris anthracite texture	anthracite grey texture	Anthrazitgrau textur	ALU ANODISE	RAL 7016 TEXTUUR
46	grijs-bruin	gris-brun	grey-brown	Grau-Braun	inox	bij benadering RAL 7039
47	zwart - wit in	noir - blanc int.	black - white in	Schwarz - Weiß IN	aluminium	
48	inox hoogglans	inox haut brillant	inox high gloss	Hochglänzend Edelstahl	inox	
50	mat chrom (buitengebruik)	chrome mat (usage extérieur)	matt chrome (outdoor use)	Matt Chrom (aussengebrauch)	messing	
53	brons-bruin	brun-bronze	bronze-brown	Bronze-Braun	inox	
54	cortenstaal	acier corten	corten steel	Cortenstahl	Cortenstaal	
55	wit out - bol zwart	blanc ext. - boule noir	white out - ball black	Weiß out - Kugel schwarz	aluminium	
56	roodkoper blink	cuivre rouge brillant	red copper shiny	Rotes Kupfer Glanz	rood koper	
59	zwart out - bol goud	noir ext. - boule or	black out - ball gold	Schwarz out - Kugel Gold	aluminium	
58	wit out - RK in	blanc ext. - CR int.	white out - RC in	Weiss out - RK in	aluminium / roodkoper	
60	verkoperen	cuivrage	copper plating	Verkupferung	inox	
63	ombergrijs	umbra gris	umbra grey	umbra Grau	aluminium	RAL 7022
64	zwartgrijs	grisnoir	black grey	Schwarzgrau	aluminium	RAL 7021
95	zonnegoud	or dorée	sun gold	Sonnengold	aluminium	
153	donker brons-bruin	bronze foncé - brun	dark bronze - brown	Dunkel Bronze - Braun	aluminium	

CODE	KLEUR	COLEUR	COLOUR	FABRE AUßEN	MATERIAL	RAL COLOUR CODE
29	zwart - goud in	noir - dorée int.	black - gold in	Schwarz - Gold IN	aluminium	
77	wit - zwart in	blanc - noir int.	white - black in	Weiß - Schwarz IN	aluminium	
49	wit - goud in	blanc - dorée int.	white - gold in	Weiß - Gold IN	aluminium	
52	zwart out - RK in	noir ext. - CR int.	black out - RC in	Schwarz out - RK in	rood koper	
116	wit - goud	blanc - or	white - gold	Weiß - Gold	aluminium / messing	
128	wit - RK	blanc - CR	white - RC	Weiß - RK	aluminium / roodkoper	
141	alu - wit	alu - blanc	alu - white	Alu - weiß	aluminium	
142	alu - zwart	alu - noir	alu - black	Alu - schwarz	aluminium	
161	goud - wit	blanc - or	white - gold	Weiß - Gold	aluminium / messing	
162	goud - zwart	noir - or	black - gold	Schwarz - Gold	aluminium / messing	
216	zwart - goud	noir - or	black - gold	Schwarz - Gold	aluminium / messing	
228	zwart - rood koper	noir - CR	black - RC	Schwarz - RK	aluminium / roodkoper	
281	RK - wit	CR - blanc	RC - white	RK - Weiß	aluminium / roodkoper	
282	RK - zwart	CR - noir	RC - black	RK - Schwarz	aluminium / roodkoper	
MIX16	mix goud - zwart	mix or - noir	mix gold - black	Mix Gold - Schwarz	aluminium / messing	
MIX28	mix RK - zwart	mix CR - noir	mix RC - black	mix RK - Schwarz	aluminium / roodkoper	
COMBI	combi	combi	combi	combi	aluminium	
74	noble brons	noble bronze	noble bronze	Noble Bronze	aluminium	
78	pastel blauw	bleu pastel	pastel blue	Pastellblau	aluminium	RAL 5024
79	pastel roze	rose pastel	pastel pink	Pastellrosa	aluminium	RAL 3015
80	pastel koper	cuivre pastel	pastel copper	Pastellkupfer	aluminium	
81	pastel groen	vert pastel	pastel green	Pastellgrün	aluminium	RAL 6021
93	brons-bruin	brun-bronze	bronze-brown	Bronze-Braun	aluminium	RAL 7013
84	copper metallic	cuivre métallique	copper metallic	kupfermetallic	aluminium	059/92780
86	gevlamd brons	bronze flammé	flame bronze	geflamte Bronze	messing	donker brons
82	pastel creme	crème pastel	pastel cream	Pastellcreme	aluminium	RAL 1015
ALU	aluminium	aluminium	aluminium	Aluminium		
MESS	Messing	laiton	brass	Messing		
INOX	inox	Inox	stainless steel	Edelstahl		

Andere kleuren op aanvraag - Autres couleurs sur demande - Other colours on request - Andere Farben auf Anfrage erhältlich

CODE	KLEUR BUITEN	COLEUR EXTÉRIEUR	COLOUR OUTDOOR	FABRE AUßEN	MATERIAL	RAL COLOUR CODE
29	zwart - goud in	noir - dorée int.	black - gold in	Schwarz - Gold IN	aluminium	
77	wit - zwart in	blanc - noir int.	white - black in	Weiß - Schwarz IN	aluminium	
49	wit - goud in	blanc - dorée int.	white - gold in	Weiß - Gold IN	aluminium	
52	zwart out - RK in	noir ext. - CR int.	black out - RC in	Schwarz out - RK in	rood koper	
116	wit - goud	blanc - or	white - gold	Weiß - Gold	aluminium / messing	
128	wit - RK	blanc - CR	white - RC	Weiß - RK	aluminium / roodkoper	
141	alu - wit	alu - blanc	alu - white	Alu - weiß	aluminium	
142	alu - zwart	alu - noir	alu - black	Alu - schwarz	aluminium	
161	goud - wit	blanc - or	white - gold	Weiß - Gold	aluminium / messing	
162	goud - zwart	noir - or	black - gold	Schwarz - Gold	aluminium / messing	
216	zwart - goud	noir - or	black - gold	Schwarz - Gold	aluminium / messing	
228	zwart - rood koper	noir - CR	black - RC	Schwarz - RK	aluminium / roodkoper	
281	RK - wit	CR - blanc	RC - white	RK - Weiß	aluminium / roodkoper	
282	RK - zwart	CR - noir	RC - black	RK - Schwarz	aluminium / roodkoper	
MIX16	mix goud - zwart	mix or - noir	mix gold - black	Mix Gold - Schwarz	aluminium / messing	
MIX28	mix RK - zwart	mix CR - noir	mix RC - black	mix RK - Schwarz	aluminium / roodkoper	
COMBI	combi	combi	combi	combi	aluminium	
74	noble brons	noble bronze	noble bronze	Noble Bronze	aluminium	
78	pastel blauw	bleu pastel	pastel blue	Pastellblau	aluminium	RAL 5024
79	pastel roze	rose pastel	pastel pink	Pastellrosa	aluminium	RAL 3015
80	pastel koper	cuivre pastel	pastel copper	Pastellkupfer	aluminium	
81	pastel groen	vert pastel	pastel green	Pastellgrün	aluminium	RAL 6021
93	brons-bruin	brun-bronze	bronze-brown	Bronze-Braun	aluminium	RAL 7013
84	copper metallic	cuivre métallique	copper metallic	kupfermetallic	aluminium	059/92780
86	gevlamd brons	bronze flammé	flame bronze	geflamte Bronze	messing	donker brons
82	pastel creme	crème pastel	pastel cream	Pastellcreme	aluminium	RAL 1015
ALU	aluminium	aluminium	aluminium	Aluminium		
MESS	Messing	laiton	brass	Messing		
INOX	inox	Inox	stainless steel	Edelstahl		

ELEKTRISCHE GEGEVENS	SPÉCIFICATION ELECTRIQUE	ELECTRICAL SPECIFICATION	ELEKTRISCHE DATEN
MAX. WATTAGE	MAX. PUISSANCE EN WATTS	MAX. WATTAGE	MAX. WATTLLEISTUNG
LAMP TYPE	TYPE DE LAMPE	TYPE OF LAMP	LAMPENTYP
WISSELSTROOM AC	COURANT ALTERNATIF AC	ALTERNATING CURRENT AC	WECHSELSTROM WS
GELIJKSTROOM DC	COURANT CONTINU DC	DIRECT CURRENT DC	GLEICHSTROM GS
MET TRANSFO	AVEC TRANSFO	WITH TRANSFORMER	MIT TRAFO
ZONDER TRANSFO	SANS TRANSFO	WITHOUT TRANSFORMER	OHNE TRAFO
ZONDER BALLAST	SANS BALLAST	WITHOUT BALLAST	OHNE VORSCHALTGERÄT
MAGNETISCHE VOORSCHAKELAPPARATUUR	BALLAST FERROMAGNÉTIQUE	MAGNETIC BALLAST	KONVENTIONELLES VORSCHALTGERÄT
ELEKTRONISCHE VOORSCHAKELAPPARATUUR	BALLAST ÉLECTRONIQUE	ELECTRONIC BALLAST	ELEKTRONISCHES VORSCHALTGERÄT
DIMBAAR ELEKTRONISCHE VOORSCHAKELAPPARATUUR	BALLAST ÉLECTRONIQUE DIMMABLE	DIMMABLE ELECTRONIC BALLAST	ELEKTRONISCHES ABLENDBARES VORSCHALTGERÄT
MET LED DRIVER	AVEC DRIVER LED	WITH LED DRIVER	MIT LED DRIVER
ZONDER LED DRIVER	SANS DRIVER LED	WITHOUT LED DRIVER	OHNE LED DRIVER
TOESTEL KLASSE I - MET AARDING	APPAREIL CLASSE I - MIS À LA TERRE	FIXTURE CLASS I - WITH EARTHING	GERÄT KLASSE I - MIT ERDUNG
TOESTEL KLASSE II	APPAREIL CLASSE II	FIXTURE CLASS II	GERÄT KLASSE II
TOESTEL KLASSE III	APPAREIL CLASSE III	FIXTURE CLASS III	GERÄT KLASSE III
NORM	NORME	STANDARD	NORM
MIN. AFSTAND (M) LAMP-OBJECT	DISTANCE MIN. (M) AMPOULE-OBJET	MIN. DISTANCE (M) LAMP-OBJECT	MIN. DISTANZ (M) LEUCHE-OBJEKT
LAMPHOUDER MAX. 90° DRAAIEN	NE TOURNEZ SOCQUET QUE 90° MAX.	DON'T TURN LAMPHOLDER MORE THAN 90° MAX.	FASSUNG NICHT MEHR ALS 90° MAX. DREHEN
ECO LAMP	AMPOULE ECO	ECO LAMP	ECO LAMPE

MECHANISCHE GEGEVENS	SPECIFICATION MÉCANIQUE	MECHANICAL SPECIFICATION	MECHANISCHE DATEN
AFMETINGEN ARMATUUR IN MM	DIMENSIONS DU LUMINAIRE EN MM	DIMENSIONS OF LUMINAIRE IN MM	ABMESSUNGEN DER LEUCHE IN MM
INBOUWDIEPTE	PROFONDEUR D'ENCASTREMENT	BUILD-IN DEPTH	EINBAUTIEFE
INBOUWMATEN ROND	DIMENSIONS D'ENCASTREMENT RONDES	APERTURE DIMENSIONS ROUND	EINBAUMAË RUND
INBOUWMATEN VIERKANT-RECHTHOEGIG	DIMENSIONS D'ENCASTREMENT CARRÉES-RECTANGULAIRES	APERTURE DIMENSIONS SQUARE-RECTANGULAR	EINBAUMAË VIERECKIG-RECHTECKIG
CENTERAFSTAND	ENTRES-AXES	CENTERDISTANCE	ACHSABSTAND
BOORMATEN OPBOUW	DIMENSIONS DE PERÇAGE APPARENTES	SURFACE-MOUNTED FIXTURE DIMENSIONS	BEFESTIGUNGSMAË FÜR AUFBAU
OPHANGING (IN METER)	SUSPENSION (EN M)	SUSPENSION (IN METER)	AUFHÄNGUNG (PER METER)
REFLECTOR	RÉFLECTEUR	REFLECTOR	REFLEKTOR
GLASDIKTE	ÉPAISSEUR DU VERRE	GLASS THICKNESS	GLASDICKE
HORIZONTALE RICHTBAARHEID	ORIENTABLE HORIZONTALEMENT	DIRECTIONAL IN HORIZONTAL PLANE	SCHWENKBAR IN HORIZONTALER RICHTUNG
VERTICALE RICHTBAARHEID	ORIENTABLE VERTICALEMENT	DIRECTIONAL IN VERTICAL PLANE	SCHWENKBAR IN VERTIKALER RICHTUNG
ZOWEL VERTICALE ALS HORIZONTALE RICHTBAARHEID	ORIENTABLE EN DIRECTION VERTICALE ET HORIZONTALE	DIRECTIONAL IN VERTICAL AND HORIZONTAL PLANE	SCHWENKBAR IN VERTIKALER UND HORIZONTALER RICHTUNG
S0 ZONDER VEREN	SANS RESSORTS	WITHOUT SPRINGS	OHNE FEDERN
S1 MET SPRINGVEREN	AVEC DES RESSORTS À TORSION	WITH TORSION SPRINGS	MIT TORSIONSFEDERN
S2 MET BLADVEREN	AVEC DES RESSORTS À LAMELLES	WITH FLAT SPRINGS	MIT BLATTFEDERN
S3 U-BEUGEL + SPRINGVEREN	U-SUPPORT + RESSORTS À TORSION	U SUPPORT + TORSION SPINGS	U-BÜGEL + TORSIONSFEDERN
S4 SCHUIFKLEM	CLIP COULLISSANT	SLIDING CLIP	SCHIEBEKLEMME
GEWICHT KG	POIDS KG	WEIGHT KG	GEWICHT KG

TOEPASSING	APPLICATION	APPLICATION	ANWENDUNG
BINNENGEBRUIK	USAGE À L'INTÉRIEUR	INDOOR USE	INNENGEBRAUCH
BUITENGEBRUIK	USAGE À L'EXTÉRIEUR	OUTDOOR USE	AUßENGEBRAUCH
ZOWEL BINNEN- ALS BUITENGEBRUIK	USAGE TANT À L'INTÉRIEUR QU'À L'EXTÉRIEUR	BOTH INDOOR AND OUTDOOR USE	INNEN- ALS AUßENGEBRAUCH
BESCHERMINGSINDICATIE	INDICE DE PROTECTION	PROTECTION LEVEL	SCHUTZKENNZIFFER
PLAFONDBEVESTIGING	MONTAGE AU PLAFOND	FIXATION CEILING	DECKENMONTAGE
WANDBEVESTIGING	MONTAGE AU MUR	FIXATION WALL	WANDMONTAGE
VLOERBEVESTIGING	MONTAGE AU SOL	FIXATION FLOOR	BODENMONTAGE
STAND ALONE	STAND ALONE	STAND ALONE	STAND ALONE
PLAFOND- OF WANDBEVESTIGING	MONTAGE AU PLAFOND OU AU MUR	FIXATION CEILING OR WALL	DECKEN- ODER WANDMONTAGE
VLOER- OF WANDBEVESTIGING	MONTAGE AU SOL OU AU MUR	FIXATION FLOOR OR WALL	BODEN- ODER WANDMONTAGE
VLOER, PLAFOND- OF WANDBEVESTIGING	MONTAGE AU SOL, PLAFOND OU AU MUR	FIXATION FLOOR, CEILING OR WALL	BODEN-, DECKEN- ODER WANDMONTAGE
MONTAGE TOEGELATEN BIJ ONBEKENDE ONTVLAMBAAARHEID VAN MATERIAAL	MONTAGE PERMIS EN CAS D'INFLAMMABILITÉ DES MATIÈRES INCONNUES	ASSEMBLY PERMITTED IN CASE OF UNKNOWN FLAMMABILITY OF MATERIALS	MONTAGE ERLAUBT BEI UNBEKANNTER ENTZÜNDBARKEIT DES MATERIALS



## LED ( Light Emitting Diode)

SYMBOL	CODE	LAMPHOLDER	POWER	VOLTAGE	RECUPEL
	powerled 350mA	Powerled	2X1	500mA	05.20.50
	powerled 700mA	Powerled	3	700mA	05.20.50
	Led 230V	SMD led	4	230V-240V/50Hz	05.20.50
	Led 24V-DC	SMD led	4	24V-DC	05.20.50
	XTM.19	Ledmodule	9.5	700mA	05.20.50
	XSM	Ledmodule	8.8	700mA	05.20.50
	LUT33	Ledmodule	13	230V-240V/50Hz	05.20.50
	CLARA	Ledmodule	6	230V-240V/50Hz	05.20.50
	SLA AC	Ledmodule	9.5	230V-240V/50Hz	05.20.50
	SLA DC	Ledmodule	8.8	350mA	05.20.50

*Om producttechnische redenen kunnen LEDs in koud witte CW, naturel witte NW en warm witte WW kleur kleine verschillen tonen in kleurtemperatuur. Wij proberen daarom per bestelling uit één productie te leveren. Bij nabestellingen is het moeilijk diezelfde kleurtint te garanderen.*

*Due to product-technical reasons it is possible that LEDs in cold white CW, natural white NW and warm white WW show a difference in colour temperature. That is why psmighting tries to deliver the LEDs from 1 batch for 1 order. For additional orders it is impossible to guarantee the same colour temperature.*

*We raden aan om voldoende airflow rond te lamp te voorzien. Zorg er dus voor dat de lamp niet te ingesloten zit in het plafond, de wand of de vloer zodat de lamp niet te warm kan krijgen. Hoe minder ruimte rond de lamp, hoe korter de levensduur.*

*We recommend to provide sufficient airflow around the lamp. Make sure that the lamp is not too enclosed in the ceiling, wall or floor so that the lamp cannot get too hot. The less space around the lamp, the shorter its lifespan.*

*Nous recommandons de prévoir un flux d'air suffisant autour de la lampe. Assurez-vous que la lampe n'est pas trop enfermée dans le plafond, le mur ou le sol afin qu'elle ne soit pas trop chaude. Moins il y a d'espace autour de la lampe, plus sa durée de vie est courte.*

*Wir empfehlen, für einen ausreichenden Luftstrom um die Lampe zu sorgen. Achten Sie darauf, dass die Lampe nicht zu sehr in der Decke, der Wand oder dem Boden eingeschlossen ist, damit die Lampe nicht zu heiß werden kann. Je weniger Platz um die Lampe herum ist, desto kürzer ist ihre Lebensdauer.*

*Wattage aan te passen aan het type plafond ( beton, hout,pvc, enz...)  
Adjust the wattage to the type of ceiling (concrete,wood,PVC, etc...)  
Adaptez la puissance selon le type de plafond (béton, bois, PVC,...)  
Leistung (Watt) auf den Typ der Decke abstimmen (Beton, Holz, PVC,...)*

**Alle gegevens zijn richtwaarden. Bindend zijn alleen de meest actuele gegevens van de lampenfabrikanten. Lampen met grotere lengten of afwijkende sokkels, kunnen in sommige armaturen niet gebruikt worden.**











**Toutes les données sont indicatives. Seulement les données actuelles des fabricants de lampes sont contraignantes. Des lampes avec d'autres longueurs ou des douilles différentes ne peuvent pas être utilisées dans certaines armatures.**

**All data are indicative. Only the most current data from lamp-manufacturers are binding. Lamps with other dimensions or different lampholders cannot be used in certain light fittings.**







**Alle Daten sind indikativ. Nur die meist aktuellen Daten von Leuchtmittelherstellern sind verbindlich. Leuchtmittel mit größeren Längen oder abweichenden**

**Fassungen dürfen in einiger Leuchten nicht verwendet werden.**





## Reflector led lamps (retrofit)

SYMBOL	CODE	LAMPHOLDER	POWER	VOLTAGE	RECUPEL
	QR-CB 35	GU4/GZ4	4	12V	05.20.02
	QR-CB 51	GU5,3/GX5,3	9	12V	05.20.02
	QPAR 51	GU10	8	24V-DC	05.20.02
	QPAR64	GU10	8	230V-240V/50Hz	05.20.02
	QPAR62	GU10	8	230V-240V/50Hz	05.20.02
	QPAR70	GU10	8	230V-240V/50Hz	05.20.02
	QR-LP111	G53	12	36V-DC	05.20.02
	QPAR111	GU10	12	230V-240V/50Hz	05.20.02
	R63	E27	7.5	230V-240V/50Hz	05.20.02
	QPAR 20	E27	10	230V-240V/50Hz	05.20.02
	QPAR 30	E27	10	230V-240V/50Hz	05.20.02



## Filament led lamps (retrofit)

SYMBOL	CODE	LAMPHOLDER	POWER	VOLTAGE	RECUPEL
	C35	E14	9	230V-240V/50Hz	05.20.02
	D45	E14	9	230V-240V/50Hz	05.20.02
	A60	E27	8	230V-240V/50Hz	05.20.02
	ST64	E27	8	230V-240V/50Hz	05.20.02
	G80	E27	6	230V-240V/50Hz	05.20.02
	G95	E27	6	230V-240V/50Hz	05.20.02

## Other led Lamps (retrofit)

SYMBOL	CODE	LAMPHOLDER	POWER	VOLTAGE	RECUPEL
	QT14	G9	7	230V-240V/50Hz	05.20.02
	TCR-TSE	GX53	9	230V-240V/50Hz	05.20.02
	IT-	E27	8	230V-240V/50Hz	05.20.02
	TC-L	2G11	55	230V-240V/50Hz	05.20.05
	TC-DEL	G24Q-3	26	230V-240V/50Hz	05.20.05

## Fluorescent Lamps

SYMBOL	CODE	LAMPHOLDER	POWER	VOLTAGE	RECUPEL
	T16FQT5	G5	24-54	230V-240V/50Hz	05.20.05
	T16FHT5	G5	14-35	230V-240V/50Hz	05.20.05

<b>DRIVER CONSTANT VOLTAGE (MAX. 70W -24V-DC)</b>				
DISTANCE	5 m	10 m	20 m	30 m
CABLE SECTIE	0,75 mm <sup>2</sup>	1 mm <sup>2</sup>	1,5 mm <sup>2</sup>	2,5 mm <sup>2</sup>
<b>DRIVER CONSTANT VOLTAGE (MAX. 150W -24V-DC/ 70W 12V)</b>				
DISTANCE	5 m	10 m	20 m	30 m
CABLE SECTIE	1,5 mm <sup>2</sup>	2,5 mm <sup>2</sup>	4 mm <sup>2</sup>	4 mm <sup>2</sup>
<b>DRIVER CONSTANT CURRENT (350mA - 500mA)</b>				
DISTANCE	5 m	10 m	20 m	50 m
CABLE SECTIE	0,25 mm <sup>2</sup>	0,25 mm <sup>2</sup>	0,5 mm <sup>2</sup>	1 mm <sup>2</sup>
<b>DRIVER CONSTANT CURRENT (700mA - 1A)</b>				
DISTANCE	5 m	10 m	20 m	50 m
CABLE SECTIE	0,5 mm <sup>2</sup>	0,5 mm <sup>2</sup>	1 mm <sup>2</sup>	2,5 mm <sup>2</sup>
<b>DRIVER CONSTANT CURRENT (1,2A - 2A)</b>				
DISTANCE	5 m	10 m	20 m	30 m
CABLE SECTIE	0,75 mm <sup>2</sup>	1 mm <sup>2</sup>	1,5 mm <sup>2</sup>	2,5 mm <sup>2</sup>
<b>DRIVER CONSTANT CURRENT (350mA - 500mA)</b>				
DISTANCE	5 m	10 m	15 m	-
CABLE SECTIE	0,25 mm <sup>2</sup>	0,25 mm <sup>2</sup>	0,5 mm <sup>2</sup>	-
<b>DIMMABLE DRIVER (700mA - 1A)</b>				
DISTANCE	5 m	10 m	15 m	-
CABLE SECTIE	0,5 mm <sup>2</sup>	0,5 mm <sup>2</sup>	1 mm <sup>2</sup>	-
<b>DIMMABLE DRIVER (1,2A - 2A)</b>				
DISTANCE	5 m	10 m	15 m	-
CABLE SECTIE	1 mm <sup>2</sup>	1 mm <sup>2</sup>	2,5 mm <sup>2</sup>	-

# Index

## Symbolen

000B3/..	74-84	050/..	59	161.10/..	32	704.1400X300/..	90	953/..	436-648
000C/..	43/111	50.10/..	38	162.10/..	33	705.1200X500/..	90	954/..	436-648
000CR/..	42/111	053/..	58	181.10/..	32	752.220/..	97	955/..	436-648
001/..	56	054B/..	50-287	182.10/..	34	753.220/..	98	956/..	436-648
002/..	30	056/..	44	280.LED/..	507	807.ZT/..	81	962/..	72
003/..	56	057/..	50	541.SEN/..	448	808.ZT/..	80	963/..	72
003.NCS/..	20	058/..	51	616.AR70.45/..	430	809.ZT/..	81	964/..	72
003.RALSTOCK/..	20	059/..	52	616.ES50.45/..	428	811/..	82	965/..	72
004/..	56	60./..	152-167	617.AR70.45/..	430	814/..	83	966/..	74
005/..	56	60.10/..	38	617.ES50.45/..	428	817.ZT/..	81	973.ES50/..	435
006/..	63	060.B3.D8,3/..	60	618.AR70.45/..	430	818/..	82	978/..	427
013/..	30	060.B3.D12/..	60	618.ES50.45/..	429	821.ZT/..	68	978T/..	696
014/..	30	61./..	169	619.AR70.45/..	430	822.ZT/..	68	979/..	427
015/./..	46	061/..	58	619.ES50.45/..	429	823/..	70	981/..	427
017/..	64	61.10/..	30	620.AR70.45/..	431	824/..	70	982/..	427
019/..	46	62./..	162	620.ES50.45/..	429	856/..	102	983/..	428
020/..	28-57	062/..	67	621.AR70/..	425	858ZT/..	102	984/..	428
020.B3/./..	61-291	63./..	152-168	621.ES50/..	424	860ZT/..	102	990././..	684
021.B3/..	61	063/..	67	622.AR70/..	425	896.A.ZT/..	102	990A././..	684
021.ZT/..	57	64./..	161	622.ES50/..	424	897A.ZT/..	103	990B././..	686
022/..	46-86	064/..	66	623.AR70/..	425	898.A.ZT/..	103	990X/..	683
023	47	065././..	35	623.ES50/..	424	899.A.ZT/..	103	990XA/..	683
024/..	47-57-86	065.65/./..	40	624.AR70/..	426	900.A.ZT/..	103	991.A.E27D140/..	670
025/..	57-64	066/..	66	624.ES50/..	424	901.A/..	104	991.B.E27D180/..	670
025.B3/./..	65	067/..	66	625.AR70/..	425	911/..	432	991.C.E27D250/..	670
026.ZT/..	64	68./..	169	640.200.LED/..	454	912/..	432	995/..	433
027/..	64	068/..	66	640.300.LED/..	454	913/..	432	996/..	433
028/..	63	69./..	168	640.400.LED/..	454	914/..	432	997/..	433
28..LED/..	507	069/..	67	641.HL/..	622	923.ZT/..	68	998/..	433
030/..	63	70./..	164	641.SL/..	455-623	924A/..	70	999././..	685
032/..	59	070/..	67	641.VL/..	624	924B/..	70	999A././..	685
033.B3.D8,3/..	60-291	71./..	153-170	642.LED/..	448	925C.ZT/..	69	999B././..	686
033.B3.D12/..	60	071/..	54	650/..	91	925D.ZT/..	69	999C././..	686
034.B3/..	61	72./..	170	651/..	91	926C/..	71	999X/..	683
035/..	62	072/..	54	652/..	91	926D/..	71	1046.CAPA/..	576
037B3/..	62	073/..	54-55	653/..	91	927/..	75	1046.CAPAX/..	576
40.10/..	38	80./..	166	654/..	92	928/..	75	1046.JACOB/..	576
042/..	28-58	080././..	35	655/..	93	929/..	75	1046.VOLTA/..	576
043/..	59	80.10/..	38	656/..	93	930/..	75	1047/..	577
044.MA/..	105	080.80/./..	40	657/..	93	932.220/..	96	1048/..	560
045.MA/..	106	81.10/..	31	658/..	93	934.220/..	96	1049/..	560
046.MA/..	107	90./..	164	659/..	94	936.220/..	96	1062/..	560
047.MA/..	108	100././..	36	700/..	94	938.220/..	96	1064/..	562
048.MA/..	109	100.10/..	39	701.900/..	88	940.220/..	97	1066/..	562
049/..	58	100.100/./..	41	701.1200/..	88	942.220/..	97	1067/..	562
		101.10/..	31	701.1600/..	88	944.220/..	97	1068/..	562
		102.10/..	33	701.1800/..	88	945.MT/..	442	1069/..	44
		121.10/..	31	702.1200x160/..	89	946.MT/..	442	1089.300/..	570
		122.10/..	33	703.1200x250/..	89	947/..	442	1093.300/..	568
		141.10/..	31	704.800X300/..	90	947B/..	443	1106L/..	664
		142.10/..	33	704.1200X300/..	90	949/..	442	1106R/..	664



1107L/..	665	1394/..	309	1494/..	162	1733.CEN.3/..	410	1805.E273/..	319
1107R/..	665	1395/..	309	1496/..	481	1735.CEN.5/..	410	1806/..	317
1108.300/..	567	1396/..	309	1498/..	481	1737.CEN.7/..	410	1807B2.E27/..	317
1116.300/..	570	1397/..	310	1500LED/..	628	1741/..	696	1807B3.E27/..	317
1126.300/..	572	1398/..	310	15075.E27/..	272	1743.AS.3/..	406	1809/./..	163
1127.300/..	572	1399/..	310	1508/..	274	1743.CEN.3/..	406	1811/..	385
1128.300/..	570	1400LED/..	615	1509/..	274	1744.CEN.3/..	406	1811.E27/..	382
1131.300/..	567	1401LED/..	615	1510.ZXO/..	362	1745.AS.5/..	408	1812/..	385
1132/..	668	1402LED/..	615	1511.ZXO/..	362	1745.CEN.5/..	408	1812.E27/..	382
1144/..	65	1409/..	204	1512/..	272	1746.CEN.5/..	406	1813/..	385
1162.200/..	79	1410/..	204	1513/..	272	1747.AS.7/..	408	1813.E27/..	382
1162.320/..	79	1412/..	437	1514/..	273	1747.CEN.7/..	408	1814/..	385
1162.400/..	79	1413/..	437	1515/..	273	1749.AS.9/..	409	1814.E27/..	382
1166.200/..	78	1414/..	437	1516/..	673	1749.CEN.9/..	409	1815/..	386
1166.320/..	78	1415LED/..	438	1517B.E27/..	673	1750.ES50/..	610	1815.E27/..	384
1166.400/..	78	1416LED/..	438	1518/..	76	1750.ES63/..	610	1816/..	386
1167.300/..	566	1417/..	204	1519/..	307	1751.ES50/..	610	1816.E27/..	384
1173.300/..	568	1418/..	204	1523/..	307	1752.ES50/..	610	1817B1/..	318
1174.300/..	571	1419W/..	413-620	1525/..	307	1753.ES50/..	612	1817B3/..	318
1175.300/..	571	1422/..	310	1534.300/..	569	1754.ES50/..	611	1818.B2/..	318
1176/..	654	1423/..	298	1535.300/..	569	1755.ES50/..	611	1819.DOWN/..	646
1178/..	321	1424.300/..	568	1536.C.E27/..	671	1756.ES50/..	612	1819.UP/..	646
1226/..	690	1425/..	298	1538.B.E27/..	671	1757.CEN.7/..	409	1820/..	355
1233.300/..	566	1426.300/..	568	1539.A.E27/..	671	1758/..	368	1821.E27.250/..	207
1250/..	625	1427/..	298	1545LED/..	490	1759/..	368	1821.E27.300/..	207
1250C/..	625	1428/..	37	1546LED/..	490	1770.400/..	629	1821.E27.450/..	207
1261/..	616	1429/..	37	1547LED/..	490	1770.600/..	629	1821.E27.500/..	207
1263/..	616	1430LED/..	614	1548LED/..	490	1771.400/..	630	1823.AC.125/..	218
1267/..	616	1431LED/..	614	1555.B.E27/..	672	1771.600/..	630	1823.AC.250/..	218
1269/..	626	1433/..	49	1556.A.E27/..	672	1772.600/..	630	1823.AC.300/..	218
1270/..	626	1434/..	49	1557.N.E27/..	678	1772.900/..	631	1823.AC.450/..	218
1271/..	626	1435/..	334	1558.PE27/..	678	1772.1200/..	631	1823.AC.500/..	219
1271.ES63/..	626	1438/..	334	1559/..	59	1773.600/..	630	1823.AC.675/..	219
1280LED/..	628	1450/..	439	1562.N.E27/..	679	1773.900/..	631	1823.AC.900/..	219
1281LED/..	628	1451/..	439	1563.PE27/..	679	1773.1200/..	631	1824/..	322
1282LED/..	628	1466.300/..	570	1564.O.E27/..	679	1774.400/..	632	1824X3/..	322
1286/..	437	1467.C.E27.300/..	671	1590.N.E27/..	681	1775.400/..	632	1825/..	355
1287.ES50/..	435	1468.300/..	572	1591.PE27/..	681	1780.IP20/..	656	1826/..	322
1325.300/..	566	1469.300/..	572	1592.O.E27/..	681	1781.IP20/..	656	1826X3/..	322
1329/..	668	1472.1/..	326	1600/..	613	1782B.IP20/..	656	1827IP20/..	323
1338/..	668	1472.2/..	326	1602/..	613	1782.IP20/..	656	1827X3.IP20/..	323
1349/..	668	1472.3/..	326	1701.ES50/..	457	1783/..	655	1828.IP20/..	323
1350/..	299	1472.5/..	326	1702.ES50/..	457	1784/..	655	1828X3.IP20/..	323
1353/..	299	1482.1000/..	688	1703.ES50/..	457	1785/..	655	1829.IP20/..	324
1363/..	206	1485/..	690	1705.ES50/..	458	1799/..	633	1829X3.IP20/..	324
1364/..	206	1486/..	690	1706.ES50/..	458	1800/..	441	1830/..	699
1368/..	375-578	1487/..	308	1707.ES50/..	458	1801LED/..	388	1831/..	699
1369/..	375-578	1487LED/..	308	1711.ES50/..	459	1802.LED/..	388	1832/..	699
1373.300/..	571	1488/..	308	1712.ES50/..	459	1804.B3/..	320	1833.ES50.125/..	216
1377.300/..	571	1488.LED/..	308	1713.ES50/..	459	1804.TX/..	320	1833.ES50.250/..	216
1379.300/..	566	1489/..	309	1717.TCDE/..	612	1805.3/..	319	1833.ES50.300/..	216

1833.ES50.450/..	216	1875/..	464	1917.TX.E27/..	314	1988.IP20/..	485	2915/..	499
1833.ES50.500/..	217	1875.GU10/..	465	1917.TX.ES50/..	314	1989.IP20/..	485	2918.1400/..	504
1833.ES50.675/..	217	1876/..	464	1918.B2.E27/..	315	1994/..	655	2919.1400/..	504
1833.ES50.900/..	217	1876.GU10/..	465	1918.B2.ES50/..	315	2020/..	28	2920/..	498
1834.250/..	364	1877/..	464	1918.B3.E27/..	315	2024/..	57	2921.1000/..	504
1834.300/..	364	1877.GU10/..	465	1918.B3.ES50/..	315	2025/..	57	2922.1000/..	505
1834.400/..	364	1878/..	464	1919.E27/..	316	2026/..	29	2923.1400/..	505
1834.675/..	364	1878.GU10/..	466	1919.ES50/..	316	2029/..	27	2925/..	496
1834.900/..	365	1880/..	465	1920.E27/..	646	2029A/..	27	2930/..	498
1835.450/..	232	1880.GU10/..	466	1920.ES50/..	646	2031/..	28	2945.1400/..	504
1835.450.ES50/..	232	1885DS.ES50/..	460	1921.E27/..	647	2031A/..	27	2980/..	495
1836.300.ES50/..	230	1885.ES50/..	462	1921.ES50/..	647	2031B/..	27	2981/..	495
1836.450/..	231	1886DS.ES50/..	460	1922.3/..	226	2071/..	358	2985/..	495
1836.450.ES50/..	230	1886.ES50/..	462	1923.5/..	226	2072/..	358	2986/..	502
1836.675/..	231	1887DS.ES50/..	460	1924.7/..	226	2073/..	358	2987/..	495
1836.675.ES50/..	230	1887.ES50/..	462	1925.5/..	227	2073T/..	358	2988/..	502
1836.900/..	231	1888DS.ES50/..	461	1926.7/..	227	2074SQ/..	359	3004.DISCUS/..	171-658
1837.1000/..	137	1888.ES50/..	462	1927.11/..	221	2081/..	360	3004.JUPITER/..	172-658
1837C/..	366	1890DS.ES50/..	461	1930.B3/..	320	2082/..	360	3004.STEP/..	172-658
1837.ES50/..	363	1890.ES50/..	463	1930.TX/..	320	2083/..	360	3006/..	658
1837.SLA/..	363	1891/..	467	1952.XTM.M10/..	147	2083T/..	360	3006.T/..	659
1838.ES50.250/..	208	1892/..	467	1956/..	160	2084SQ/..	361	3007.DISCUS.25/..	659
1838.ES50.300/..	208	1893/..	467	1956.100/..	160	2100ALED/..	513	3007.JUPITER.25/..	659
1838.ES50.450/..	208	1894/..	467	1956.100.ES50/..	160	2101ALED/..	513	3007.STEP.25/..	659
1838.ES50.675/..	208	1895/..	563	1956.ES50/..	160	2102ALED/..	513	3008.DISCUS.45/..	660
1838.ES50.900/..	209	1896/..	563	1957/..	469	2103ALED/..	513	3008.JUPITER.45/..	660
1839/..	366	1897/..	564	1957.ES50/..	469	2106ALED/..	514	3008.STEP.45/..	660
1842.AC.250/..	210	1898/..	564	1958/..	697	2126LED/..	634	3010/..	652
1842.AC.300/..	210	1899/..	564	1958.ES50/..	697	2487/..	389	3010.ES50/..	652
1842.AC.450/..	210	1900/..	564	1958X/..	573	2487.LED/..	389	3011/..	652
1842.AC.500/..	210	1901/..	434	1958X.ES50/..	573	2488/..	389	3012/..	652
1843.E27.250/..	212	1902/..	434	1959A/..	469	2488.LED/..	389	3012.ES50/..	653
1843.E27.300/..	212	1903/..	434	1959A.ES50/..	469	2516BLED/..	508	3013/..	653
1843.E27.450/..	212	1904/..	434	1959B/..	470	2520CLED/..	508	3020/..	696
1844.ES50.250/..	213	1905/..	565	1959B.ES50/..	470	2524BLED/..	509	3021A/..	574
1844.ES50.300/..	213	1906/..	565	1960/./..	167	2528CLED/..	509	3021B/..	574
1844.ES50.450/..	213	1907.3/..	220	1961.ES50/..	159	2538.ALED/..	510	3022A/..	574
1846.AC.250/..	214	1908.5/..	220	1962.ES50/..	159-573	2546.CLED/..	510	3022B/..	574
1846.AC.300/..	214	1909.5/..	221	1969.IP20/..	486	2548BLED/..	508	3022C/..	575
1846.AC.450/..	214	1910.7/..	221	1976/..	100	2554.BLED/..	510	3023/./..	174
1847.E27.250/..	215	1911.E27/..	379	1977/..	100	2558CLED/..	508	3028/..	617
1847.E27.300/..	215	1911.ES50/..	379	1978/..	100	2595/..	512	3029/..	617
1847.E27.450/..	215	1912.E27/..	379	1979/..	100	2596/..	512	3030.LED/..	618
1848/..	563	1912.ES50/..	379	1980.IP20/..	483	2597/..	512	3032.LED/..	618
1849/..	563	1913.E27/..	380	1981.IP20/..	483	2598/..	512	3034.LED/..	618
1856.3/..	319	1913.ES50/..	380	1982.IP20/..	483	2601/..	515	3040LED/..	625
1856.E27.3/..	319	1914.E27/..	380	1983.IP20/..	483	2602/..	515	3041/..	625
1861/..	468	1914.ES50/..	380	1984.IP20/..	484	2603/..	515	3044.LED/..	605
1862/..	468	1915.E27/..	381	1985.IP20/..	484	2604/..	634	3045/..	620
1863/..	468	1915.ES50/..	381	1986.IP20/..	485	2900/..	496	3049/..	667
1868/..	468	1916.5/..	221	1987.IP20/..	485	2905/..	499	3050.LED/..	618

3052.LED/..	441	3243/..	392	3986M.100/..	142	4029/..	606	4110.IP20/..	480
3061W/..	450	3244/..	393	3986M.300/..	142	4029.2/..	606	4111.IP20/..	480
3062W/..	451	3245/..	393	3987M.B3/..	223	4030/..	698	4500/..	398
3063/..	449	3400.IP20/..	378	3987M.TX/..	223	4031/..	698	4501/..	398
3063.ZA/..	449	3401.IP20/..	378	3988.300/..	224	4032/..	606	4502/..	398
3064/..	449	3402/..	377	3988.400/..	224	4032.2/..	607	4503/..	398
3065A/..	450	3402.ES50/..	377	3988.500/..	224	4034/..	608	4503X/..	399
3065B/..	451	3403/..	377	3989M/..	145	4034.2/..	608	4504/..	399
3069/..	452	3404/..	290	3990.300/..	174-567	4035/..	608	4510/..	399
3071.XTM.B3/..	236	3404.B3/..	294	3999.G9.B3/..	329	4036/..	606	4511/..	399
3071.ZXO.B3/..	236	3405/..	289	4000.01/..	303	4040/..	333	4512/..	400
3076/..	627	3405.B3/..	292	4001.G4.B3/..	329	4041/..	333	4513/..	400
3076B/..	453	3406/..	289	4001.G9.B3/..	329	4051/..	245	4514/..	400
3079/..	453	3406.AR70/..	290	4002/./..	173	4052/..	245	4515/..	400
3081.10/..	650	3406.AR70.B3/..	292	4003.B3/..	321	4053/..	245	4520/..	404
3081.40/..	650	3406.B3/..	292	4004.B3/..	303	4054/..	246	4521/..	404
3082.10/..	650	3407/..	289	4006/..	333	4055/..	246	4522/..	405
3082.40/..	650	3407.B3/..	292	4007/..	333	4056/..	245	4523/..	405
3087B1/..	328	3408/..	604	4008/..	334	4057/..	244	4524/..	405
3087B3/..	328	3411/..	290	4009/..	334	4058/..	674	4525/..	405
3088.1W/..	175	3411.B3/..	294	4010/..	649	4059/..	387	4530/..	401
3088.3W/..	175	3412.3/..	295	4011/..	698	4063/..	387	4531/..	401
3089/..	328	3413.5/..	295	4012/..	698	4066/..	387	4532/..	401
3120/..	635	3414.3/..	295	4013.B3/..	304	4077/..	411	4533/..	401
3121/..	635	3415.5/..	295	4013.ES50.B3/..	304	4078/..	411	4534/..	402
3130/..	636	3416.3/..	296	4014.B3/..	304	4079/..	412	4535/..	402
3131/..	636	3417.3/..	296	4014.ES50.B3/..	304	4080/..	411	4536/..	402
3203/..	395	3418.5/..	296	4015.B3/..	305	4081.IP20/..	482	4537/..	402
3205/..	151	3500/..	311	4015.ES50.B3/..	305	4082.IP20/..	482	4538/..	403
3210/..	394	3500.B3/..	312	4016.B3/..	305	4083.IP20/..	482	4539/..	403
3211/..	394	3501/..	311	4016.ES50.B3/..	305	4084.IP20/..	482	4540/..	403
3212/..	394	3501.B3/..	312	4018.ES50/..	638	4085/..	411	4802/..	120
3213/..	394	3502/..	311	4020.ES50/..	638	4086.IP20/..	475	4803/..	120
3214/..	395	3502.B3/..	312	4024.G9.B3/..	325	4087.IP20/..	475	4804/..	120
3220/..	396	3902/..	306	4025.B3/..	325	4088.IP20/..	475	4805/..	121
3221/..	396	3903/..	306	4025.G9.B3/..	325	4089.IP20/..	475	4806/..	121
3222/..	396	3904/..	306	4025.W1/..	638	4090.IP20/..	157	4807/..	122
3223/..	396	3905/..	306	4025.W2/..	638	4091.IP20/..	476	4808/..	122
3224/..	397	3960.ES50.MR11/..	141	4026.B3/..	300	4092.IP20/..	476	4810/..	122
3225/..	397	3961/..	667	4026.G9.B3/..	300	4093.IP20/..	476	4811/..	124
3229/..	151	3980.300/..	225	4026.W1/..	637	4094.IP20/..	476	4813/..	124
3230/..	390	3980.400/..	225	4026.W2/..	637	4095.IP20/..	157	4814/..	124
3231/..	390	3980.500/..	225	4027B3/..	301	4096.IP20/..	478	4815/..	124
3232/..	390	3982M/..	142	4027G9.B3/..	301	4097.IP20/..	478	4816/..	125
3233/..	390	3983.200/..	367	4027W1/..	637	4098.IP20/..	478	4817/..	125
3234/..	391	3983.300/..	367	4027W2/..	637	4099.IP20/..	478	4820/..	120
3235/..	391	3983.400/..	367	4028.B3/..	302	4100.2000.48V/..	158	4970.B.E27/..	263
3240/..	392	3984/..	654	4028.G9.B3/..	302	4100.3000.48V/..	158	4971.B.E27/..	263
3241/..	392	3985M/..	141	4028X.B3/..	302	4100.IP20/..	157	4972.B.E27/..	263
3242/..	392	3986M/..	142	4028XLED.B3/..	302	4105.IP20/..	480	4973.C.E27/..	264

4974.C.E27/..	264	5003F.1/..	183	5043.E.E27/..	256	5085.40/..	199	5111.S/..	582
4975.C.E27/..	264	5003F.2/..	183	5044/..	472	5085.B.E27/..	258	5112.R/..	581
4977.7.LED/..	228	5003F.3/..	183	5045/..	472	5086.A.E27/..	258	5112.S/..	582
4977.13.LED/..	228	5003F.4/..	183	5046/..	472	5087.C.E27/..	254	5113.R/..	581
4980.E27/..	200	5004.E27B3/..	195	5047/..	474	5088.B.E27/..	254	5113.S/..	582
4981.E27/..	200	5005A/..	194	5048/..	474	5089.A.E14/..	255	5114.N/..	238
4982.E27/..	200	5005B/..	194	5049/..	474	5089.A.E27/..	254	5115.Q/..	238
4983.E27/..	200	5006/..	374	5050.5/..	372	5089.A.G9/..	255	5116.P/..	238
4984.SH.E27/..	202	5006.10/..	374	5051.B3/..	297	5090.G.E27/..	259	5120.N/..	239
4985.SH.E27/..	202	5007/..	193	5051.M10/..	297	5092.H.E27/..	259	5121.Q/..	239
4986.SH.E27/..	202	5008/..	373	5052/..	297	5093.C.E27/..	260	5122.P/..	239
4987.SH.E27/..	202	5009/..	373	5053/..	640	5094.B.E27/..	260	5123.N/..	240
4990.E27/..	203	5012/..	196	5054/..	640	5095.A.E14/..	261	5124.Q/..	240
4991.E27/..	203	5013/..	196	5055/..	641	5095.A.E27/..	260	5125.P/..	240
4992.E27/..	203	5014/..	44	5056/..	641	5095.A.G9/..	261	5126.A.E27SH/..	251
4995.A.E27SH/..	252	5015.2/..	196	5056.2SH/..	642	5096.C.E27/..	265	5127.E27/..	264
4996.A.E27SH/..	252	5015.3/..	196	5056.SH/..	642	5097.E27/..	257	5128.C.E27SH/..	250
4997.A.E27SH/..	252	5015.4/..	197	5057/..	641	5098.E27/..	257	5130.3N/..	241
4998.A.E27/..	262	5015.5/..	197	5057.2SH/..	642	5099.A.E14/..	258	5130.5N/..	242
4999.A.E27/..	262	5016.1/..	184	5057.SH/..	642	5100.2.XLC/..	351	5131.3Q/..	241
5001/..	374	5016.2/..	184	5058/..	372	5100.3.XLC/..	351	5132.3P/..	241
5001.10/..	374	5016.3/..	184	5058B/..	372	5100.3X.XLC/..	351	5132.5P/..	242
5001.E27.033/..	193	5016.4/..	184	5059/..	189	5100.4.XLC/..	351	5133.3N2P/..	242
5001.E27.037/..	193	5017.3/..	197	5060/..	688	5100.5.XLC/..	352	5134.2N3Q/..	243
5001.E27B3/..	193	5018.5/..	191	5061SH/..	643	5100.7.XLC/..	352	5135.1N2Q2P/..	243
5002.E27B3/..	195	5019.5/..	191	5062/..	688	5101.2.XLO/..	349	5143.1N1Q1P/..	243
5003A.1/..	179	5019.9/..	191	5063.C.E27SH/..	247	5101.3.XLO/..	349	5144.N/..	584
5003A.1.E40/..	188	5021/..	86	5064.B.E27SH/..	247	5101.3X.XLO/..	349	5144.P/..	584
5003A.2/..	179	5022/..	86	5065/..	189	5101.4.XLO/..	349	5146.N/..	584
5003A.2.E40/..	188	5023/..	86	5066/..	189	5101.5.XLO/..	350	5146.P/..	584
5003A.3/..	179	5024/..	86	5067.5/..	190	5101.7.XLO/..	350	5147.7/..	192
5003A.3.E40/..	188	5025/..	87	5067.7/..	190	5102/..	645	5149.9/..	192
5003A.4/..	179	5026/..	643	5067.9/..	190	5103.2.SC/..	347	5150.3C.E27/..	266
5003A.4.E40/..	188	5026SH/..	643	5068.C.E27SH/..	249	5103.3.SC/..	347	5150.5C.E27/..	266
5003B.1/..	180	5028/..	688	5069.B.E27SH/..	249	5103.3X.SC/..	347	5151.3C.SH/..	266
5003B.2/..	180	5031/..	332	5070/..	234	5103.4.SC/..	347	5151.5C.SH/..	266
5003B.3/..	180	5032/..	579	5071.B4/..	234	5103.5.SC/..	348	5152.3.E27/..	267
5003B.4/..	180	5034.2SH/..	644	5072/..	234	5104.2.SO/..	345	5152.5.E27/..	267
5003C.1/..	185	5034SH/..	644	5073.B4/..	234	5104.3.SO/..	345	5153.SH.5/..	267
5003C.2/..	185	5035SH/..	644	5074/..	369	5104.3X.SO/..	345	5154.4.E27/..	268
5003C.3/..	185	5036SH/..	644	5075/..	369	5104.4.SO/..	345	5155.7.E27/..	268
5003C.4/..	185	5037/..	371-640	5076/..	689	5104.5.SO/..	346	5156.3B.E27/..	269
5003D.1/..	186	5037.400/..	136	5077/..	689	5105.3/..	353	5156.5B.E27/..	269
5003D.2/..	186	5037.650/..	136	5078.C.E27SH/..	251	5105.5/..	353	5157.2E.3M/..	222-270
5003D.3/..	186	5037.800/..	136	5079.B.E27SH/..	251	5106/..	645	5158.2C.3M/..	222-270
5003D.4/..	186	5037X/..	136	5080.19/..	199	5107.5.B3/..	354	5159.2B.3C/..	270
5003E.1/..	182	5038/..	371	5080.31/..	199	5108.9.B3/..	354	5160.A/..	583
5003E.2/..	182	5038B/..	371	5081.16/..	199	5109.C.E27/..	256	5160.B/..	583
5003E.3/..	182	5040/..	161	5082.A.E27SH/..	247	5110.R/..	581	5161.A/..	583
5003E.4/..	182	5041/..	161	5083.A.E27SH/..	249	5110.S/..	582	5162.3E/..	269
5003.E27B3/..	187	5042/..	472	5084.C.E27/..	258	5111.R/..	581	5200.E27/..	376



5200.ES50/..	376	5805.600/..	621	8098/..	526	8230/..	537	8279/..	554
5201.E27.G80/..	580	5805.900/..	621	8107/..	537	8231/..	539	8281/..	527
5201.E27.G125/..	580	5805.1200/..	621	8108/..	537	8232/..	537	8285/..	555
5201.ES50/..	580	6500/..	175	8109/..	538	8233/..	538	8286/..	555
5226/..	456	7530/..	149	8110/..	126	8234/..	538	8287/..	555
5227.200/..	229	7531/..	149	8111/..	126	8235/..	539	8288/..	555
5227.300/..	229	7535/..	148	8112/..	129	8236/..	540	8289/..	534
5227.400/..	229	7536/..	148	8113/..	130	8237/..	540	8290/..	556
5228/..	368	7537/..	148	8114/..	130	8238/..	540	8291/..	556
5530.B/..	602	7538/..	148	8115/..	126	8239/..	541	8292/..	556
5531.A/..	602	7540/..	149	8116/..	538	8240/..	541	8293/..	556
5531.B/..	602	7541/..	149	8120/..	129	8241/..	542	8294/..	532
5533.B/..	603	7542/..	150	8121/..	129	8242/..	542	8295/..	532
5534.A/..	603	7543/..	150	8122/..	129	8243/..	543	8296/..	533
5534.B/..	603	7544/..	150	8125/..	130	8244/..	543	8297/..	533
5548.LED/..	275	7545/..	150	8126/..	130	8245/..	544	8298/..	533
5549.LED/..	277	7600.100.AC/..	146	8127/..	127	8246/..	544	8299/..	534
5550.E27/..	275	7600.700.DC/..	146	8128/..	128	8247/..	545	8300/..	546
5551.E27/..	278	7600.1200.DC/..	146	8135/..	127	8248/..	545	8315/..	413
5552.E27/..	278	7600.AC/..	146	8136/..	127	8249/..	545	8316/..	413
5553.E27/..	275	7603.AC/..	154	8137/..	127	8250/..	547	8317/..	413
5555.E27/..	279	7604.700.DC/..	154	8200/..	525	8251/..	547	8318/..	414
5556.E27/..	279	7605.1200.DC/..	154	8201/..	521	8252/..	547	8319/..	414
5557.E27/..	279	7606.ES50/..	154	8202/..	521	8253/..	547	8320/..	77-415
5558.E27/..	370	7700/..	143	8203/..	521	8254/..	548	8321/..	415
5559.E27/..	370	7701.B3/..	297	8204/..	521	8255/..	548	8322/..	415
5560.E27/..	675	7710/..	143	8205/..	524	8256/..	541	8323/..	415
5561.E27/..	675	7720/..	143	8206/..	524	8257/..	541	8324/..	77-416
5562.LED/..	676	7800/..	144	8207/..	524	8258/..	543	8325/..	77-416
5563.E27/..	676	7810/..	144	8208/..	522	8259/..	544	8326/..	416
5564.LED/..	676	7815/..	144	8209/..	522	8260A/..	548	8327/..	416
5565.E27/..	676	7820/..	144	8210/..	522	8260B/..	548	8328/..	418
5567.LED/..	278	7876.XTM/..	156	8211/..	529	8261/..	525	8329/..	418
5568.LED/..	278	7877/..	138	8212/..	529	8262/..	549	8330/..	418
5570.LED/..	280	7878/..	138	8213/..	529	8263/..	549	8331/..	418
5571.LED/..	280	7879/..	138	8214/..	529	8264/..	549	8332/..	419
5572.LED/..	280	7880.1300/..	140	8215/..	530	8265/..	549	8333/..	419
5573.LED/..	281	7880.2000/..	140	8216/..	530	8266/..	550	8334/..	420
5574.LED/..	281	7880.3000/..	140	8217/..	530	8267.M8X1/..	550	8335/..	420
5575.E27/..	282	7900/..	147	8218/..	531	8267.M10X1/..	550	8336/..	420
5576.E27/..	282	7901/..	147	8219/..	535	8268/..	551	8337/..	421
5577.E27/..	283	8080/..	132	8220/..	535	8269/..	551	8338/..	421
5578.E27/..	284	8082/..	132	8221/..	536	8270/..	550	8339/..	421
5579.E27/..	284	8083/..	132	8222/..	522	8271/..	551	8340/..	423
5580.LED/..	285	8085/..	133	8223/..	523	8272/..	531	8341/..	423
5581.LED/..	285	8086/..	133	8224/..	527	8273/..	553	8342/..	423
5582.E27/..	285	8087/..	133	8225/..	531	8274/..	553	8343/..	414
5583.E27/..	285	8088/..	133	8226/..	536	8275/..	553	8344/..	414
5584.E27/..	286	8095/..	526	8227/..	539	8276/..	553	8345/..	423
5585.E27/..	286	8096/..	526	8228/..	534	8277/..	554	461507/..	325
5805.300/..	621	8097/..	526	8229/..	536	8278/..	554	2338074/..	331



<b>A</b>		CLARA- B3	292-294	FLASH M10- M10	147	<b>J</b>	
AC_700_D24/..	115	CLARA-TX	289-296	FLAT SPRINGS	21	JACOB	141/226/367
AC_700_D36/..	115	CLARA XICATO	378	FLEX	173-326		654-667
ALFRED	668	CLARA XICATO- B3	292	FLEXLITTLECAPA	566-567	JACOB BRASS-TX	225
ANGELO	200-202	CLARA XICATO-TX	289	FLEXLITTLEJACOB	571-572	JACOBINE	404-405
APOLLO 230V	153	CLEO- B3	273	FLEXLITTLEJAMES	568-570	JACOB M- B3	223
AR62GU10/..	113	CLEO- M12	272/673	FLOU	368-456	JACOB M- M10	142
AR70GU10/..	113	CLEO- MOBY- M12	673	FLOU-TX	229	JACOB M- TX	223
ARC LED	605	C-LINE-TX	204	FOLIO 12V- M10	161	JACOB PENDEL-TX	224
<b>B</b>		CLIP DOUBLE	510	<b>G</b>		JAMES	664-665
BACCHUS	230-232	CLIP LED	508-509	GALAXY	199	JAMES WALL	576-577
BACH	228	COCTAIL 12V- M10	164	GALAXYWHEEL	199	JAZZ 12V- M10	164
BETAPLUS	457/459	COLIBRI 12V-M10	166	GASTON	562	JUBA	79
	610/696	COMMA	171-658	GEORGE	560	JUBA- M10	78
BLE-EWSDB/..	718	CONDOR 12V-M10	170	GL413G/..	331	JUBA SWIVEL	74-84
BLE-EWSSB/..	718	CONNECTOR	44	GL423S/..	330	JUBA ZT	82-83
BOOSTER	690	CONNECTOR TRACKS	47	GL1135S/..	330	JUBA ZT- M10	80-81
BRIDGE	441	CUBIC	427/696	GL2718CG/..	301	JUPITER 12V- M10	169
BRIDGE WALL	633	CUPIDO	424-426	GL5434WN/..	330	<b>K</b>	
BROOKLYN	654	<b>D</b>		GL5994CA/..	329	KABELGOOT TYPE	723-725
BUTTERFLY	507	DC_700_D24/..	116	GL8285BC/..	331	KG0../..	723-726
<b>C</b>		DC_700_D36/..	116	GL8285S/..	330	KNEEJOINT	46
CABLE	26	DC_1200_D24/..	116	GL8285W/..	331	KOBUS	606-608
CAKE	309	DC_1200_D36/..	116	GLASS G4-G9	329-331	KOX	368
CALYPSO	435	DECENTRALISATIESTEUN	44	GLOBO 12V- M10	163	<b>L</b>	
CAMELEON	362	DEMO TEXTIELCABLE	112	GOTA	355-699	LARA	613
CAMERA TWIN	442-443	DEMOWAAIER/..	112	GRAN CANARIA	614	LD220WCM/..	719
CAMERA UP	442	DISCOVERY 12V- M10	168	GUILIA	637	LED	113
CANARIA	614	DISCUS 12V- M10	167	GUILIA A- B3	300	LEDMODULE AC	115
CANVAS	413-620	DISCUS 230V- M10	152	GUILIA A- G9- B3	300	LEDMODULE DC	116
CAPA- B3	297	DISPLAY	658-660	GUILIA A spare glass	300	LEDMODULE T1	114
CAPA- M10	143-147	DOMINO 12V- M10	169	GUILIA B- B3	301	LINEA	512
CAPA X	146	DUO	650-651	GUILIA B- G9- B3	301	LIPSTICK	563-565
CAPA X- B3	297	<b>E</b>		GUILIA B spare glass	301	LOBBY	437
CAPA XL- M10	145	ENSOR	655	GUILIA C- B3	302	LOBBY	438
CAPA X- M10	144-297	ENSOR XICATO	656	GUILIA C- G9- B3	302	LOTUS	615
CAPRI 12V-M10	170	EQUAL	358-361	GUILIA C spare glass	301	LOTUS UP	615
CAPRI 230V- M10	153	<b>F</b>		<b>H</b>		LUNA- B3	303
CAPUCINE	398-400	F50/..	22	HANGOVER	307-690	LUXOR UP- M10	100
CAPUCINE XL	401-403	F70/..	22	HAVANA	616	LUXOR UP XICATO	482-486
CASAMBI	717-719	F111/..	22	HAVANA MIRROR	616	<b>M</b>	
CBU-A2D/..	717	FARFALLE	206-375-578	HI.60../..	152	MAESTRO	44/86-87
CBU-ASD/..	717	FARFALLE-TX	206	HI.63../..	152		189-191/371-374
CBU-TED/..	717	FELX LITTLE JACOB	571	HI.66../..	153		640-645
CHAIN- KETTING POLO	28	FILTER	22	HI.71../..	153	MAESTRO- B3	187-191
CIMBALO	311	FIXER	154-156	<b>I</b>		MAESTRO CARET-TX	185-186
CIMBALO- B3	312	FIXER- M10	154	INDY	629-632	MAESTRO CARET-TXW	186
CIRCUIT	29	FIXER XICATO	157/475-480			MAESTRO E40-TX	188
CLARA	377-604	FIXER XICATO 48V	158				

MAESTRO SHADE	193-197
MAESTRO- M10	136
MAESTRO SPIN- B3	192
MAESTRO-TX	179-184
MAESTRO-TXW	180-183
MAMBO	441
MAMBO LED	617-618
MANON	584/678-681
MANON	238-243
MANTA UP	444-446
MANTA UP DOUCHE	444-446
MAX	638
MAX- B3	325
MAX G9- M10	325
MAXI- B3	325
MAX spare glass	325
MERO	220/364
MERO 1FASE	120-125
MERO 3 FASE	126-131
MERO 48V	132-133
MERO 230V	137-366
MERO ES50	363
MERO BRASS-TX	215-219
MERO TX	207-214
MERO SLA	363
MERO SPOT	138
MERO XICATO	138-366
MERO XICATO 48V	140
MERO XICATO 700MA	138
METRO	27-29
METRO LED	513/634
MICRO	620
MIKADO	515
MIKADO WALL	634
MOBY	266-270
MOBY METAL-TX	265
MOBY- VOGUE	671
MONA	674
MONA- B3	244
MONA LISA	245-246
MONET	622-624
MONET CARR...	454
MONET	622-624
MONET ROND	448
MONET STRIP	455-623
MONTE CRISTO	698
DRIVER CASAMBI	719

<b>N</b>	
NAOMI	322-324
NCS COLOUR	20
NOA	304-306
NOA PC	638
NOTRE DAME	308-389
NOVA/..	117-118
NOVAFLAT/..	117
NOVA LED LENS	118
NOVASOFT/..	117

<b>O</b>	
OLIVIA	382/646
OLIVIA- B3	319
OLIVIA MINI	315/379
OLIVIA MINI	646-647
OLIVIA PENDEL	317-318
OMEGA	635
ONTARIO	581-582
OPERA	333/648/698
ORKA 9	328
ORKA	174-175
ORKA TABLE	696
ORKA WALL	574-575
OUTSIDER	625
OVALE BOX- M10	75-76

<b>P</b>	
P039/..	42-110-528
P040/..	43-110-528
P041/..	28
P042/..	28
PIVA	329-332
PIVA WALL	579
PLASTERKIT	29
PLAZA	435
POLINA	369/585/689
POLINA- B3	234
POLO	336/487/588/692
POLO- B3	341
PROJECTA	655
PULA	161-472-474
PULA- M10	161

<b>R</b>	
R1028/..	301
R1029/..	300
RAL COLOUR STOCK	20
RAYA	625
RAYA MINI	625
RETRO	439
RICHARD AR70	411

RICHARD AR111	411
RICHARD ES50	411
RICHARD SLA	412
RINGO	151/390
ROCKY	309-310
RONDO BOX	68-74
ROSETTE- B3	41/61
ROSETTE for B3	67
ROSETTE for chain	67
ROSETTE pendant- B3	60
ROSETTE-TX	50-55
ROSETTE HOOK	66-67
ROSETTE SCREWS	37
ROSETTE- M10	30-64
ROSETTE- M12	57
ROSETTE UP- M10	65
ROSETTE UP- TX	49

<b>S</b>	
S1/..	21
S2/..	21
S5/..	21
S6.00/..	29
SC-TI-CAS/..	719
SETTIGE/..	354
SET TORSION SPRINGS	21
S.EXTRA CIRCUIT/..	29
SHAKE GLASS	279-286
SHAKE METAL	285
SHAKE GLASS	602/675
SKIWE	203
SLO_T1_D15/..	114
SLO_T1_D30/..	114
SLO_T1_D36/..	114
SLO_T1_D45/..	114
SPACE	321
SPAZIO	667
SPAZIO LED- B3	236
SPINNER X	467-468
SPINNER X AR70	465-466
SPINNER X DS	460-461
SPINNER X FORUM	462-463
SQUARE 230V	96-98
STAALKABEL	28
STELLA	77/413-423
STELLA LINE	504-505
STEP 12V- M10- M10	168
STEP 230V- M10	152
STILETTO	521-551
STRAIN RELIEF	42/110/528

SURF	626
<b>T</b>	
TALLY- B3	298-299
TALLY-TX	299
TAO	636
TAVOLO	345-353
TAVOLO SETTIGE	354
TAVOLO SQ	354
TEXCABLE3X1,5/..	26
TEXO	88-90
TEXO- M10	91-94
TEXTILE CABLE	23-26
TEXW_3X1,5/..	26
THINDR	406-410
THINDR CROSS	409
TIMES CROSS	502
TIMES GRID	499
TIMES KADER	502
TIMES LED 45X45	496
TIMES LED 45X45 EXT	496
TIMES LED 45X70	498
TIMES LED 60X85	495
TIMES T5-60x85	495
TIMES T5-60X85	495
TITUS 230V	432
TITUS Round	433
TITUS SQ	434
TOLEDO	449-453
TOLEDO WALL	627
TONDO- B3	297
TONDO	148-150
TORPEDO	162-481
TRANSFOKAST	720-721
TR20X/..	720
TR30X/..	720
TR40X/..	721
TR60X/..	721
TR80X/..	721
TR127630/..	719
TRANSFORMER BOX	63
TREKONTLASTING	42/111
TUBA 12V- M10	166
TUBA- B3	321
TUBO	376-580
TWIPE- B3	320
TWIPE LED	388
TWIST 12V- B3	175

<b>U</b>					
UNO	650	W748.CH/..	339	W792/..	692
UTOPIE 12V- M10	162	W749.B3/..	339	W792B/..	692
<b>V</b>		W749.CH/..	339	W793/..	695
VEGA	621	W750/..	595	W797/..	692
VICTOR	151/394	W751/..	596	W797B/..	692
VIOLA 12V- M10	167	W752/..	596	W798/..	695
VITO	652-653	W753/..	596	W805.B3/..	341
VOGUE	683/684	W753.B/..	596	W1171/..	592
VOGUE XL	688	W754/..	597	W1190/..	600
VOLTA	469/573/697	W755/..	598	W1191/..	600
VOLTA + JUBA	469-470	W756/..	599	W1191.B/..	600
VOLTA M10	160	W757/..	599	W1192/..	600
VOLTA FLEX- M10	159-573	W757B/..	599	W1193/..	601
<b>W</b>		W758.B3/..	340	W1194/..	601
W730/..	588	W758.CH/..	340	W3061W/..	450
W731/..	588	W759.B3/..	340	W3062W/..	451
W731.B/..	588	W759.CH/..	340	W3064/..	449
W732/..	588	W760A/..	488	W3065A/..	450
W733/..	590	W761/..	694	W3065B/..	451
W733.S/..	590	W762/..	694	W3069/..	453
W734/..	590	W763/..	695	W3079/..	453
W734.S/..	590	W764/..	694	W3082.10/..	651
W735/..	592	W765/..	694	W3082.40/..	651
W736/..	592	W770/..	597	W3139/..	446
W737/..	594	W770.B/..	597	W3140/..	446
W737.B/..	594	W771/..	597	W3141/..	444
W738/..	594	W772/..	595	W3142/..	444
W738.B/..	594	W772.B/..	595	W3143/..	444
W740/..	487	W773/..	595	W3144/..	444
W741/..	487	W774.B3/..	338	W3145/..	446
W741.B/..	487	W774.CH/..	338	W3146/..	446
W742/..	489	W775.B3/..	342	W3409/..	604
W743.B3/..	336	W775.B.B3/..	342	WAVE	628
W743.B.B3/..	336	W775.B.CH/..	342	WING	490
W743.B.CH/..	336	W775.CH/..	341	<b>X</b>	
W743.CH/..	336	W776.B3/..	343	X-PRESS/..	718
W744.B3/..	338	W776.CH/..	342	<b>Z</b>	
W744.CH/..	338	W777/..	598	ZEN LED	628
W745.B3/..	341	W778/..	488	ZOOM BOX- M10	102
W745.CH/..	341	W779/..	489	ZOOMCLICK + VOLTA	428/431
W746.B3/..	343	W780/..	585	ZOOM- M10	102-104
W746.CH/..	343	W781/..	585	ZUMBA	320
W747.2.B3/..	344	W782/..	585		
W747.2.CH/..	344	W783/..	585		
W747B3/..	344	W785/..	586		
W747CH/..	343	W786/..	586		
W748.B3/..	339	W787/..	586		
		W788/..	586		









### **100% Belgische kwaliteit**

psmlighting is een Belgisch familiebedrijf. Zowel de ontwikkeling, de productie als de afwerking van onze verlichting gebeurt in ons eigen atelier. Daardoor geniet je van een op en top Belgisch product.

---

### **100% Belgian quality**

Psmlighting is a Belgian family business. We develop, produce and finish all our lighting in our own workshop. That's why you can enjoy a truly Belgian product.



vividly creating  
an absolute delight  
by magically blending  
a thousand shades of light

All information in this catalogue is without engagement and can always be modified. Psmlighting has the right to change the technical aspects of its products at any time without prior notice. All products are supplied without bulbs. This catalogue may not be reproduced without written authorization of Psmlighting bv.

All models: © copyright- Product design: Mortier Gerard- Mortier Saskia- Mortier Pieter

Copyright © September 2020 psmlighting bv | Langevoorde Groendreef 60 | BE 9880 Aalter | info@psmlighting.be  
Tel 0032 9 374 19 51 fax 0032 9 374 72 22 | www.psmlighting.be